

Order chart - Viking Xtreme Valves - Xtreme operating pressure / temperature

<b>P</b>	<b>2</b>	<b>L</b>	<b>A</b>	<b>X</b>	<b>5</b>	<b>1</b>	<b>1</b>	<b>E</b>	<b>S</b>	<b>H</b>	<b>D</b>	<b>D</b>	<b>B</b>	<b>4</b>	<b>9</b>
----------	----------	----------	----------	----------	----------	----------	----------	----------	----------	----------	----------	----------	----------	----------	----------

	<b>Valve family</b>
<b>P2L</b>	Viking inline valve

	<b>Size</b>
<b>A</b>	1/8
<b>B</b>	1/4
<b>C</b>	3/8
<b>D</b>	1/2

	<b>Version</b>
<b>X</b>	Xtreme duty spool

	<b>Port thread</b>
<b>11</b>	G1/8
<b>12</b>	G1/4
<b>13</b>	G3/8
<b>14</b>	G1/2
<b>91</b>	1/8 NPT
<b>92</b>	1/4 NPT
<b>93</b>	3/8 NPT
<b>94</b>	1/2 NPT

	<b>Solenoid pilot type</b>
<b>H<sup>1</sup></b>	16 bar / -40°C to 60°C

<sup>1</sup> Solenoid operated 'H' version supplied with B type enclosure 16 bar solenoid











  

	<b>Solenoid exhaust</b>
<b>D</b>	Vented
<b>N</b>	Capture/tapped M5

	<b>Overrides</b>
<b>D</b>	Extended non-locking

<b>Valve type function</b>		
<b>Solenoid operated with internal supply to solenoid</b>		
<b>3</b>		3/2 valve
<b>5</b>		5/2 valve
<b>6</b>		5/3 valve closed centre position
<b>7</b>		5/3 valve pressurised centre
<b>8</b>		5/3 valve vented centre
<b>Solenoid operated with external pilot supply to solenoids through ports 10 &amp; 12 for 3/2 version and through ports 12 &amp; 14 for 5/2 &amp; 5/3 version</b>		
<b>L</b>		3/2 valve
<b>N</b>		5/2 valve
<b>P</b>		5/3 valve closed centre position
<b>Q</b>		5/3 valve pressurised centre
<b>R</b>		5/3 valve vented centre

	<b>Pilot main actuator / Return</b>
<b>E</b>	Solenoid operated valve
<b>S</b>	Spring (return only)
<b>P</b>	Press (return only)

	<b>Solenoid enclosure / Lead length</b>
<b>A</b>	22mm Solenoid pilot & 30mm coil Form A
<b>B</b>	22mm Solenoid pilot & 22mm coil Industrial Form B
<b>N</b>	22mm Solenoid pilot less coil

<b>Voltage <sup>3</sup></b>		
	<b>AC</b>	<b>DC</b>
	<b>60Hz</b>	<b>50Hz</b>
<b>40</b>	12	
<b>42</b>	24	22
<b>45</b>		12
<b>47*</b>		12
<b>48*</b>		24
<b>49</b>		24
<b>53</b>	120	110
<b>57</b>	240	230
<b>72</b>		110
<b>XX</b>	valve less solenoid/coil	

<sup>3</sup> Mobile voltage see page 51 operating parameters

<sup>3</sup> Shaded part numbers are available from stock  
 Unshaded part numbers are available on request but will be subject to minimum order quantities  
 Otherwise order coil and valve separately.







Shaded part numbers are standard

## Solenoid operated directional control valves - Xtreme duty -40°C to +60°C

## P2LAX/P2LBX - 16 bar, P2LCX/P2LDX - 12 bar

Complete with 22mm solenoid and 24V DC coil.

Internal supply to solenoid valve(s) via port 1. Connector/cable plugs to be ordered separately.

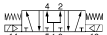
Symbol	Size	Actuation	Return	Min Operating Pressure (bar)	Changeover time (ms) at 6 bar @20°C actua./return	Weight Kg	Order code
<b>3/2 valves, internal air, low temperature</b>							
	G1/8	Electric signal	Electric signal	1,5	11/11	0,42	<b>P2LAX311EEHDDDB49</b>
	G1/4		Low temp.	1,5	13/13	0,42	<b>P2LBX312EEHDDDB49</b>
	G3/8			1,5	18/18	0,48	<b>P2LCX313EEHDDDB49</b>
	G1/2			1,5	18/18	0,48	<b>P2LDX314EEHDDDB49</b>
	G1/8	Electric signal	Spring	3,2	15/45	0,38	<b>P2LAX311ESHDDDB49</b>
	G1/4		Low temp.	3,5	25/65	0,38	<b>P2LBX312ESHDDDB49</b>
	G3/8			3,5	25/85	0,46	<b>P2LCX313ESHDDDB49</b>
	G1/2			3,5	25/85	0,46	<b>P2LDX314ESHDDDB49</b>
<b>5/2 valves, internal air, low temperature</b>							
	G1/8	Electric signal	Electric signal	1,5	11/11	0,27	<b>P2LAX511EEHDDDB49</b>
	G1/4		Low temp.	1,5	13/13	0,42	<b>P2LBX512EEHDDDB49</b>
	G3/8			1,5	18/18	0,48	<b>P2LCX513EEHDDDB49</b>
	G1/2			1,5	18/18	0,48	<b>P2LDX514EEHDDDB49</b>
	<b>G1/8</b>	<b>Electric signal</b>	<b>Spring</b>	<b>3,2</b>	<b>15/45</b>	0,22	<b>P2LAX511ESHDDDB49</b>
	G1/4		<b>Low temp.</b>	3,2	20/55	0,38	<b>P2LBX512ESHDDDB49</b>
	G3/8			3,2	25/85	0,46	<b>P2LCX513ESHDDDB49</b>
	G1/2			3,2	25/85	0,46	<b>P2LDX514ESHDDDB49</b>
<b>5/3 valves, internal air, low temperature</b>							
	G1/8	Electric signal	Electric signal	3,5	18/50	0,28	<b>P2LAX611EEHDDDB49</b>
	G1/4	Closed centre	Self	3,5	25/65	0,45	<b>P2LBX612EEHDDDB49</b>
	G3/8	position	centring	3,5	30/90	0,55	<b>P2LCX613EEHDDDB49</b>
	G1/2		Low temp.	3,5	30/95	0,55	<b>P2LDX614EEHDDDB49</b>
	G1/8	Electric signal	Electric signal	3,5	18/50	0,28	<b>P2LAX811EEHDDDB49</b>
	G1/4	Vented centre	Self	3,5	25/65	0,45	<b>P2LBX812EEHDDDB49</b>
	G3/8	position	centring	3,5	30/90	0,55	<b>P2LCX813EEHDDDB49</b>
	G1/2		Low temp.	3,5	30/95	0,55	<b>P2LDX814EEHDDDB49</b>
	G1/8	Electric signal	Electric signal	3,5	18/50	0,28	<b>P2LAX711EEHDDDB49</b>
	G1/4	Pressurised	Self	3,5	25/65	0,45	<b>P2LBX712EEHDDDB49</b>
	G3/8	centre	centring	3,5	30/90	0,55	<b>P2LCX713EEHDDDB49</b>
	G1/2	position	Low temp.	3,5	30/95	0,55	<b>P2LDX714EEHDDDB49</b>

Dimensions

P2LAX... all

5/2 and 5/3 valves

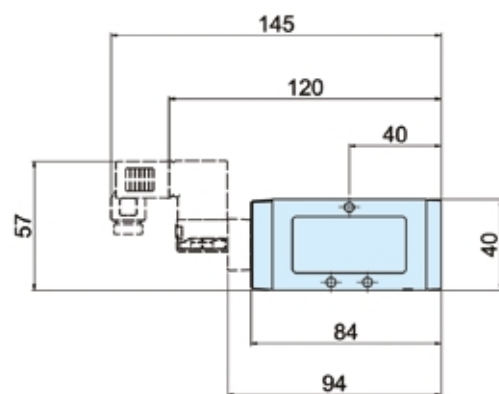
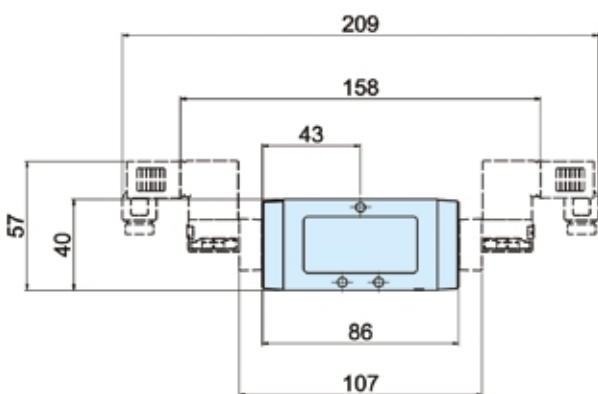
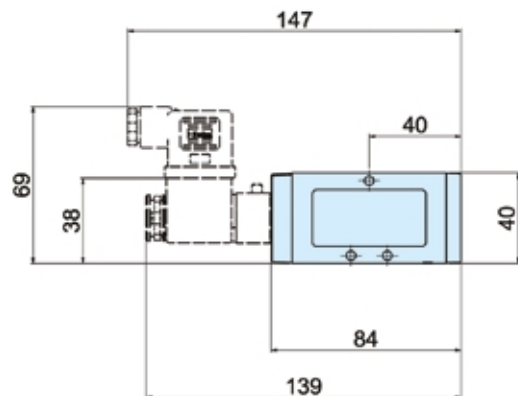
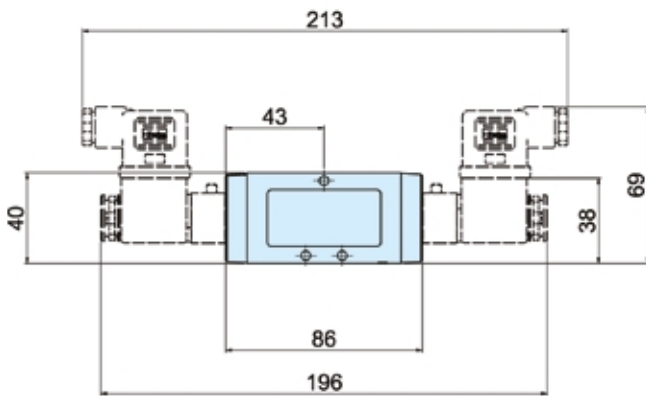
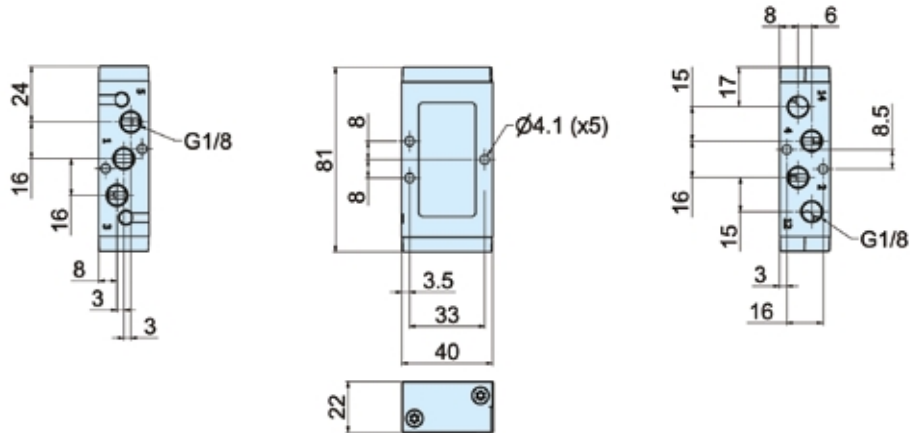

Solenoid valves

Cable plugs must be ordered separately.

One pilot valve is required for each E in the valve order code.

**P2LAX, flexible manifold assembly**

A practical system solution with the aid of connection pieces. The manifolds can easily be assembled from the top to form a compact and stable block. The block can then be installed in cabinets or directly on the machine frame as shown in the example in the bottom of this page.

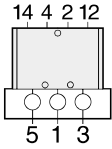

**Valve:**  
with cylinder ports 2 and 4 and signal ports 12 and 14 facing upwards, enabling easily access to connection ports. All ports are G1/8 threaded to simplify choice of connectors.

**Manifold:**  
with common channels for ports 1, 3 and 5.

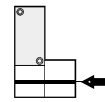
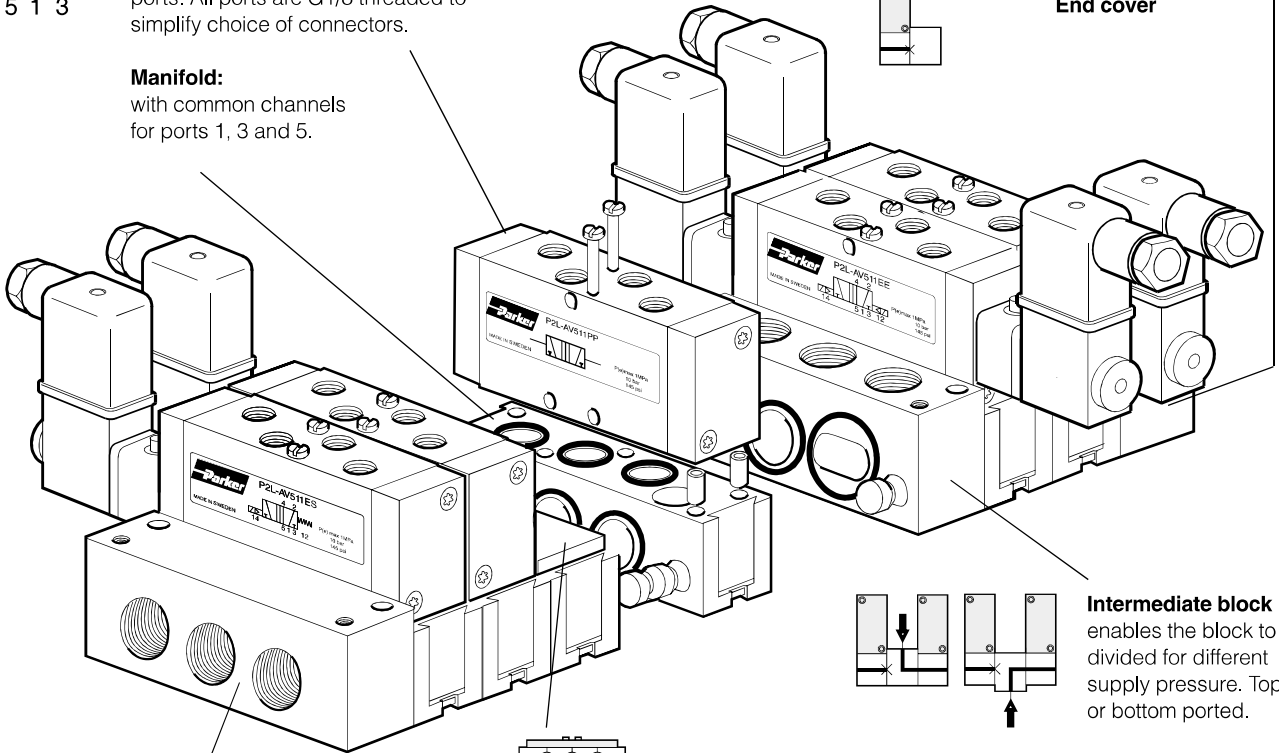

**Connection block S:**  
straight connection block with a side ports for common air supply and exhaust.

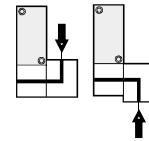

**Connection block L:**  
angled connection block for top or bottom ported.

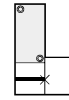

**End cover**

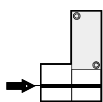

**Connection block S:**  
straight connection block with a side ports for common air supply and exhaust.

**Blanking plate:**  
To incorporate spare positions.

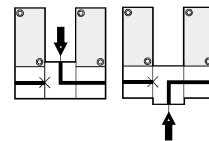

**Intermediate block L:**  
enables the block to be divided for different supply pressure. Top or bottom ported.

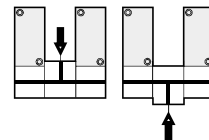

**Intermediate block T:**  
permits the connection of air between two manifolds. Top or bottom ports.

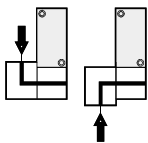

**Connection block L:**  
angled connection block for top or bottom ported.

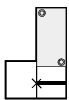

**End cover**

**Various mounting options**

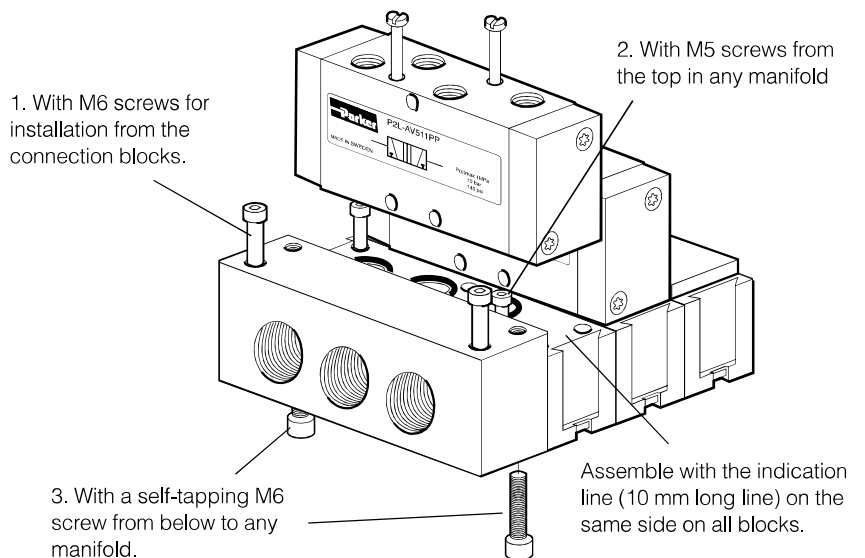

Dimensions

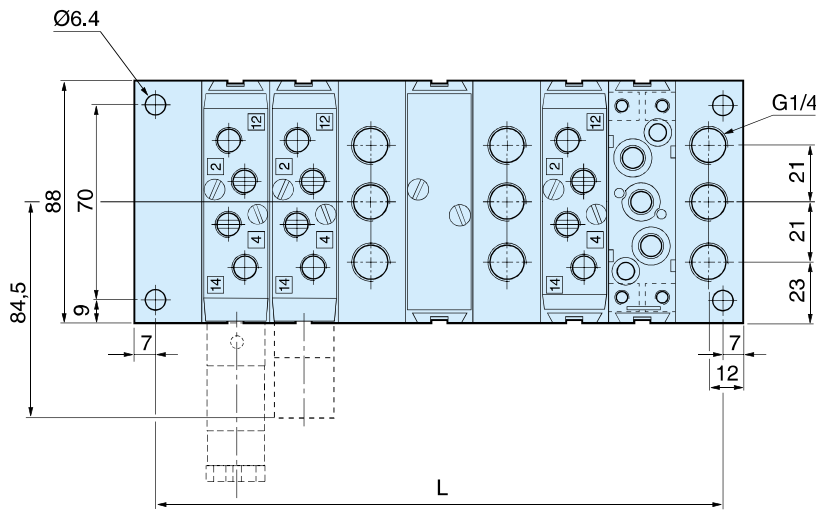

$$L = 34 + (\text{Number of manifolds and Intermediate blocks} \times 24)$$

Connection block L and intermediate blocks L and T can be turned so that connection can be made from above or below.  
 Multiple manifolds must be fitted with the top indication line (a 10 mm long line) facing the same side on all manifolds.

