

Solenoid operated valves 2-way 2-positions
Common cavity size 08
Cartridge style in manifold

VEI-CS-16-08A

OS.15 - K - 18 - X - Y - Z - W

RE 18331-65

Edition: 02.2019

Replaces: 12.2016

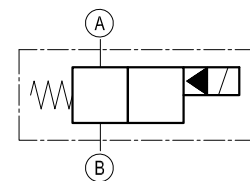
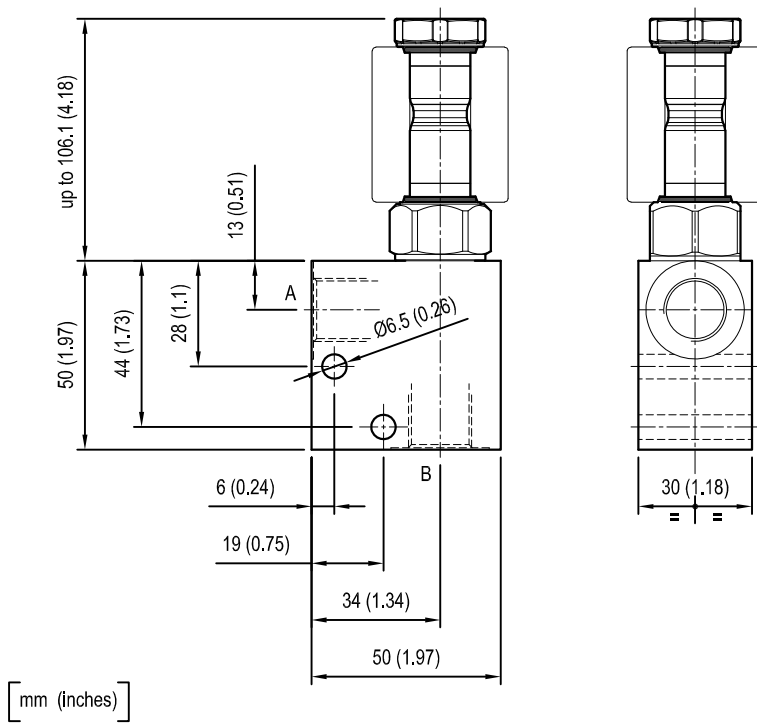

Cartridge schemes (K)

monodirectional type	bidirectional type
01	05
02	06
07	31
08	32

Technical data

Max. flow	40 l/min (11 gpm)
Max. operating pressure for steel body	350 bar (5000 psi)
Max operating pressure for aluminium body	210 bar (3000 psi)
Ambient temperature range	-30 to 90 °C (-22 to 194 °F)
Fluids: Mineral-based or synthetics with lubricating properties at viscosities of 20 to 380 mm ² /s (cSt)	
MTTFd	150 years see RE 18350-51
To order manifold only, see data sheet RE 18325-85	
Other technical data	See data sheet 18350-50

Ordering code

OS.15	K	18	X	Y	Z	W
-------	---	----	---	---	---	---

Solenoid operated valves
2-way 2-positions
Common cavity size 08
Cartridge style in manifold

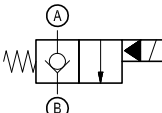
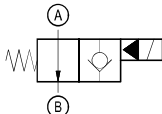
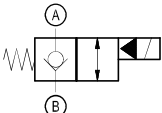
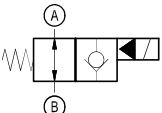
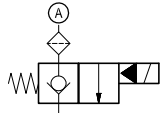
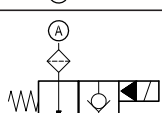
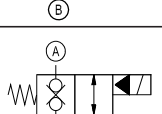
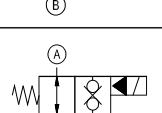
	01
	02
	05
	06
	07
	08
	31
	32

Manifold material

00	Aluminium
S0	Steel

Manifold port sizes

09	G 1/4
02	G 3/8
11	M 14x1.5

Cartridge seals and accessories options

- 0 = With buna seal
- V = With Viton seal
- P = With buna seal and protective cap for override version B, C and D
- T = With Viton seal and protective cap for override version B, C and D

Cartridge options

- A = Standard
- B = Push style manual override
- C = Push and twist style manual override
- D = Knob style manual override
- E = Pull style manual override
- F = Hand operated pull style manual override

Common cavity size 08

Note: for solutions availability (K-X-Y combinations), please refer to TAB.1 on page 2.

Bosch Rexroth Oil Control S.p.A.

Via Leonardo da Vinci 5
P.O. Box no. 5
41015 Nonantola – Modena, Italy
Tel. +39 059 887 611
Fax +39 059 547 848
compact-hydraulics-hic@boschrexroth.com
www.boschrexroth.com/compacthydraulics

© This document, as well as the data, specifications and other information set forth in it, are the exclusive property of Bosch Rexroth Oil Control S.p.a.. It may not be reproduced or given to third parties without its consent. The data specified above only serve to describe the product. No statements concerning a certain condition or suitability for a certain application can be derived from our information. The information given does not release the user from the obligation of own judgment and verification. It must be remembered that our products are subject to a natural process of wear and aging. Subject to change.

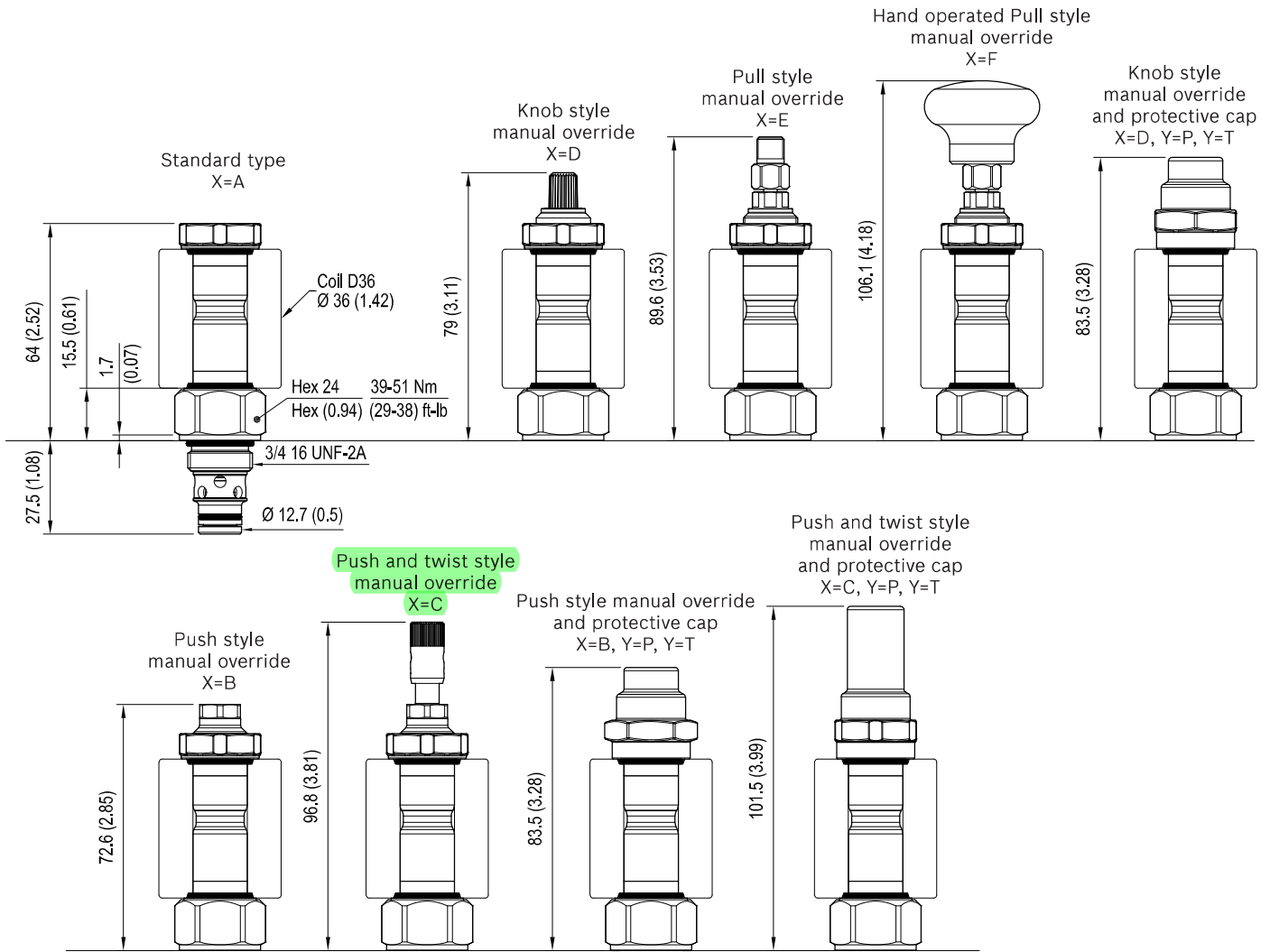

Cartridge technical data

General	
Installation orientation	Unrestricted
Ambient temperature range	-30 to 90 °C (-22 to 194 °F)
Hydraulic	
Max. operating pressure	350 bar (5000 psi)
Flow range	0.5 - 40 l/min (0.1 - 11 gpm)
Max. internal leakage	5 drops/min.
Switching time	Opening ≤ 50 ms Closing ≤ 100 ms
Fluid temperature range	-20 to 80 °C (-4 to 176 °F)
Fluids: Mineral-based or synthetics with lubricating properties at viscosities of 20 to 380 mm ² /s (cSt)	
Installation torque	39 - 51 Nm (29 - 38 ft-lbs)
Recommended degree of fluid contamination	Nominal value max. 10 µm (NAS 8) ISO 4406 19/17/14
MTTFd	150 years see RE 18350-51
Cavity	CA-08A-2N see data sheet 18325-70
Other technical data	See data sheet 18350-50

Electrical	
Type of voltage	DC voltage
Coil type	D36
Supply voltage	See data sheet 18325-90
Voltage tolerance against ambient temperature	See characteristic curve
Power consumption	20 W
Type of protection	See data sheet 18325-90

Note: Coils must be ordered separately

TAB. 1		Manual override options (X)					
		A	B	C	D	E	F
Seal and prot. cap. (Y)	O	K=all versions	K=02; K=06 K=08; K=32	K=02; K=06 K=08; K=32	K=01; K=05 K=07; K=31	K=01; K=05 K=07; K=31	K=01; K=05 K=07; K=31
	V	K=all versions	K=02; K=06 K=08; K=32	K=02; K=06 K=08; K=32	K=01; K=05 K=07; K=31	K=01; K=05 K=07; K=31	K=01; K=05 K=07; K=31
	P	/	K=02; K=06 K=08; K=32	K=02; K=06 K=08; K=32	K=01; K=05 K=07; K=31	/	/
	T	/	K=02; K=06 K=08; K=32	K=02; K=06 K=08; K=32	K=01; K=05 K=07; K=31	/	/