

Ordering Code and Characteristics

Model No.

T6GCC - B22 - B08 - 6 R 00 - B 1 - 00

Series



Cam ring for "P1" & "P2"

- (Delivery at 0 bar & 1500 r.p.m.)
- B03 = 16,2 l/min B17 = 87,4 l/min
 - B05 = 25,8 l/min B20 = 95,7 l/min
 - B06 = 31,9 l/min B22 = 105,4 l/min
 - B08 = 39,6 l/min **B25 = 118,9 l/min**
 - B10 = 51,1 l/min B28 = 133,2 l/min
 - B12 = 55,6 l/min B31 = 150,0 l/min
 - B14 = 69,0 l/min**

Type of shaft

6 = splined (DIN 5462)

Direction of rotation (view on shaft end)

R = clockwise

L = counter-clockwise

Modification

Mounting W/connection variables

	P1 = 1" - S = 3"	P1 = 1" - S = 2.1/2"2)
Code	00-0M	01-M0
P2	1"	3/4" 1)

0 = UNC thread M = metric thread

1) for 46 ml/rev. max.

2) for 126 ml/rev. max.

The larger cartridge must always be mounted in the front.

Seal class

1 = S1 - BUNA N

Design letter

Porting combination

00 = standard

P = Pressure port
S = Suction port

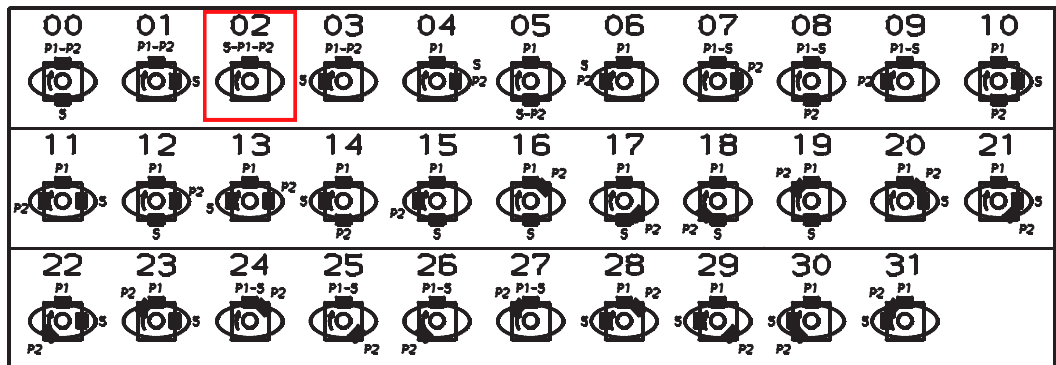

OPERATING CHARACTERISTICS - TYPICAL [24 cSt]

Series	Volumetric Displacement Vi	Speed n [R.P.M.]	Flow Q [l/min]			Input power P [kW]		
			p = 0 bar	p = 140 bar	p = 240 bar	p = 7 bar	p = 140 bar	p = 240 bar
B03	10,8 ml/rev	1000	10,8	-	-	1,0	-	-
		1500	16,2	10,7	-	1,3	5,3	-
B05	17,2 ml/rev	1000	17,2	11,7	-	1,1	5,1	-
		1500	25,8	20,3	15,8	1,4	7,5	12,2
B06	21,3 ml/rev	1000	21,3	15,8	11,3	1,1	6,0	10,0
		1500	31,9	26,5	22,0	1,5	8,9	14,7
B08	26,4 ml/rev	1000	26,4	20,9	16,4	1,2	7,2	12,1
		1500	39,6	34,1	29,6	1,6	10,7	17,7
B10	34,1 ml/rev	1000	34,1	28,6	24,1	1,3	8,9	15,1
		1500	51,1	45,7	41,2	1,7	13,4	22,3
B12	37,1 ml/rev	1000	37,1	31,6	27,1	1,3	9,6	16,3
		1500	55,6	50,2	45,7	1,7	14,4	24,1
B14	46,0 ml/rev	1000	46,0	40,5	36,0	1,4	11,7	19,9
		1500	69,0	63,5	59,0	1,9	17,6	29,5
B17	58,3 ml/rev	1000	58,3	52,8	48,3	1,6	14,5	24,8
		1500	87,4	82,0	77,5	2,1	21,9	36,9
B20	63,8 ml/rev	1000	63,8	58,3	53,8	1,6	15,8	27,0
		1500	95,7	90,2	85,7	2,2	23,8	40,2
B22	70,3 ml/rev	1000	70,3	64,8	60,3	1,7	17,3	29,6
		1500	105,4	100,0	95,5	2,3	26,1	44,1
B25 ¹⁾	79,3 ml/rev	1000	79,3	73,8	69,3	1,8	19,3	33,2
		1500	118,9	113,5	109,0	2,5	29,2	49,5
B28 ¹⁾	88,8 ml/rev	1000	88,8	83,3	80,1 ²⁾	1,9	21,9	32,5 ²⁾
		1500	133,2	127,7	124,5 ²⁾	2,8	32,7	48,5 ²⁾
B31 ¹⁾	100,0 ml/rev	1000	100,0	94,5	91,3 ²⁾	2,0	24,4	36,4 ²⁾
		1500	150,0	144,5	141,3 ²⁾	2,8	36,5	54,4 ²⁾

¹⁾ B25 - B28 - B31 = 2500 R.P.M. max.

²⁾ B28 - B31 = 210 bar max. int.

- Not to use if the internal leakage is greater than 50% of the theoretical flow.

INTERNAL LEAKAGE (TYPICAL)

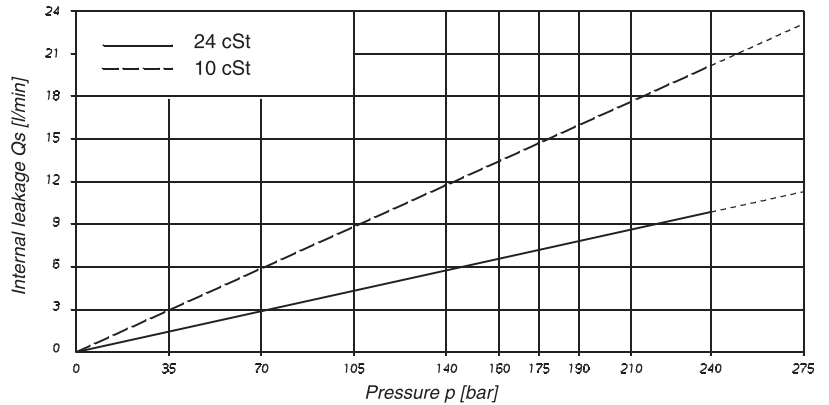

NOISE LEVEL (TYPICAL)
T6GCC - B22 - B22

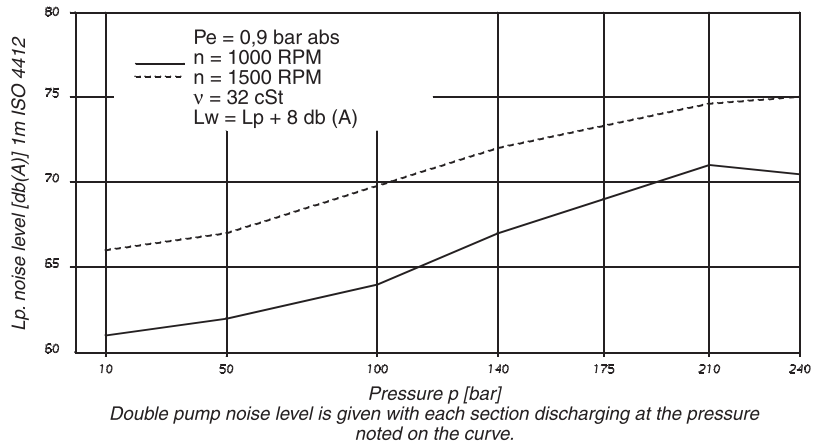

POWER LOSS HYDROMECHANICAL (TYPICAL)

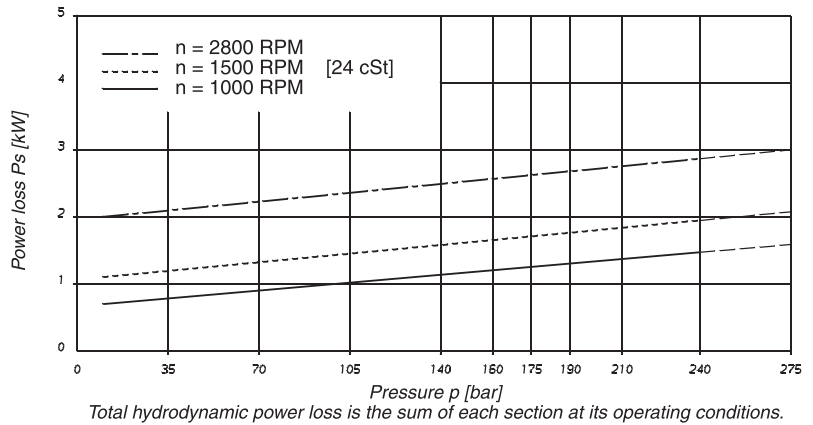

PERMISSIBLE RADIAL LOAD - T6GCC

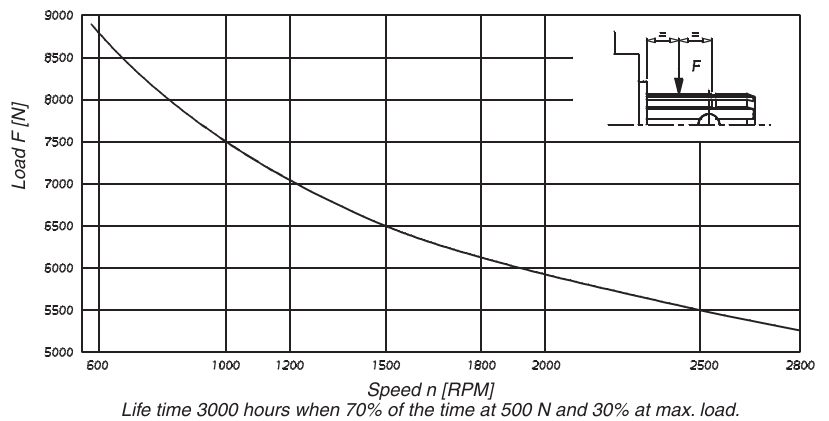

Weight 27.2 kg

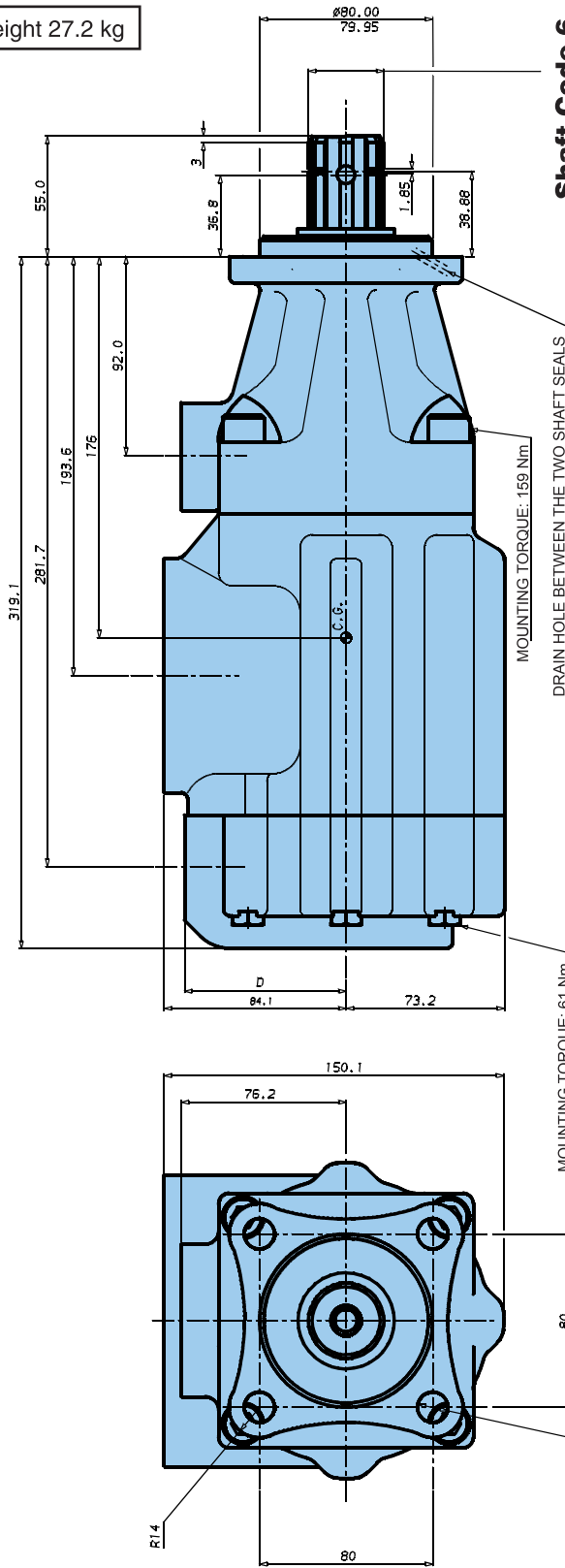

Shaft Code 6

(DIN 5462 B8-32-36)

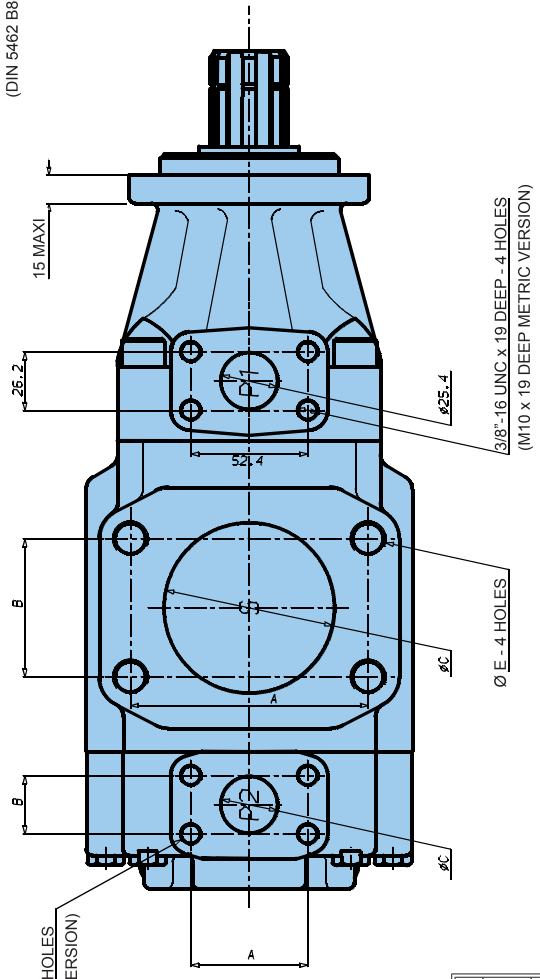

Shaft torque limits [ml/rev. x bar]	
Pump	Shaft
T6GCC	6
32670	

Port	Code	A	B	C	D	E
S	3"	106.4	61.9	76.2		5/8" - 11 x 28.4 deep M16 x 28.4 deep - metric version
S	2-1/2"	88.9	50.8	63.5		1/2" - 13 x 23.9 deep M12 x 23.9 deep - metric version
P1	1"	52.4	26.2	25.4	76.2	
P2	3/4"	47.7	22.4	19.0	76.2	
P2	1"	52.4	26.2	25.4	74.7	