

Features

**Torqmotor
Series TG**

- **Langsamlaufender Gerotor-Motor**
- **Spezielle Orbital-Steuerung**
Geringe interne Leckage
Hoher volumetrischer Wirkungsgrad
- **Rollen im Rotorsatz**
Reduzierte Reibung
Lange Lebensdauer
- **Patentierter Hochdruckwellendichtung**
Keine Leckölleitung
Keine Rückschlagventile
- **Vielzahl von Varianten**
Großer Einsatzbereich

- **Moteur lent système Gerotor**
- **Une distribution orbitale particulière assure**
fuites internes minimales
rendements volumétriques élevés
- **Le rotor à rouleaux**
réduit les frottements
augmente la durée de vie
- **Par l'utilisation de joints d'arbre haute pression brevetés**
pas de conduite de drainage
pas de clapets anti-retour
- **Grâce à de nombreuses variantes**
larges domaines d'application

- **Low Speed Gerotor Motor**
- **Zero leak commutation valve**
For greater, more consistent volumetric efficiency
- **Roller vane rotor set**
Reduces friction and internal leakage
Maintaining efficiency throughout the life of the motor
- **A patented high-pressure shaft seal**
No check valves needed
No extra plumbing
- **Wide choice of displacement range, flange and shaft options**
Greater efficiency in systems design to suit your application

- **Motore orbitale a bassa velocità**
- **Una particolare distribuzione orbitale assicura**
trafilamento ridotto
elevato rendimento volumetrico
- **Con lo statore a rullini**
si riduce l'attrito interno
si mantiene nel tempo l'efficienza del motore
- **Una guarnizione di tenuta ad alta pressione brevettata elimina la necessità**
di una linea di drenaggio esterna
e di valvole di non ritorno
- **Un'ampia gamma di cilindrata, flange ed alberi**
consentono scelte adeguate ad ogni esigenza costruttiva

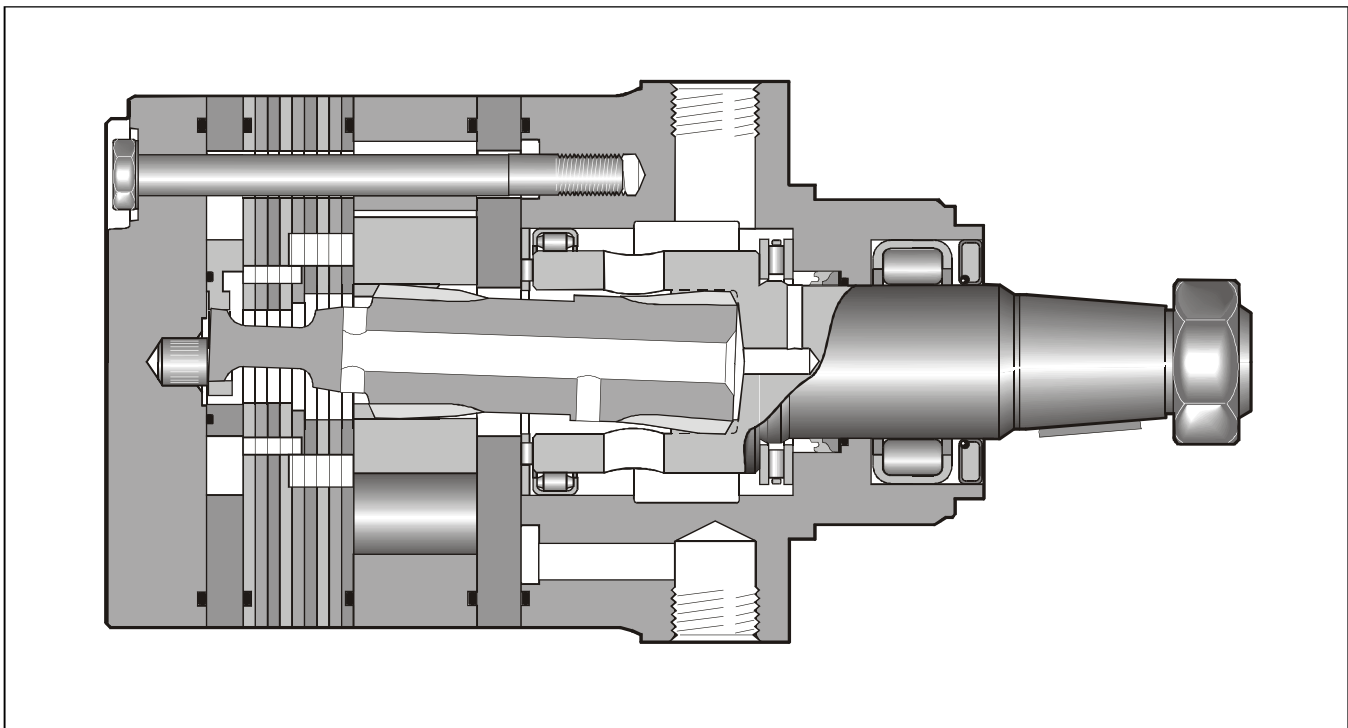

Torqmotoren 3213.PM6.5 RH

Performance

**Torqmotor
Series TG**

Drehzahl Speed Vitesse de rotation Velocità di rotazione	5...710 rev/min
Schluckstrom Oil flow Débit d'huile Portata	max. 115 l/min
Eingangsdruck Supply pressure Pression entrée Pressione in entrata	max. 300 bar
Drehmoment Torque Couple Coppia	max. 1490 Nm
Seitenlast Side load Charges latérales Carico radiale	max. 16.000 N

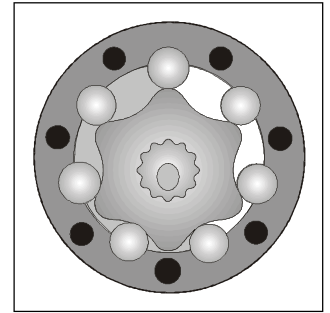
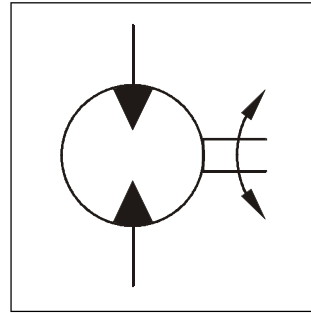

Motor series TG	cm ³ /U cm ³ /rev cm ³ /tr cm ³ /giro	cont / int U/min rev/min tr/min giri/min	cont / int l/min	cont / int bar	max bar	cont / int Nm	cont / int max. KW	cont / int Nm
TG 140	140	530/710	75/100	200/280	300	400/ 545	33	320/436
TG 170	169	440/575	75/100	200/280	300	485/ 670	33	388/536
TG 195	195	380/510	75/100	200/280	300	560/ 770	33	448/616
TG 240	237	320/420	75/100	200/280	300	685/ 945	32	548/756
TG 280	280	270/350	75/100	200/280	300	800/1100	31	640/880
TG 335	337	225/290	75/100	200/280	300	980/1350	30	784/1080
TG 405	405	185/245	75/100	170/240	300	960/1350	27	768/1080
TG 475	476	160/240	75/115	140/200	300	960/1400	28	768/1120
TG 530	529	140/215	75/115	140/170	300	1050/1280	23	840/1024
TG 625	624	120/185	75/115	120/160	300	1040/1360	20	832/1088
TG 785	786	95/145	75/115	100/140	300	1150/1490	17	920/1192
TG 960	958	78/119	75/115	70/100	300	925/1390	12	740/1112

int. =

Intermittierende Werte maximal: 10% von jeder Betriebsminute.

Intermittent operation rating applies to 10% of every minute.

Fonctionnement interm.: 10% max. de chaque minute d'utilisation.

Servizio intermittente: 10% max di ogni minuto di utilizzazione.

Torqmotoren 3213.PM6.5 RH

Code E

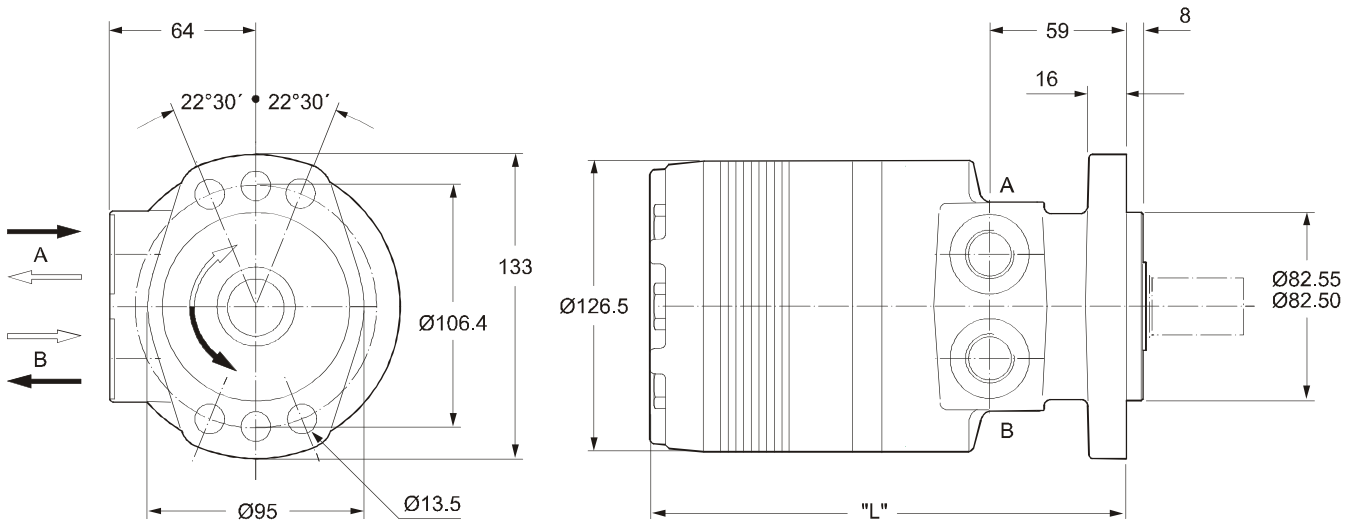

Code M

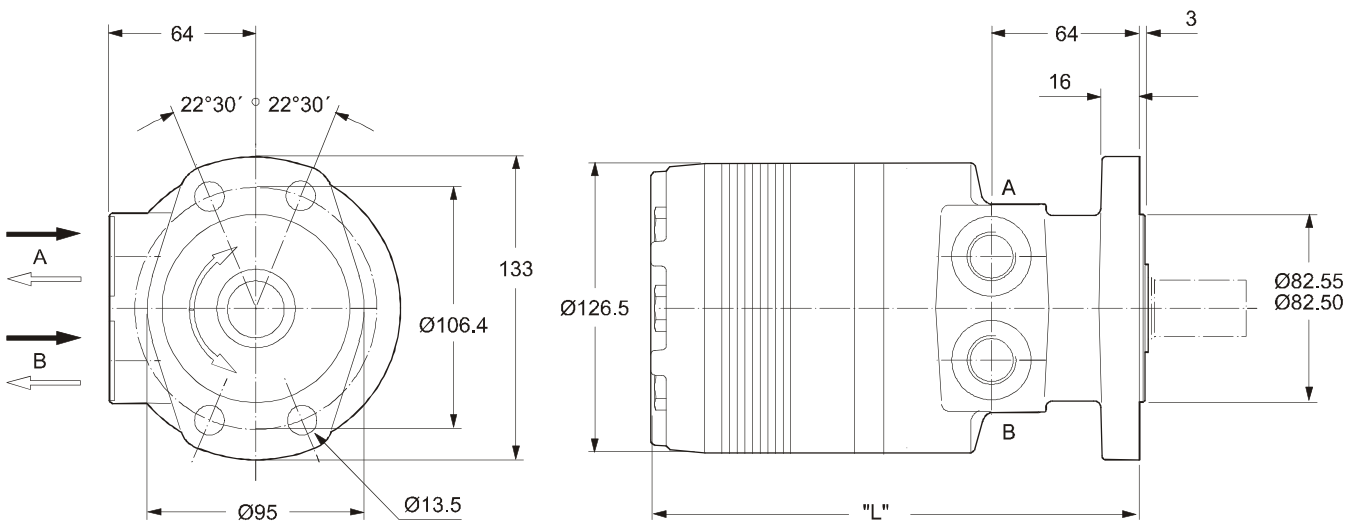

Gewicht / Weight		TG140	TG170	TG195	TG240	TG280	TG335	TG405	TG475	TG530	TG625	TG785	TG960
Poids / Peso	kg	14,2	14,5	14,7	15,1	15,5	15,9	16,5	17,2	17,9	18,6	20,2	22,0
Code E	"L" mm	191	194	197	202	207	213	220	229	235	245	264	283
Code M	"L" mm	196	199	202	208	212	218	225	234	240	250	269	288

Code H

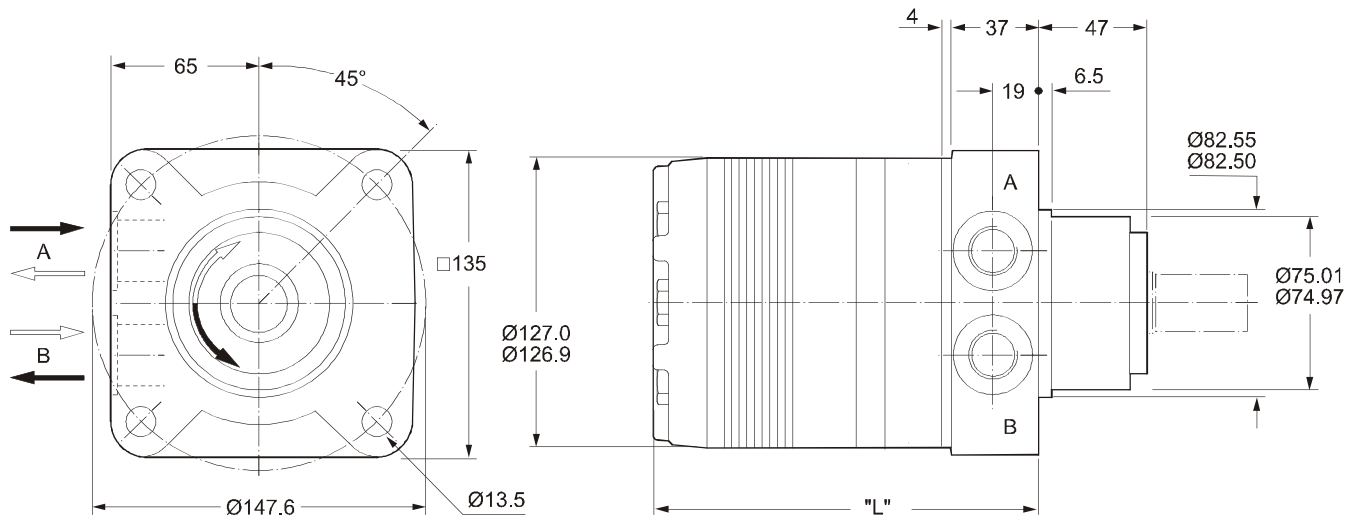

Code V

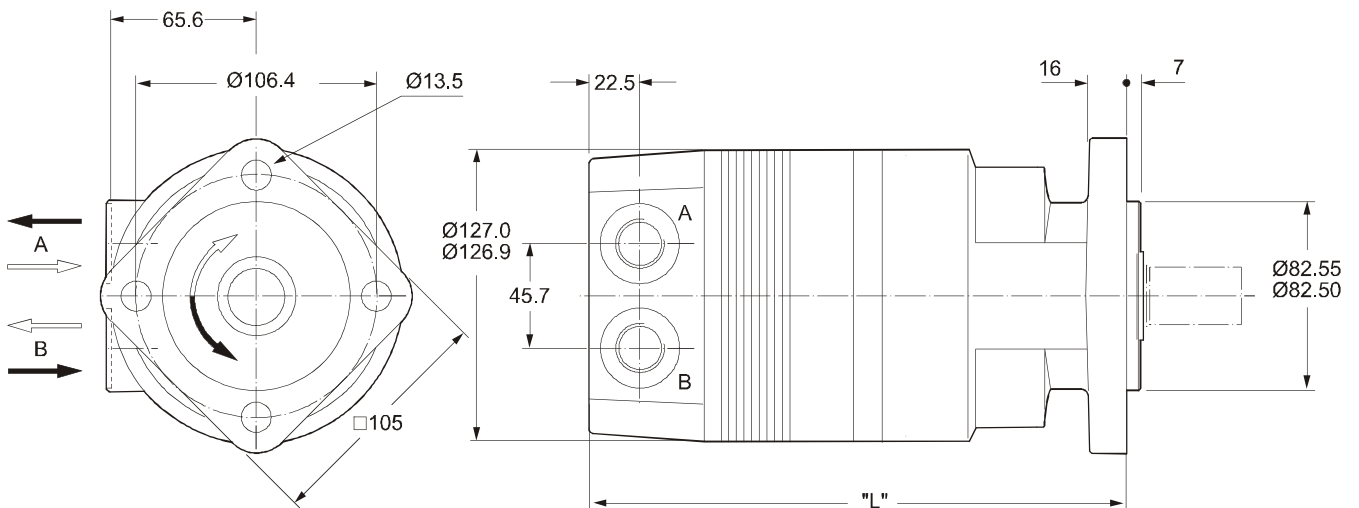

Gewicht / Weight		TG140	TG170	TG195	TG240	TG280	TG335	TG405	TG475	TG530	TG625	TG785	TG960
Poids / Peso	kg	16.1	16.3	16.6	17.0	17.4	17.8	18.4	19.0	19.8	20.5	22.0	23.7
Code H	"L" mm	150	154	157	162	166	173	180	188	195	204	223	242
Code V	"L" mm	217	220	224	228	233	238	246	255	262	272	290	309

Code W

G1/2 x 15

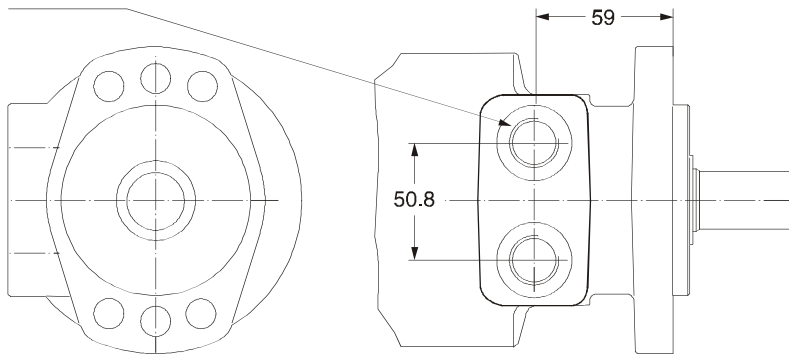

Code: N

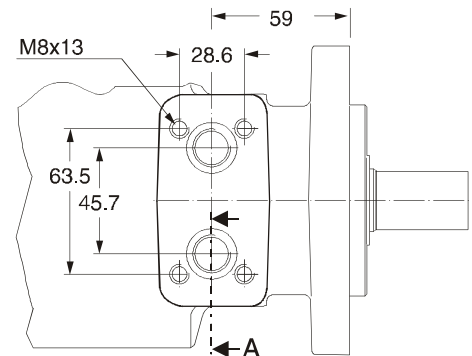

Code W

G1/2 x 15

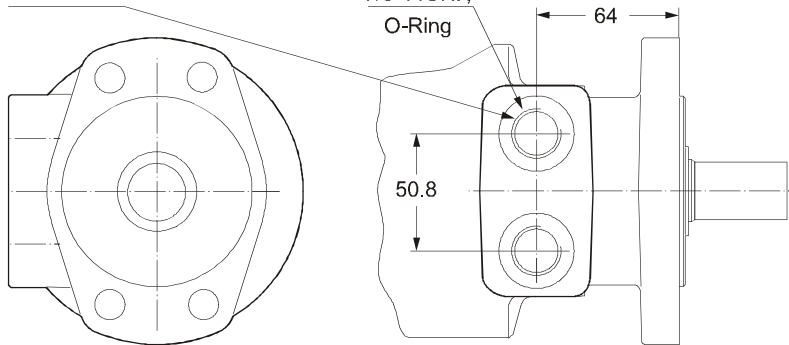

Code V

7/8-14UNF,
O-Ring

Code N

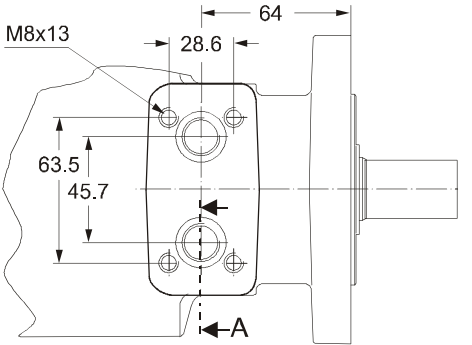

Code W

G1/2 x 15

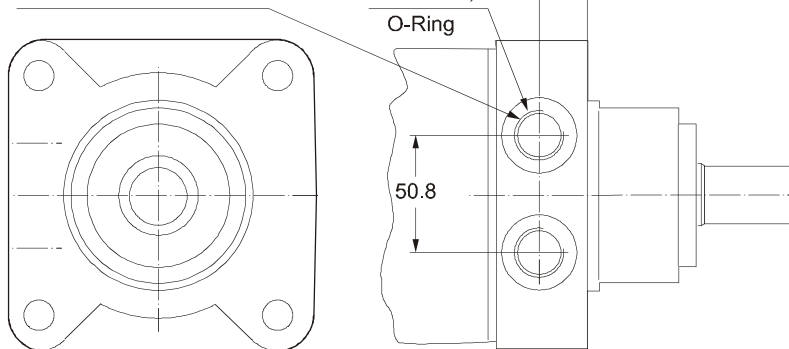

Code V

7/8-14UNF,
O-Ring

Code K

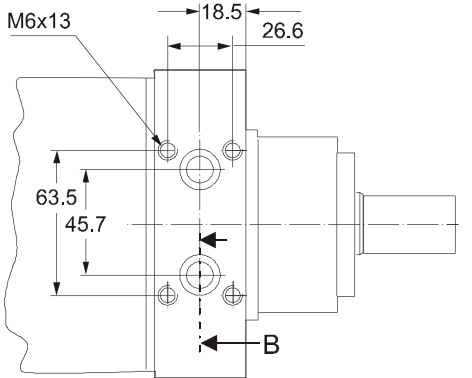

Section A

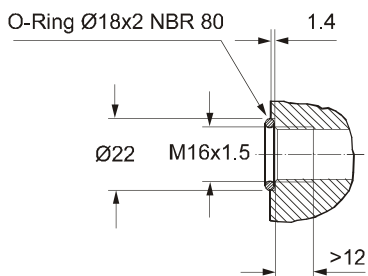

Section B

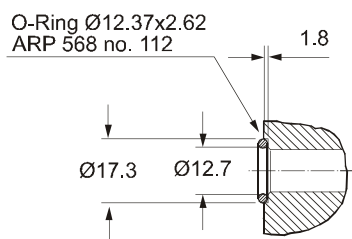

Zum Motor mit Universalanschluß werden 2 O-Ringe geliefert.

Motor with manifold mount is supplied with 2 O-rings.

Deux joints toriques sont livrés avec les moteurs au plan de raccordement universel.

Il blocchetto connessioni è corredato da 2 OR.

Code B 7/8-14UNF

Code X G 1/2

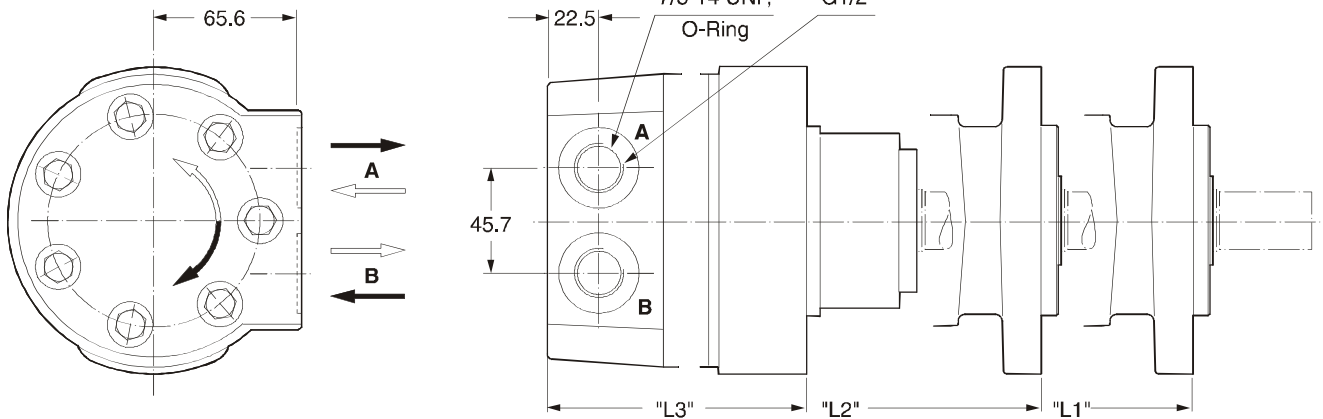

Code L

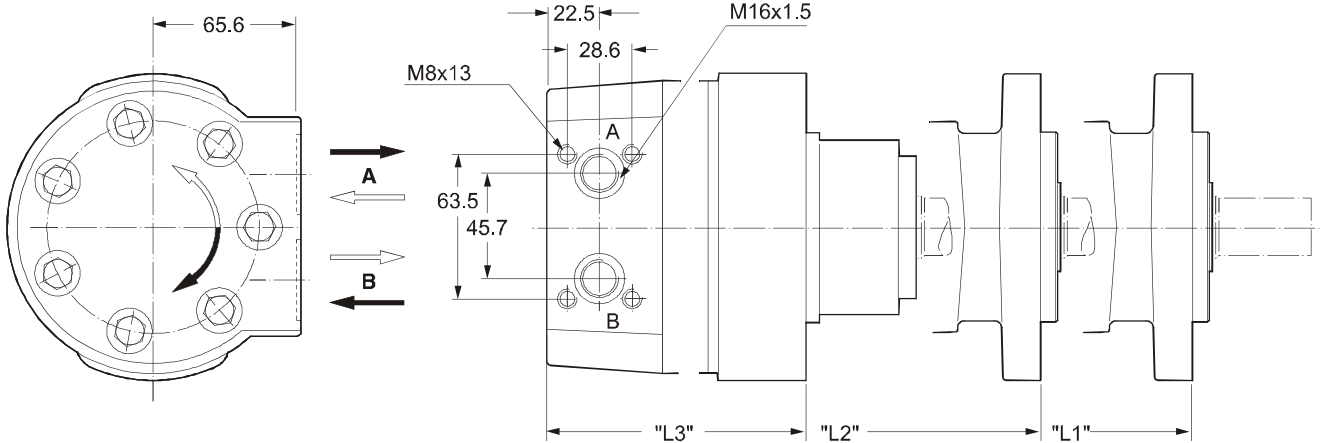

Code A 7/8-14UNF

Code Y G 1/2

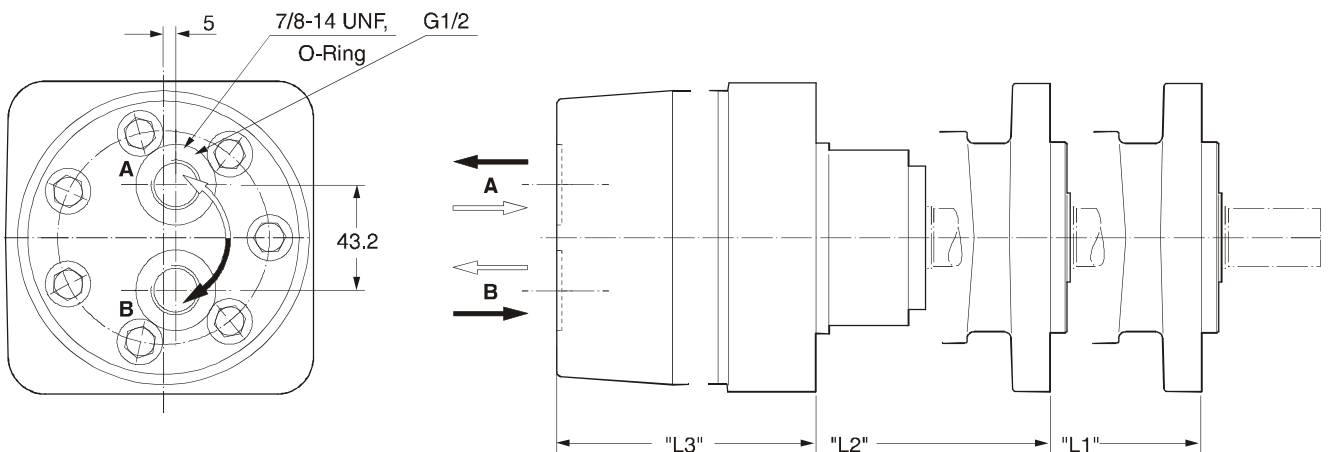

Gewicht / Weight		TG140	TG170	TG195	TG240	TG280	TG335	TG405	TG475	TG530	TG625	TG785	TG960
Poids / Peso	kg	16.1	16.3	16.6	17.0	17.4	17.8	18.4	19.0	19.8	20.5	22.0	23.7
Code	"L1" mm	216	219	222	227	232	238	245	254	260	270	289	308
	B, X, L, "L2" mm	221	224	227	232	237	243	250	259	265	275	294	313
	A, Y "L3" mm	175	179	182	187	191	198	205	213	220	229	247	267

Torqmotoren 3213.PM6.5 RH

Code 44

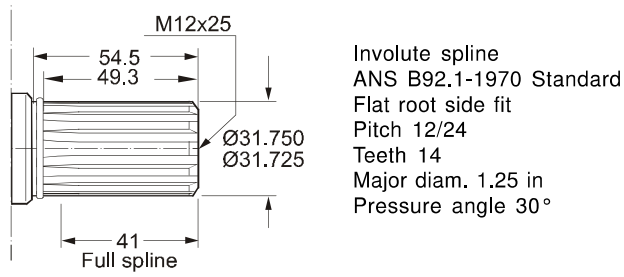

Code 45

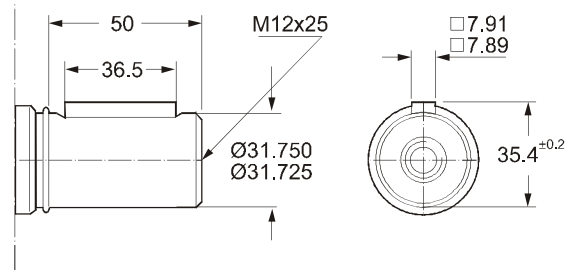

Code 08

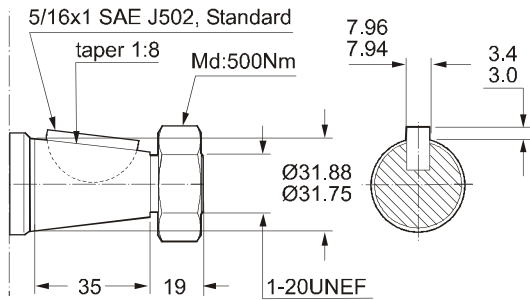

Code 46

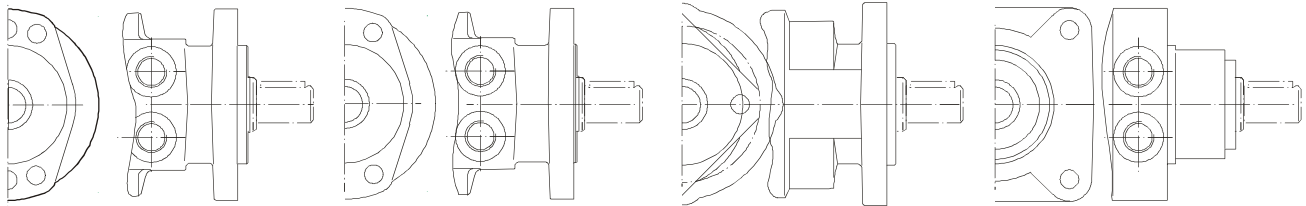
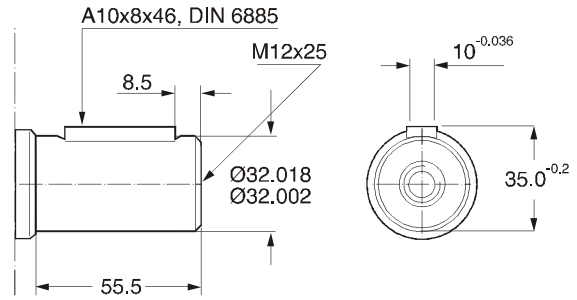

Code 44

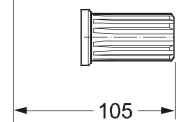
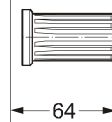
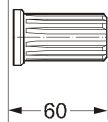
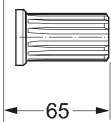

Code 45

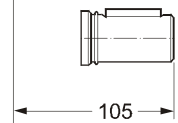
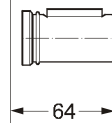
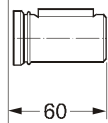
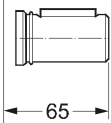

Code 08

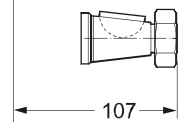
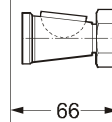
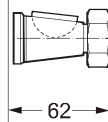
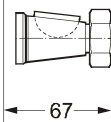

Code 46

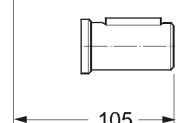
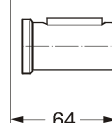
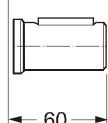
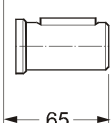

TG 140

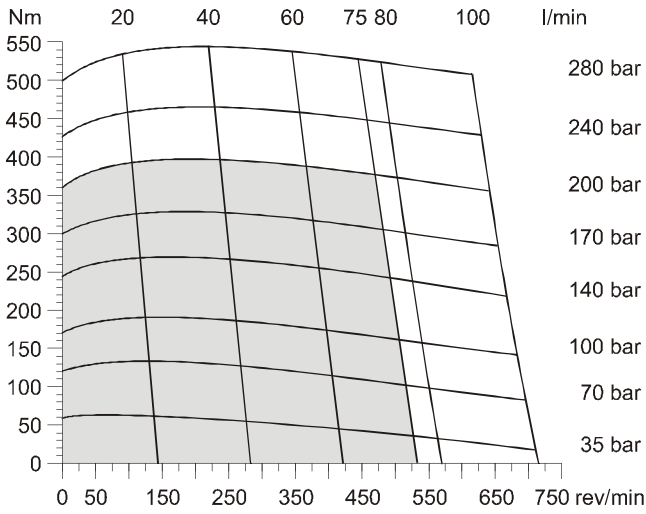

TG 170

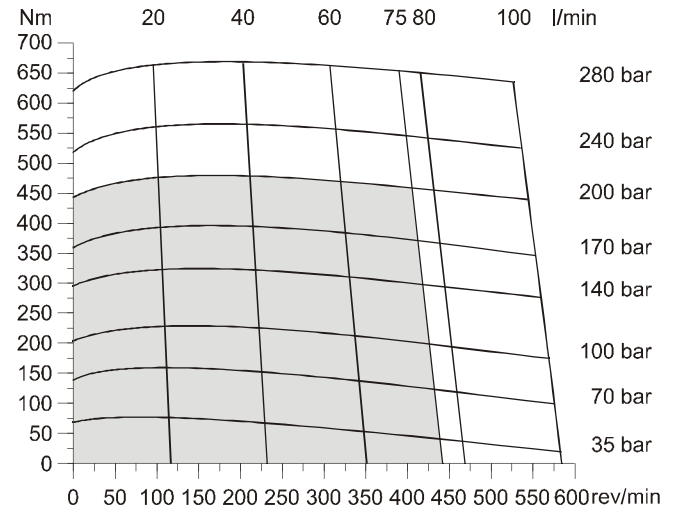

TG 195

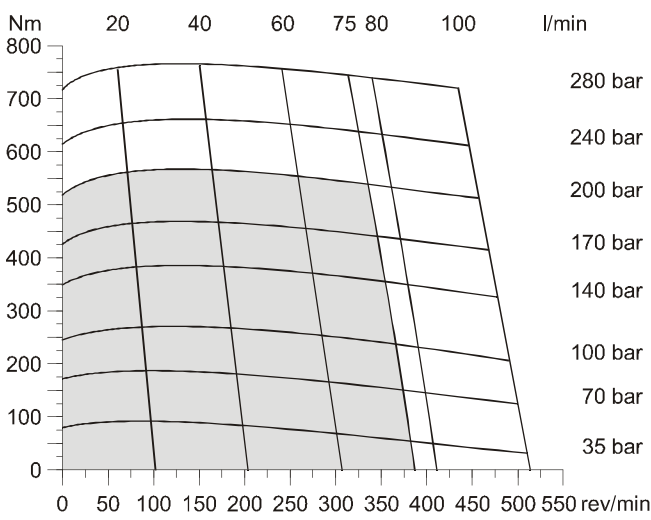

TG 240

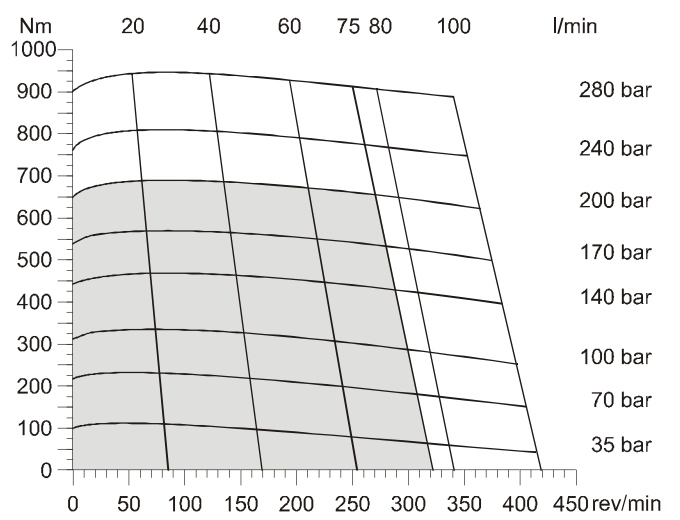

TG 280

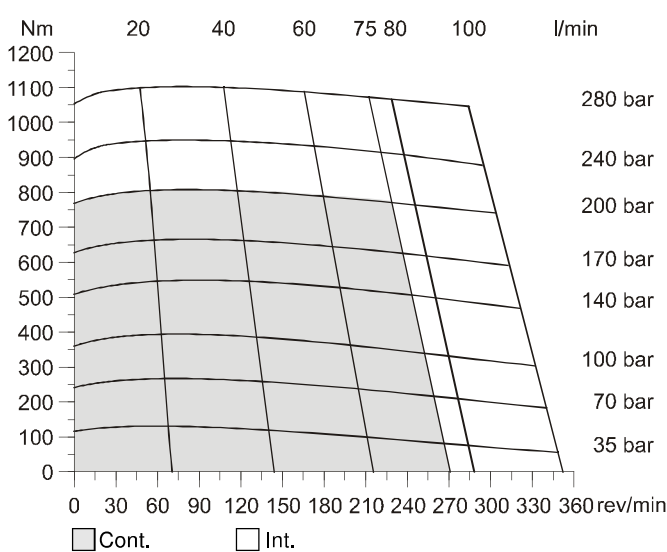

TG 335

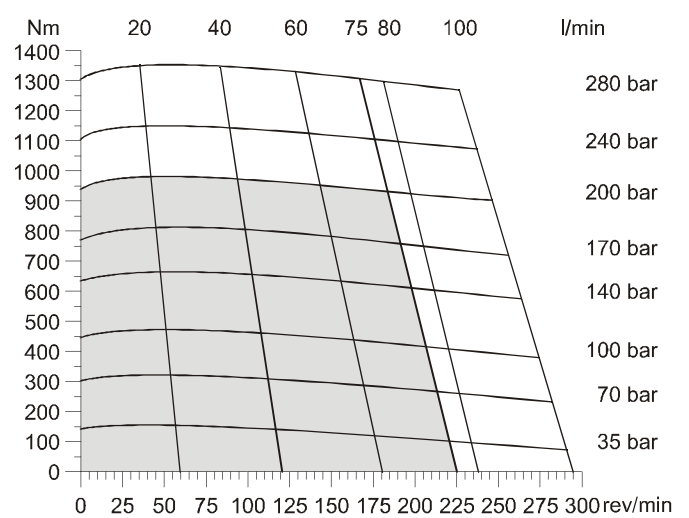

int. =
 Intermittierende Werte maximal: 10% von jeder Betriebsminute.
 Intermittent operation rating applies to 10% of every minute.
 Fonctionnement interm.: 10% max. de chaque minute d'utilisation.
 Servizio intermittente: 10% max di ogni minuto di utilizzazione.

TG 405

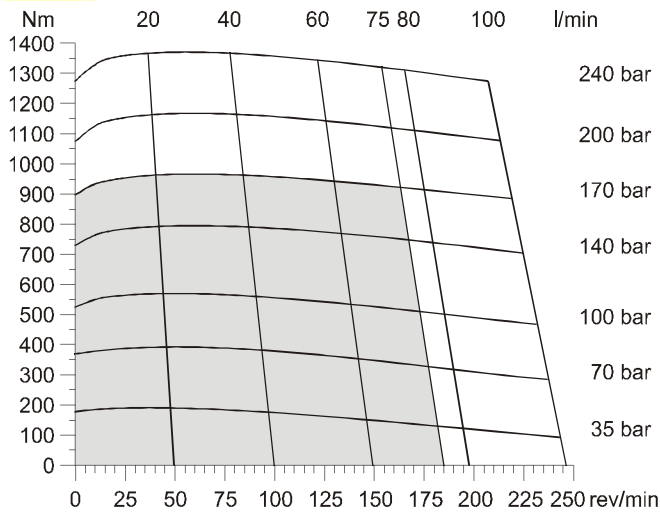

TG 475

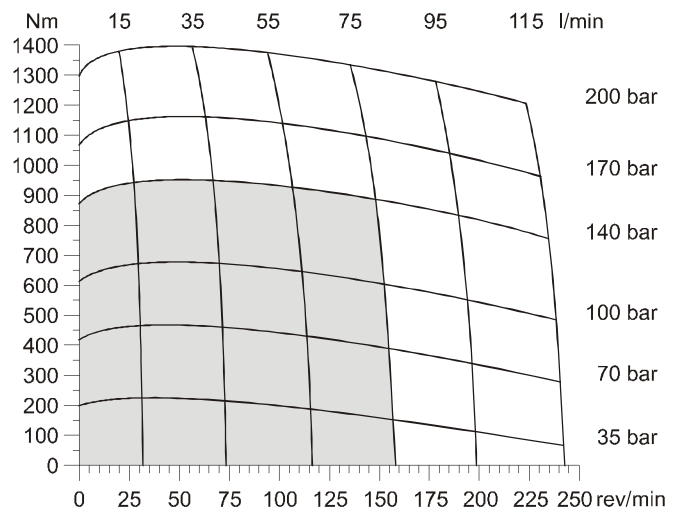

TG 530

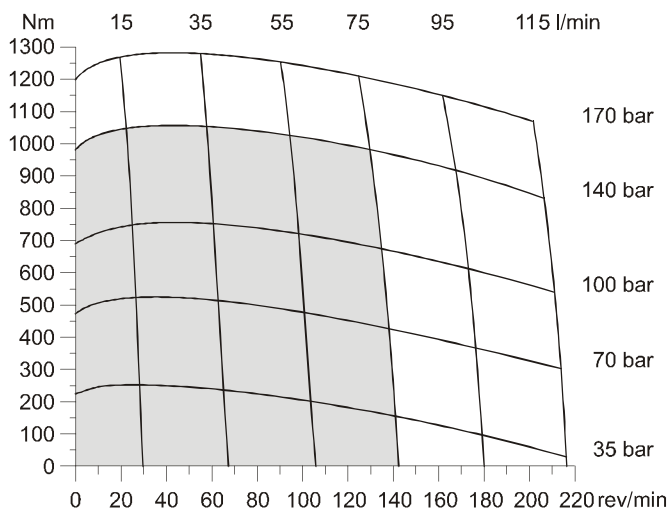

TG 625

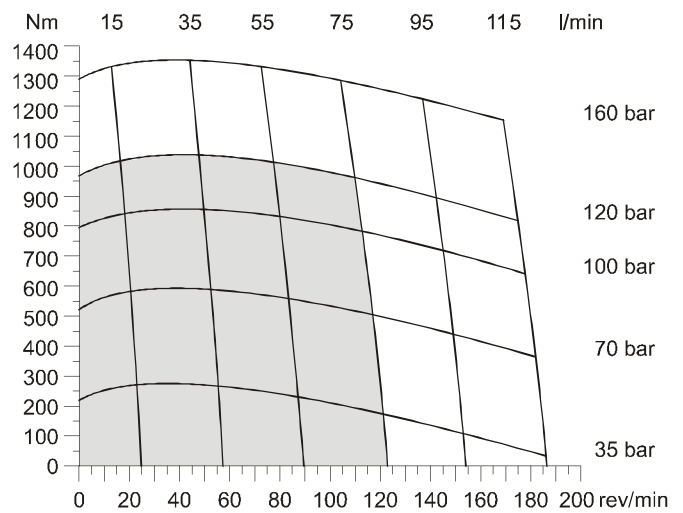

TG 785

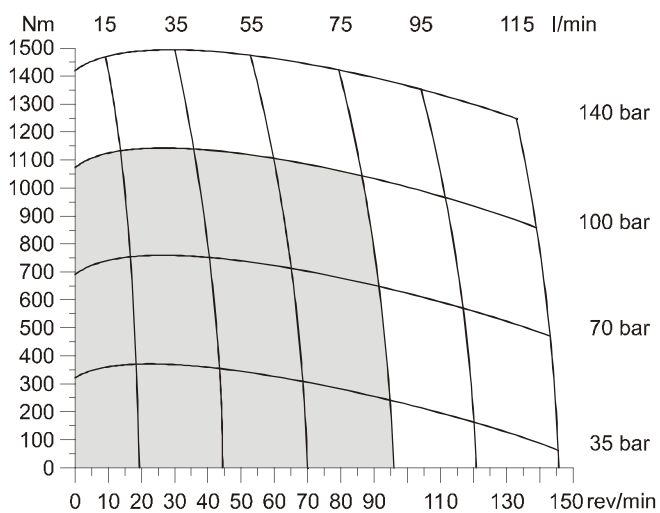

TG 960

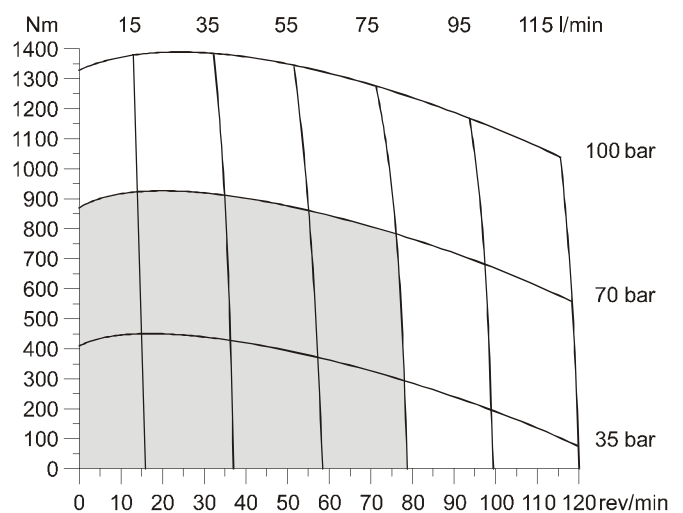

■ Cont. □ Int.

int. =
 Intermittierende Werte maximal: 10% von jeder Betriebsminute.
 Intermittent operation rating applies to 10% of every minute.
 Fonctionnement interm.: 10% max. de chaque minute d'utilisation.
 Servizio intermittente: 10% max di ogni minuto di utilizzazione.

Code E

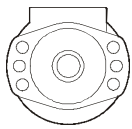

$$L_h = \frac{\left(\frac{670000}{F_R \cdot \left(1.10 + \frac{L}{88\text{mm}} \right)} \right)^{3.3}}{n}$$

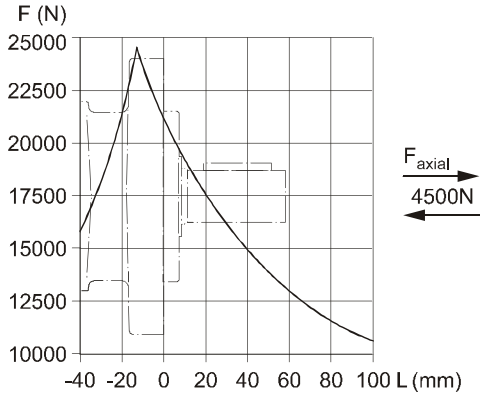

Code M

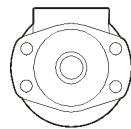

$$L_h = \frac{\left(\frac{670000}{F_R \cdot \left(1.16 + \frac{L}{88\text{mm}} \right)} \right)^{3.3}}{n}$$

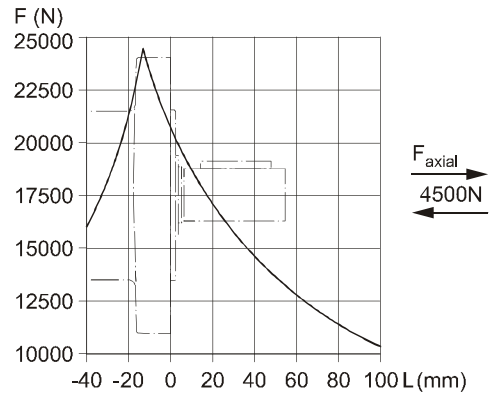

Code H

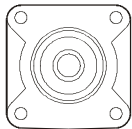

$$L_h = \frac{\left(\frac{670000}{F_R \cdot \left(0.56 + \frac{L}{88\text{mm}} \right)} \right)^{3.3}}{n}$$

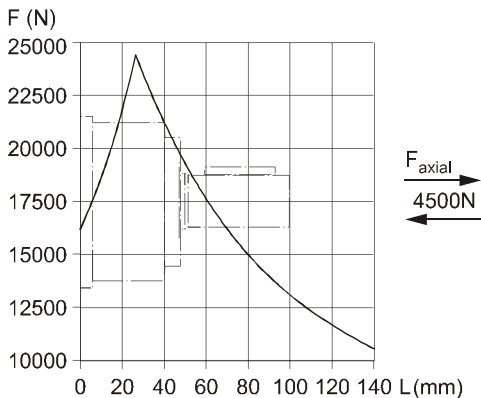

Code V

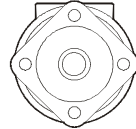

$$L_h = \frac{\left(\frac{670000}{F_R \cdot \left(1.11 + \frac{L}{88\text{mm}} \right)} \right)^{3.3}}{n}$$

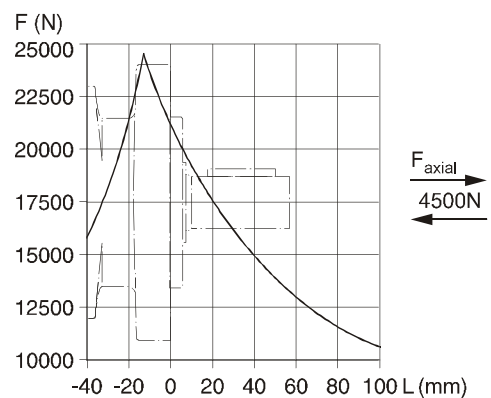

Die Lebensdauer der Radiallager (L_h in Stunden) läßt sich nach folgender Formel berechnen. Die Größe F_R ist durch die mechanische Festigkeit der Abtriebswelle begrenzt (siehe Diagramm). Das Maß "L" ist das Längenmaß vom Gehäuseflansch bis zum Angriffspunkt der Radialkraft F_R .

La durée de vie des roulements radiaux (L_h en heures) peut être calculée par les formules suivantes. La grandeur F_R est limitée par les résistances mécaniques de l'arbre de sortie (voir diagramme). La cote "L" est la longueur entre la bride du carter jusqu'au point d'appui de l'effort radial F_R .

Life time (L_h in hours) of the radial bearings can be calculated with the following formula. The value F_R is limited by the mechanical strength of the shaft (see diagram). The measurement "L" is the length from the housing flange up to the point of impact of the radial force F_R .

La durata dei cuscinetti (L_h in ore) può essere calcolata con la seguente formula. Il valore F_R è limitato dalla resistenza meccanica dell'albero (vedi diagramma). La quota "L" è la distanza tra la flangia del corpo ed il punto di applicazione della forza radiale F_R .

Vorstehende Formeln gelten für eine B10-Lebensdauer.
 The preceding formulas are valid for a B10 duration of life.
 Les formules précédentes sont valables pour une durée de vie B10.
 Le formule precedenti sono valide per una durata della vita B10.

L_h = h
 L = mm
 F_R = F (N)
 n = rev/min

TG	[] [] [] []	[]	[]	[] []	[]	A A A B
Serie Series Série Serie	Schluckvolumen Displacement Cylindrée Cilindrata	Gehäuse Housing Carter Corpo motore	Anschluß Ports Plan de raccordement Connessioni	Welle Shaft Arbre Albero	Drehrichtung Direction of rotation Direction de rotation Direzione di rotazione	Option

Code	cm ³ /rev
0140	140
0170	169
0195	195
0240	237
0280	280
0335	337
0405	405
0475	476
0530	529
0625	624
0785	786
0960	958

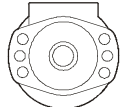
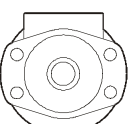
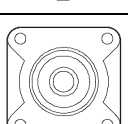
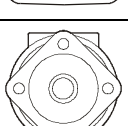

Code	Housing
E	
M	
H	
V ¹⁾	

Code	Front port
W	G 1/2
V	7/8-14 UNF O-Ring
N ²⁾	Universal M8x13
K ³⁾	Universal M6x13

²⁾ Nicht verfügbar für Gehäuse "H"
 Not possible for housing "H"
 Pas disponible pour carter "H"
 Non Disponibile con il corpo codice "H"

³⁾ Nicht verfügbar für Gehäuse "M, E, V"
 Not possible for housing "M, E, V"
 Pas disponible pour carter "M, E, V"
 Non disponibile con il corpo codice "M, E, V"

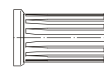
Code	Rear port
Y	G 1/2 Axial
A	7/8-14 UNF Axial
X	G 1/2 Radial
B	7/8-14 UNF Radial
L	Universal Radial M8x13

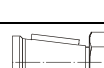
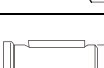
Code	Shaft
44	 Pitch 12/24
45	 31.75
08	
46	 32

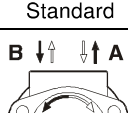
Code	Front port
0	 Standard
1	

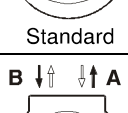
Code	Rear port
0	 Standard
1	

For further options different to standard 'AAAB' see page 57.