

Dual P.O. Check Valve Cartridge, SAE 08 / NG 5

$Q_{\max} = 5 \text{ gpm (19 l/min)}$, $p_{\max} = 3600 \text{ psi (250 bar)}$

Pilot operated

Series PDCV-08...



- A low friction pilot piston is standard
- Compact construction for cavity types: C0840 and AN/C0840 – 3/4-16 UNF
- Separate springs assure fast return to neutral position
- Reliable and high positive re-seat duration
- All exposed parts with zinc-nickel plating
- Can be fitted in a line-mounting body
- Replaces POCD-08...

1 Description

The PDCV-08... series dual pilot operated check valve cartridges are size SAE 08 / NG 5, high performance screw-in valves with a 3/4-16 UNF mounting thread. This unit is a cartridge type, high strength steel guided poppet for realizable low leakage performance, dual hydraulic pilot operated check valve, for use as a blocking or load holding device at high pressure applications. This valve allows free flow from port 2 to port 1 and from port 3 to port 4 and it blocks flow from port 1 to port 2 and from port 4 to port 3. Flow is allowed from port 1 to port 2 when pilot pressure is

sensed at port 3 or flow is allowed from port 4 to port 3 when pilot pressure is sensed at port 2. In order to pilot the valve opens, the pressure at port 2 or port 3 needs to exceed one-third of the load pressure from port 1 or port 4. All external parts of the cartridge are zinc-nickel plated to DIN 50 979 and are thus suitable for use in the harshest operating environments. If you intend to manufacture your own cavities or are designing a line-mounting installation, please refer to the section "Related data sheets".

2 Symbol

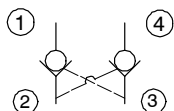

PDCV-08-...-C...

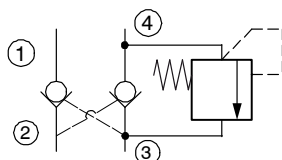

PDCV-08-...-3...

3 Technical data

General characteristics	Description, value, unit
Designation	dual p.o. check valve cartridges
Design	pilot operated
Mounting method	screw-in cartridge 3/4-16 UNF
Size	SAE 08 / NG 5 for cavity type C0840 and AN/C0840
Weight	0.26 lbs (0.12 kg)
Mounting attitude	unrestricted
Ambient temperature range	-40 °F...+250 °F (-40 °C...+120 °C)
Optional internal thermal relief valve	from port 4 to port 3 3000 psi (210 bar), not adjustable

Hydraulic characteristics	Description, value, unit
Maximum operating pressure	3600 psi (250 bar)
Maximum flow rate	5 gpm (19 l/min)
Pilot Ratio	3.0 to 1
Leakage flow rate	5 drops/min @ 3500 psi (5 drops/min @ 240 bar)
Flow direction	see symbol
Hydraulic fluid	HL and HLP mineral oil to DIN 51 524; for other fluids, please contact BUCHER
Hydraulic fluid temperature range	-40 °F...+250 °F (-40 °C...+120 °C)
Viscosity range	15...380 mm ² /s (cSt), recommended 20...130 mm ² /s (cSt)
Minimum fluid cleanliness Cleanliness class to ISO 4406 : 1999	class 18/16/13

4 Performance graphs

measured with oil viscosity 33 mm²/s (cSt)

$\Delta p = f(Q)$ Pressure drop - Flow rate characteristic
"free flow 2 → 1"

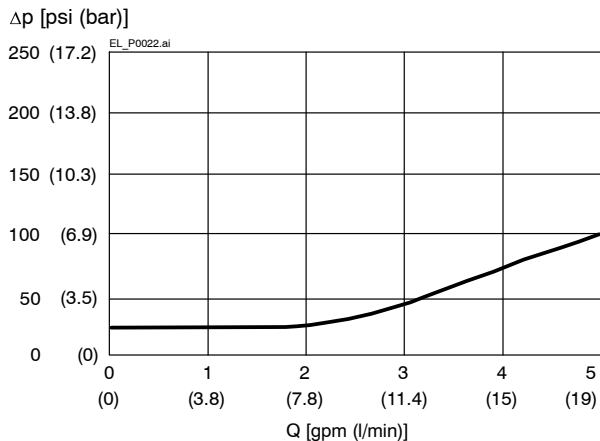

$\Delta p = f(Q)$ Pressure drop - Flow rate characteristic
"free flow 3 → 4"

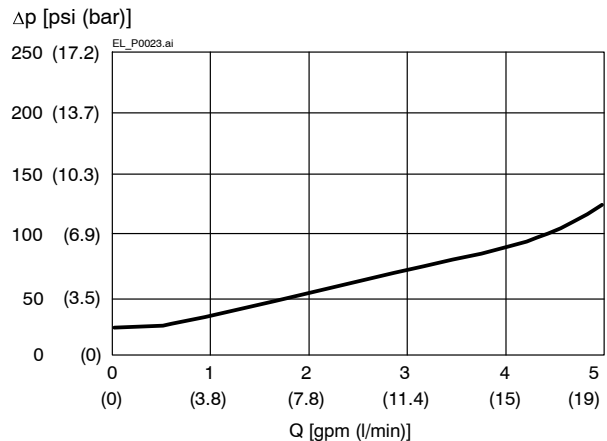

Attention:

When flow passes through the check valve and there is a large pressure difference, the poppet in the main stage can be damaged.

$Q = f(\Delta p; I)$ Flow rate adjustment characteristic
"pilot 3 flow 1 → 2"

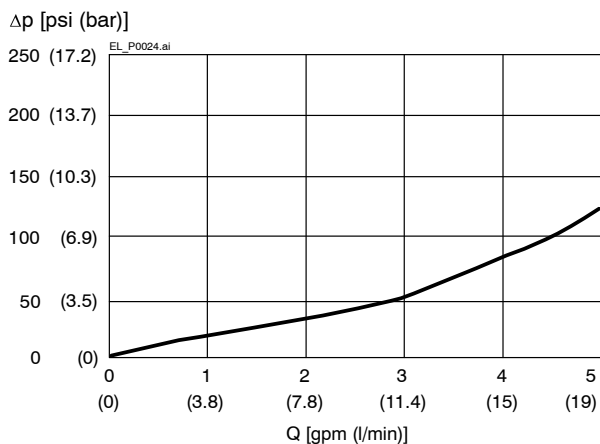

$Q = f(I; \Delta p)$ Flow rate adjustment characteristic
"pilot 2 flow 4 → 3"

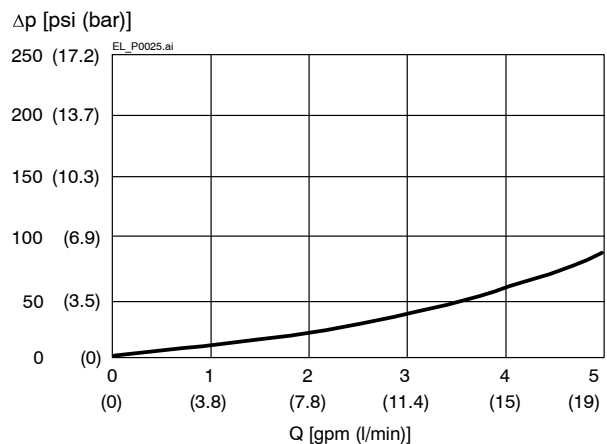

5 Dimensions & sectional view

Dimensions in inches (millimeters)

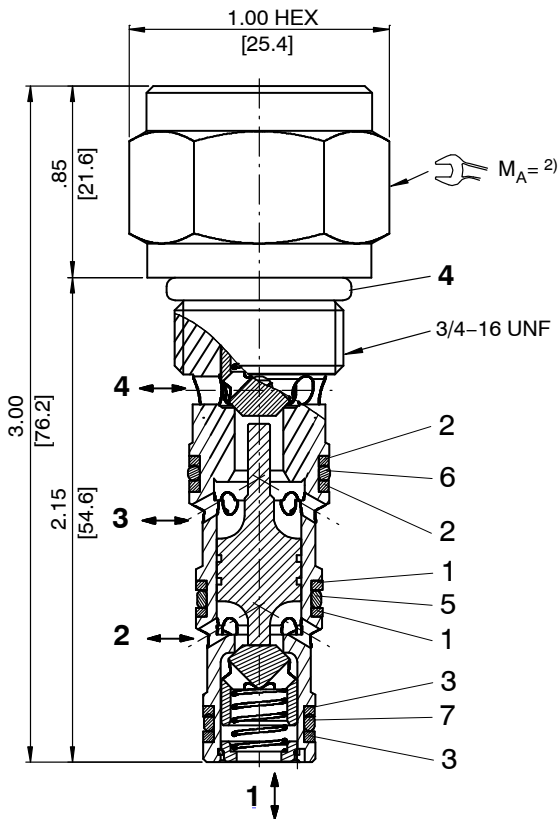

Tightening torque $M_A^{2)} \pm 10\%$

Cavity type	C0840, AN/C0840
When fitted in steel	37 ft-lbs (50 [Nm])
When fitted in aluminium	27 ft-lbs (37 [Nm])

6 Installation information



Important:

When fitting the cartridges, use the specified tightening torque. No adjustments are necessary, since the cartridges are set in the factory.



ATTENTION!

Only qualified personnel with mechanical skills may carry out any maintenance work. Generally, the only work that should ever be undertaken is to check, and possibly replace, the seals. When changing seals, oil or grease the new seals thoroughly before fitting them.

Seal kit NBR no. SKN-0828 ¹⁾

Item	Qty.	Description	
4	1	O-ring no. 908 \varnothing 0.644 x 0.087 N90	Inch
6	2	O-ring \varnothing 13.00 x 1.50 FKM	mm
5	2	O-ring \varnothing 11.00 x 1.50 FKM	mm
7	2	O-ring \varnothing 9.50 x 1.50 FKM	mm
2	2	Backup ring \varnothing 13.00 x 1.50 x 1.00 FI0751	mm
1	2	Backup ring \varnothing 11.30 x 1.50 x 1.00 FI0751	mm
3	2	Backup ring \varnothing 9.50 x 1.50 x 1.00 FI0751	mm



IMPORTANT!

¹⁾ Seal kit with FKM (Viton) seals, no. SKV-0828

7 Ordering code

PDCV - 08 - N - C - O

PDCV = pilot operated dual check valve

08 = size SAE 08 / NG 5

N = NBR (Nitrile) seals (standard)

V = FKM (Viton) seals
(special seals - please consult BUCHER)

C = no thermal relief

3 = 3000 psi (210 bar) internal thermal relief from port 4 to port 3, not adjustable

0 = cartridge only

02BA = line-mounting body G1/4 BSPP aluminum

02BS = line-mounting body G1/4 BSPP steel

06TA = line-mounting body SAE-#6 aluminum

06TS = line-mounting body SAE-#6 steel

8 Related data sheets

Reference	(Old no.)	Description
520-P-000050		Form tools
520-P-000410		Cavity type C0840
...		Cavity type AN/C0840
520-P-000411		Line-mounting body, 08 Series – 4-way

info.el@bucherhydraulics.com

www.bucherhydraulics.com/commoncavity

© 2018 by Bucher Hydraulics, Inc., 2545 Northwest Parkway, Elgin, Illinois 60124, USA

All rights reserved.

Data is provided for the purpose of product description only, and must not be construed as warranted characteristics in the legal sense. The information does not relieve users from the duty of conducting their own evaluations and tests. Because the products are subject to continual improvement, we reserve the right to amend the product specifications contained in this catalogue.

Classification: 430.315.345.305.305