



**Torqmotor™**  
**Series TF/TG/TH/TK**  
*max. 49 kW*

*Catalogue HY11-3213/EU*  
*Ed. 06 / 2003*



- **Langsamlaufender Gerotor-Motor**
  - **Spezielle Orbital-Steuerung**  
Geringe interne Leckage  
Hoher volumetrischer Wirkungsgrad
  - **Rollen im Rotorsatz**  
Reduzierte Reibung  
Lange Lebensdauer
  - **Patentierte Hochdruckwellendichtung**  
Keine Leckölleitung  
Keine Rückschlagventile
  - **Vielzahl von Varianten**  
Großer Einsatzbereich
- 
- **Moteur lent système Gerotor**
  - **Une distribution orbitale particulière assure**  
fuites internes minimales  
rendements volumétriques élevés
  - **Le rotor à rouleaux**  
réduit les frottements  
augmente la durée de vie
  - **Par l'utilisation de joints d'arbre haute pression brevetés**  
pas de conduite de drainage  
pas de clapets anti-retour
  - **Grâce à de nombreuses variantes**  
larges domaines d'application
- 
- **Low Speed Gerotor Motor**
  - **Zero leak commutation valve**  
For greater, more consistent volumetric efficiency
  - **Roller vane rotor set**  
Reduces friction and internal leakage  
Maintaining efficiency throughout the life of the motor
  - **A patented high-pressure shaft seal**  
No check valves needed  
No extra plumbing
  - **Wide choice of displacement range, flange and shaft options**  
Greater efficiency in systems design to suit your application
- 
- **Motore orbitale a bassa velocità**
  - **Una particolare distribuzione orbitale assicura**  
trafilamento ridotto  
elevato rendimento volumetrico
  - **Con lo statore a rullini**  
si riduce l'attrito interno  
si mantiene nel tempo l'efficieza del motore
  - **Una guarnizione di tenuta ad alta pressione brevettata elimina la necessità**  
di una linea di drenaggio esterna  
e di valvole di non ritorno
  - **Un'ampia gamma di cilindrata, flange ed alberi**  
consentono scelte adeguate ad ogni esigenza costruttiva

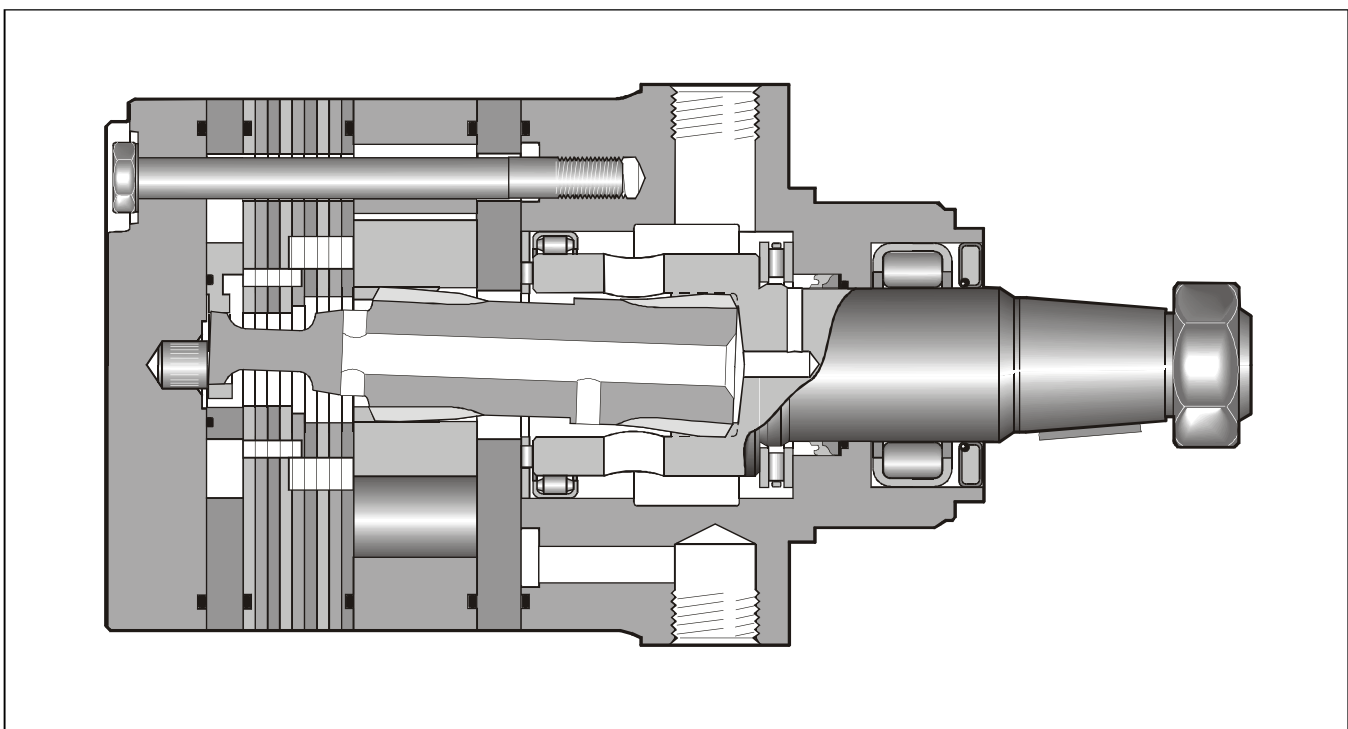

Torqmotoren 3213.PM6.5 RH

Drehzahl Speed Vitesse de rotation Velocità di rotazione	5...710 rev/min
Schluckstrom Oil flow Débit d'huile Portata	max. 115 l/min
Eingangsdruck Supply pressure Pression entrée Pressione in entrata	max. 300 bar
Drehmoment Torque Couple Coppia	max. 1490 Nm
Seitenlast Side load Charges latérales Carico radiale	max. 16.000 N

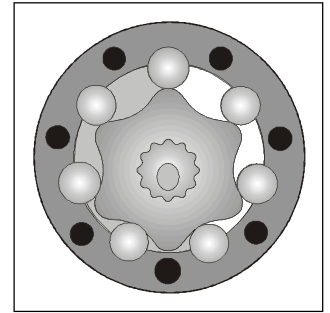
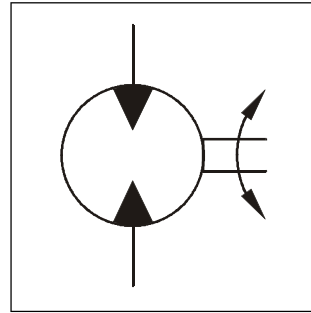

Motor series TG	cm <sup>3</sup> /U cm <sup>3</sup> /rev cm <sup>3</sup> /tr cm <sup>3</sup> /giro	cont / int U/min rev/min tr/min giri/min	cont / int l/min	cont / int bar	max bar	cont / int Nm	cont / int max. KW	cont / int Nm
<b>TG 140</b>	<b>140</b>	<b>530/710</b>	<b>75/100</b>	<b>200/280</b>	<b>300</b>	<b>400/ 545</b>	<b>33</b>	<b>320/436</b>
TG 170	169	440/575	75/100	200/280	300	485/ 670	33	388/536
TG 195	195	380/510	75/100	200/280	300	560/ 770	33	448/616
TG 240	237	320/420	75/100	200/280	300	685/ 945	32	548/756
TG 280	280	270/350	75/100	200/280	300	800/1100	31	640/880
TG 335	337	225/290	75/100	200/280	300	980/1350	30	784/1080
TG 405	405	185/245	75/100	170/240	300	960/1350	27	768/1080
TG 475	476	160/240	75/115	140/200	300	960/1400	28	768/1120
TG 530	529	140/215	75/115	140/170	300	1050/1280	23	840/1024
TG 625	624	120/185	75/115	120/160	300	1040/1360	20	832/1088
TG 785	786	95/145	75/115	100/140	300	1150/1490	17	920/1192
TG 960	958	78/119	75/115	70/100	300	925/1390	12	740/1112

int. =

Intermittierende Werte maximal: 10% von jeder Betriebsminute.

Intermittent operation rating applies to 10% of every minute.

Fonctionnement interm.: 10% max. de chaque minute d'utilisation.

Servizio intermittente: 10% max di ogni minuto di utilizzazione.

Torqmotoren 3213.PM6.5 RH

**Code E**

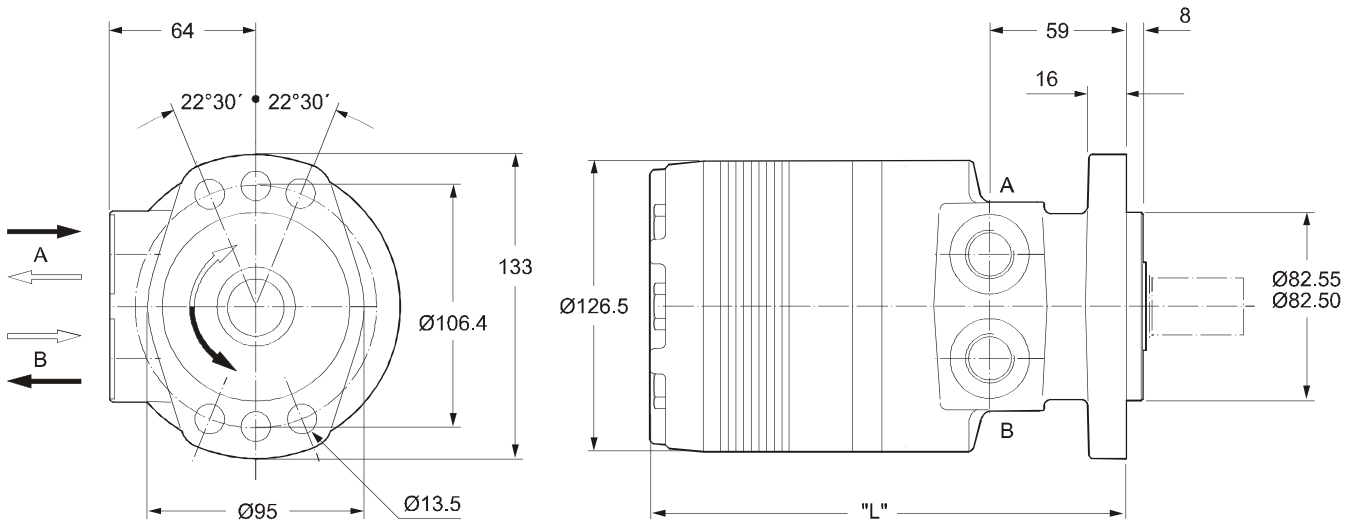

**Code M**

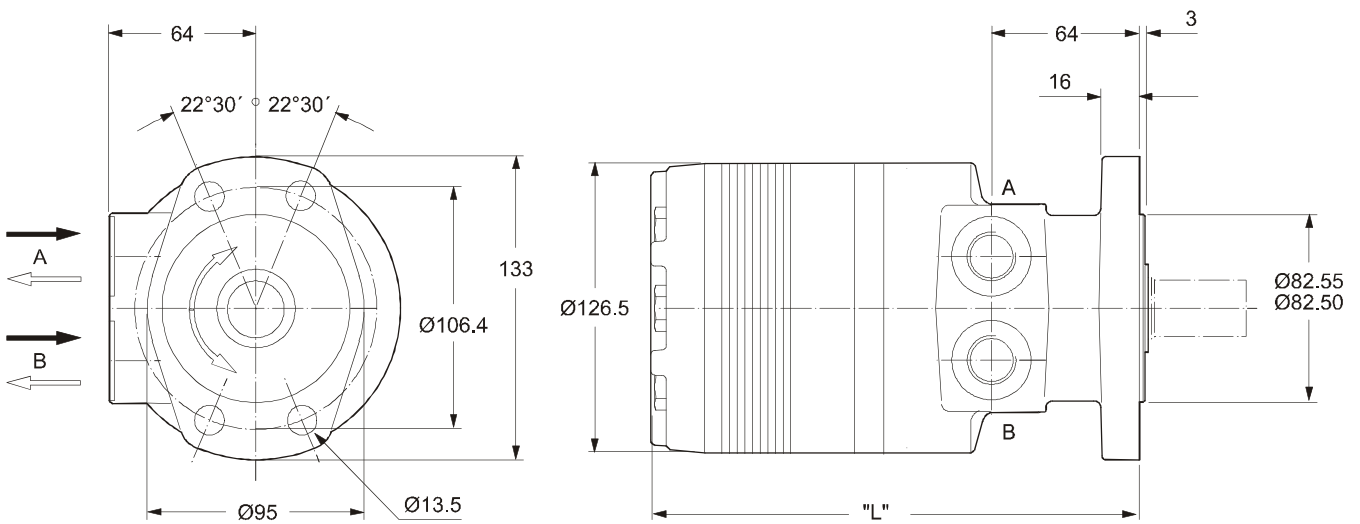

Gewicht / Weight		TG140	TG170	TG195	TG240	TG280	TG335	TG405	TG475	TG530	TG625	TG785	TG960
Poids / Peso	kg	14,2	14,5	14,7	15,1	15,5	15,9	16,5	17,2	17,9	18,6	20,2	22,0
Code E	"L" mm	191	194	197	202	207	213	220	229	235	245	264	283
Code M	"L" mm	196	199	202	208	212	218	225	234	240	250	269	288

**Code W**

G1/2 x 15

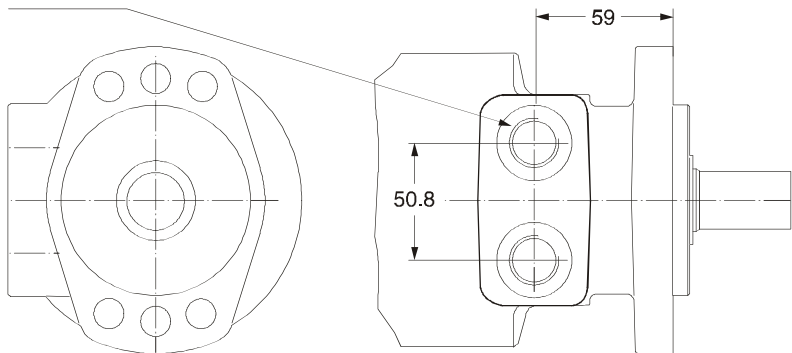

**Code: N**

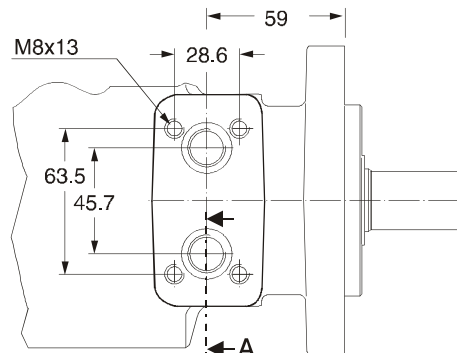

**Code W**

G1/2 x 15

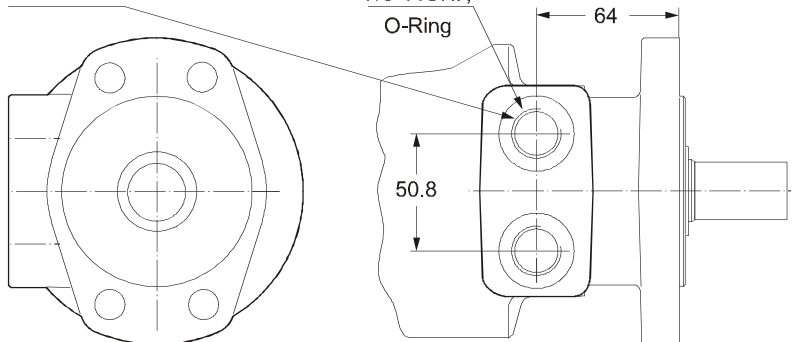

**Code V**

7/8-14UNF,  
O-Ring

**Code N**

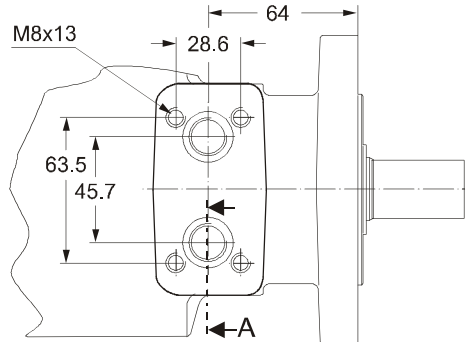

**Code W**

G1/2 x 15

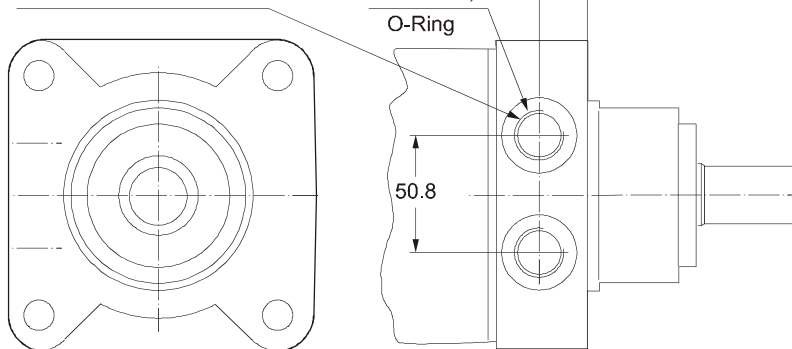

**Code V**

7/8-14UNF,  
O-Ring

**Code K**

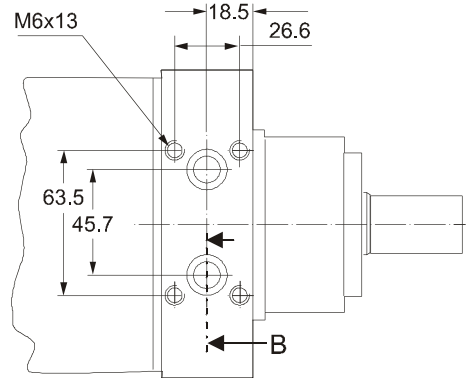

**Section A**

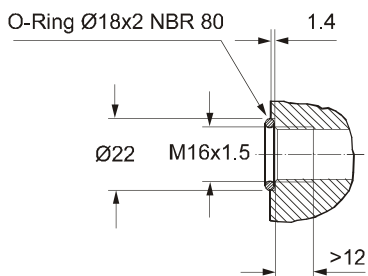

**Section B**

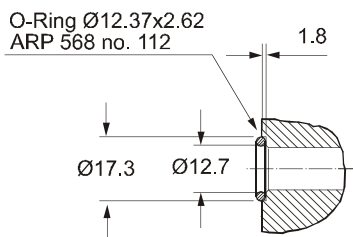

Zum Motor mit Universalanschluß werden 2 O-Ringe geliefert.

Motor with manifold mount is supplied with 2 O-rings.

Deux joints toriques sont livrés avec les moteurs au plan de raccordement universel.

Il blocchetto connessioni è corredato da 2 OR.

**Code 44**

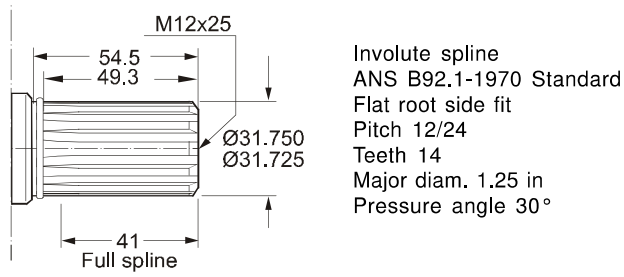

**Code 45**

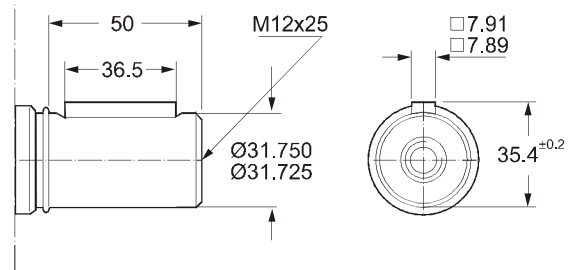

**Code 08**

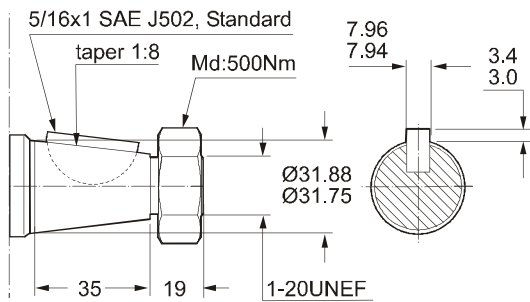

**Code 46**

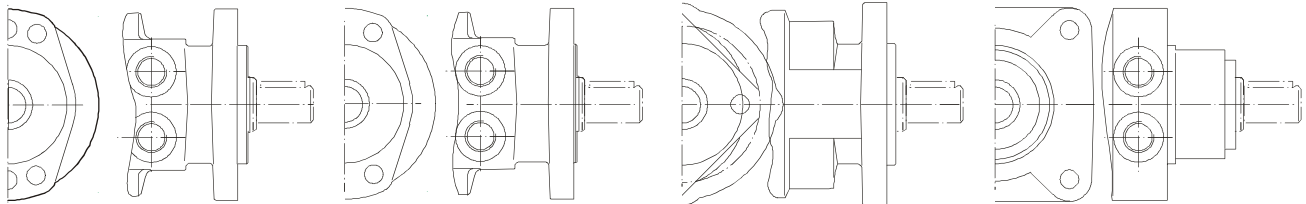
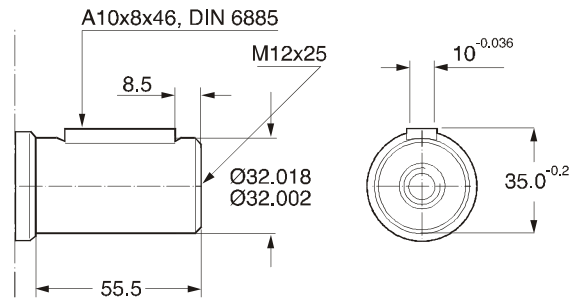

**Code 44**

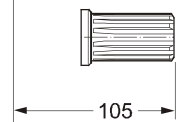
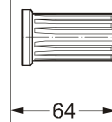
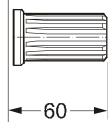
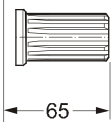

**Code 45**

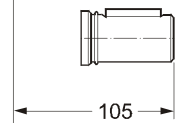
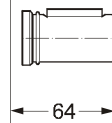
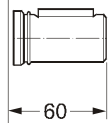
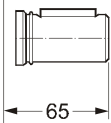

**Code 08**

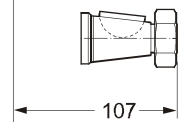
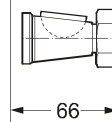
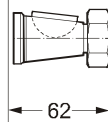
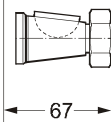

**Code 46**

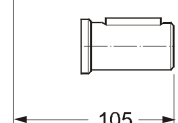
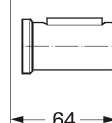
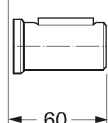
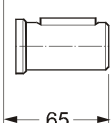

**Code E**

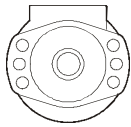

$$L_h = \frac{\left( \frac{670000}{F_R \cdot \left( 1.10 + \frac{L}{88\text{mm}} \right)} \right)^{3.3}}{n}$$

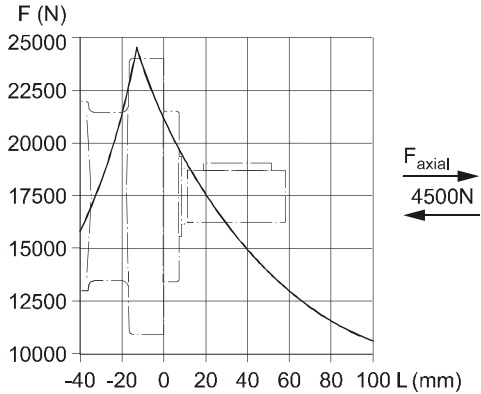

**Code M**

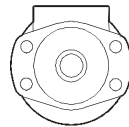

$$L_h = \frac{\left( \frac{670000}{F_R \cdot \left( 1.16 + \frac{L}{88\text{mm}} \right)} \right)^{3.3}}{n}$$

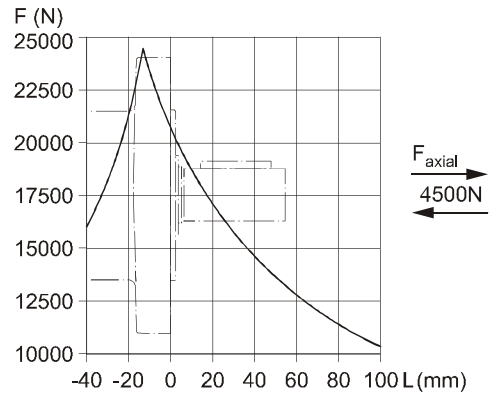

**Code H**

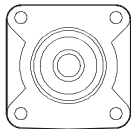

$$L_h = \frac{\left( \frac{670000}{F_R \cdot \left( 0.56 + \frac{L}{88\text{mm}} \right)} \right)^{3.3}}{n}$$

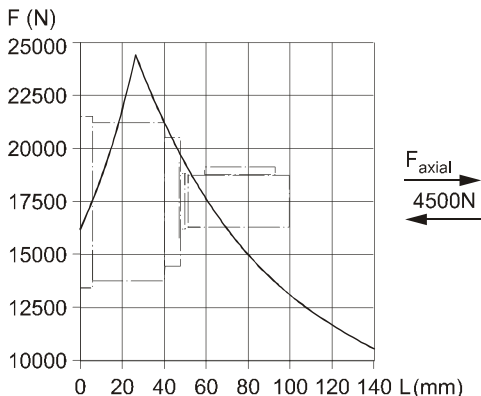

**Code V**

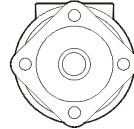

$$L_h = \frac{\left( \frac{670000}{F_R \cdot \left( 1.11 + \frac{L}{88\text{mm}} \right)} \right)^{3.3}}{n}$$

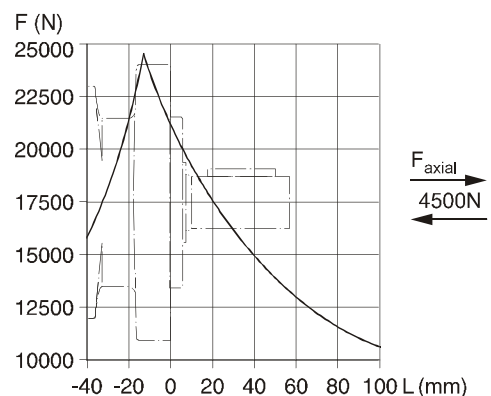

Die Lebensdauer der Radiallager ( $L_h$  in Stunden) läßt sich nach folgender Formel berechnen. Die Größe  $F_R$  ist durch die mechanische Festigkeit der Abtriebswelle begrenzt (siehe Diagramm). Das Maß "L" ist das Längenmaß vom Gehäuseflansch bis zum Angriffspunkt der Radialkraft  $F_R$ .

La durée de vie des roulements radiaux ( $L_h$  en heures) peut être calculée par les formules suivantes. La grandeur  $F_R$  est limitée par les résistances mécaniques de l'arbre de sortie (voir diagramme). La cote "L" est la longueur entre la bride du carter jusqu'au point d'appui de l'effort radial  $F_R$ .

Life time ( $L_h$  in hours) of the radial bearings can be calculated with the following formula. The value  $F_R$  is limited by the mechanical strength of the shaft (see diagram). The measurement "L" is the length from the housing flange up to the point of impact of the radial force  $F_R$ .

La durata dei cuscinetti ( $L_h$  in ore) può essere calcolata con la seguente formula. Il valore  $F_R$  è limitato dalla resistenza meccanica dell'albero (vedi diagramma). La quota "L" è la distanza tra la flangia del corpo ed il punto di applicazione della forza radiale  $F_R$ .

Vorstehende Formeln gelten für eine B10-Lebensdauer.  
 The preceding formulas are valid for a B10 duration of life.  
 Les formules précédentes sont valables pour une durée de vie B10.  
 Le formule precedenti sono valide per una durata della vita B10.

$L_h$  = h  
 $L$  = mm  
 $F_R$  = F (N)  
 $n$  = rev/min

**TG**    **140**    **EW**    **460**    **A A A B**

**Serie**    **Schluckvolumen**    **Gehäuse**    **Anschluß**    **Welle**    **Drehrichtung**    **Option**  
**Series**    **Displacement**    **Housing**    **Ports**    **Shaft**    **Direction of rotation**  
**Série**    **Cylindrée**    **Carter**    **Plan de raccordement**    **Arbre**    **Direction de rotation**  
**Serie**    **Cilindrata**    **Corpo motore**    **Connessioni**    **Albero**    **Direzione di rotazione**

For further options different to standard 'AAAB' see page 57.

Code	cm <sup>3</sup> /rev
<b>0140</b>	<b>140</b>
0170	169
0195	195
0240	237
0280	280
0335	337
0405	405
0475	476
0530	529
0625	624
0785	786
0960	958

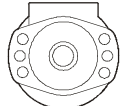
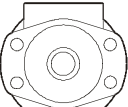
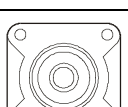
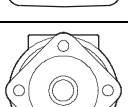
Code	Housing
<b>E</b>	
M	
H	
V <sup>1)</sup>	

Code	Front port
<b>W</b>	G 1/2
V	7/8-14 UNF O-Ring
N <sup>2)</sup>	Universal M8x13
K <sup>3)</sup>	Universal M6x13



<sup>2)</sup> Nicht verfügbar für Gehäuse "H"  
 Not possible for housing "H"  
 Pas disponible pour carter "H"  
 Non Disponibile con il corpo codice "H"  
<sup>3)</sup> Nicht verfügbar für Gehäuse "M, E, V"  
 Not possible for housing "M, E, V"  
 Pas disponible pour carter "M, E, V"  
 Non disponibile con il corpo codice "M, E, V"

Code	Rear port
Y	G 1/2 Axial
A	7/8-14 UNF Axial
X	G 1/2 Radial
B	7/8-14 UNF Radial
L	Universal Radial M8x13

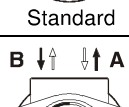
<sup>1)</sup> Nur verfügbar mit Endanschluß  
 Only possible with rear port  
 Possible seulement avec orifice arrière  
 Possible solo con connessioni posteriori

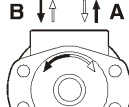
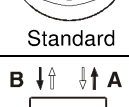
Code	Front port
<b>0</b>	 Standard
1	 Standard

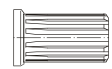
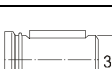
Code	Rear port
0	 Standard
1	 Standard

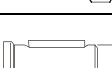
Code	Shaft
44	 Pitch 12/24
45	 31.75
08	
<b>46</b>	 32