

## Umschaltventile – Magnete

### – DFE10/6 –



Bestellnr.	Typ	Code
254-050-01155	DFE10/6A18ES-W202-12VDC	12A470021
254-050-01160	DFE10/6A18ES-W202-24VDC	12A470024
254-050-01165	DFE10/6A18ES-Y202-12VDC	12A470017
254-050-01170	DFE10/6A18ES-Y202-24VDC	12A470015
<b>254-050-01200</b>	<b>DFE10/6B18ES-W202-12VDC</b>	<b>12A480013</b>
254-050-01250	DFE10/6B18ES-W202-24VDC	12A480025
254-050-01300	DFE10/6B18ES-Y202-12VDC	12A480019



DFE

with solenoid control

Working conditions

This catalogue shows technical specifications and diagrams measured with mineral oil of 46 mm<sup>2</sup>/s - 46 cSt viscosity at 40°C temperature.

		DFE052	DFE10	DFE20
N. of available ways		2-3-6-8	3-6	3-6
Nominal flow rating	in steady conditions	60 l/min	90 l/min	140 l/min
Operating pressure (maximum)*	without drain	200 bar 2900 psi	200 bar 2900 psi	200 bar 2900 psi
	with drain	315 bar 4600 psi	315 bar 4600 psi	315 bar 4600 psi
Available nominal voltage	VDC	12-24 48-110	12-24-48	12-24
	VAC 50Hz (with C04 connector)	24-110-220	110-220	24-110-220
Potenza nominale	W	40	60	60
Internal leakage A(B)→T	Δp=100 bar 1450 psi with fluid and valve at 40°C	7 cm <sup>3</sup> /min 0.43 in <sup>3</sup> /min	10 cm <sup>3</sup> /min 0.61 in <sup>3</sup> /min	15 cm <sup>3</sup> /min 0.92 in <sup>3</sup> /min
Fluid		Mineral base oil		
Fluid temperature	with NBR seals	da -20° a 80°C		
	with FPM seals	da -20° a 100°C		
Viscosity	operating range	da 15 a 75 mm <sup>2</sup> /s - from 15 to 75 cSt		
	minimum	12 mm <sup>2</sup> /s - 12 cSt		
	maximum	400 mm <sup>2</sup> /s - 400 cSt		
Max. level of contamination		19/16 - ISO 4406		
Ambient temperature		da -40° a 60°C		

NOTE - For different working conditions please contact Customer Service.

(\*) - This value is reachable only in steady conditions; for dynamic working conditions see the pages from 49 to 52.

Standard threads

ALL PORTS	BSP (ISO 228/1)	UN-UNF (ISO 11926-1)
DFE052	G 3/8	3/4-16 UNF-2B (SAE 8)
DFE10	G 1/2	7/8-14 UNF-2B (SAE 10)
DFE20	G 3/4	1 1/16-12 UN-2B (SAE 12)
DRAIN PORT		
L	G 1/4	7/16-20 UNF-2B (SAE 4)



with solenoid control

DFE

Hydraulic circuit

2-way

Available as body only in DFE052/2 execution; for other executions 3-way body is used.

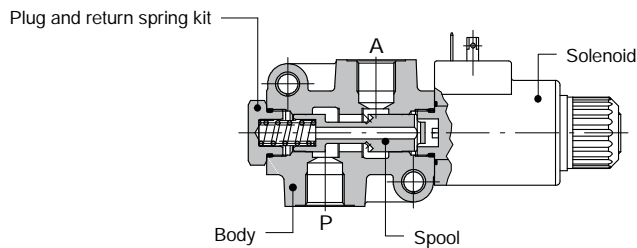

Spool type A

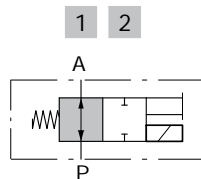

Spool type B

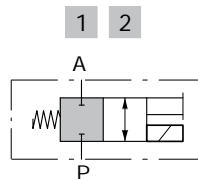

Performance data

Pressure drop versus flow  
P→A

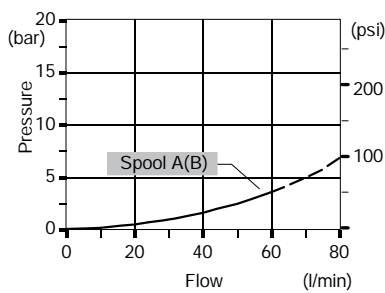

Minimum dynamic conditions  
(supply = Vn-10%, coil at 70 °C)

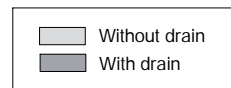
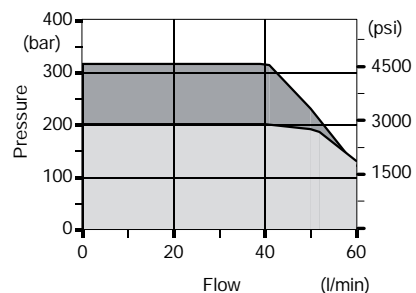

DFE

with solenoid control

Hydraulic circuit

3-way

It's possible to obtain 2-way diverter valve plugging port A or B.

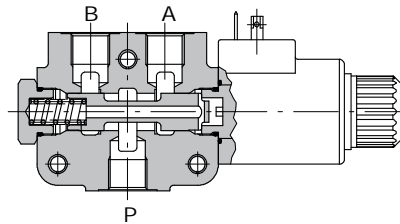

Spool type A

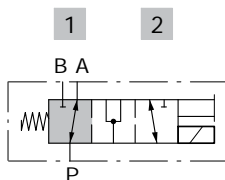

Spool type B

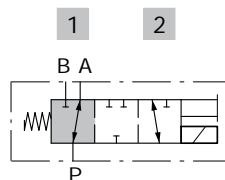

Spool type D

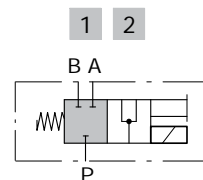

Performance data

Pressure drop versus flow: P→A(B)

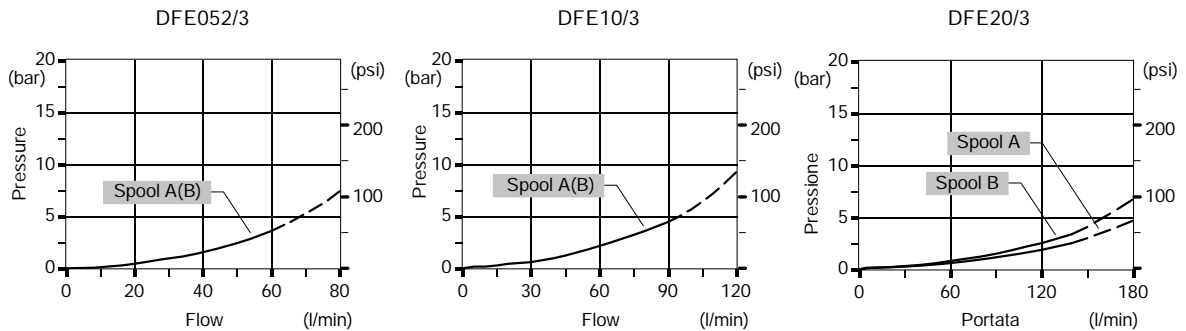

Minimum dynamic conditions: (supply = Vn-10%, coil at 70 °C)

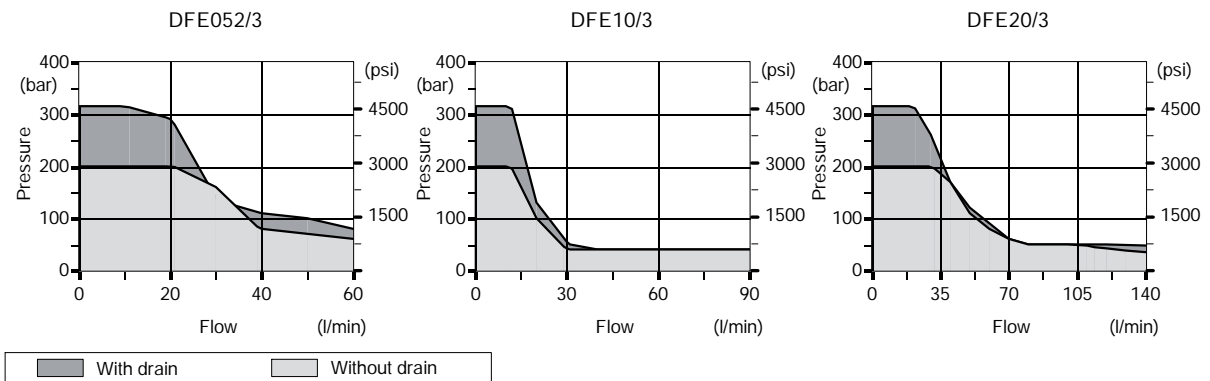

with solenoid control

DFE

Hydraulic circuit

6-way

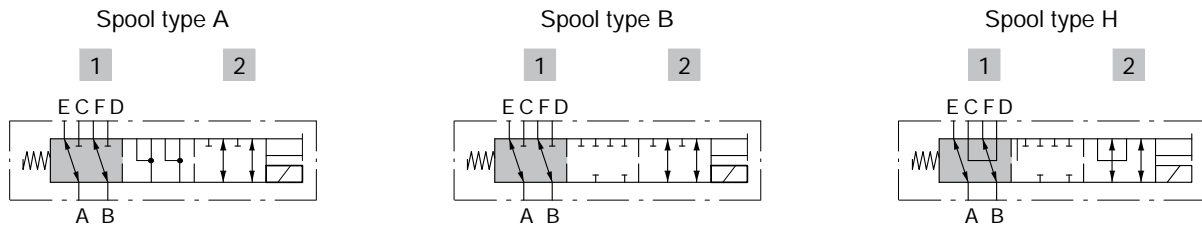
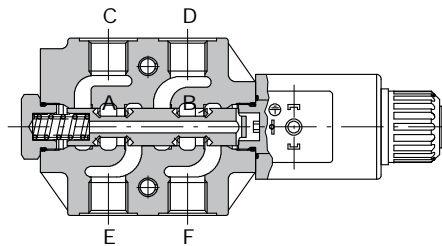

Performance data

Pressure drop versus flow: A→E(C).

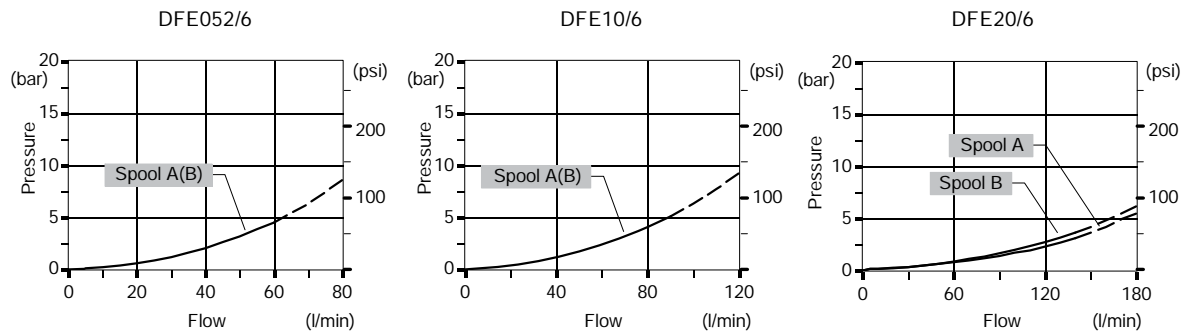

Minimum dynamic conditions: (supply = Vn-10%, coil at 70 °C)

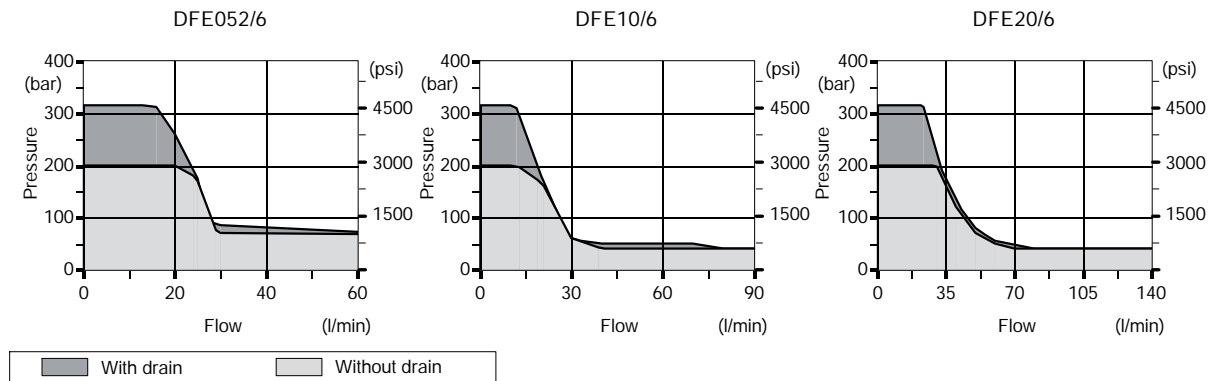

DFE

with solenoid control

Hydraulic circuit

8-way

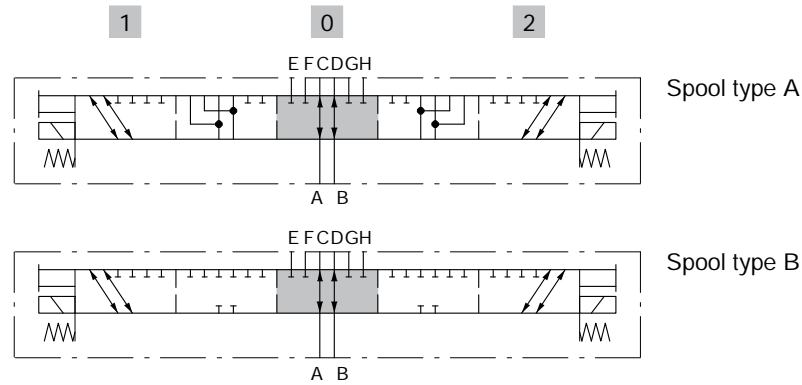
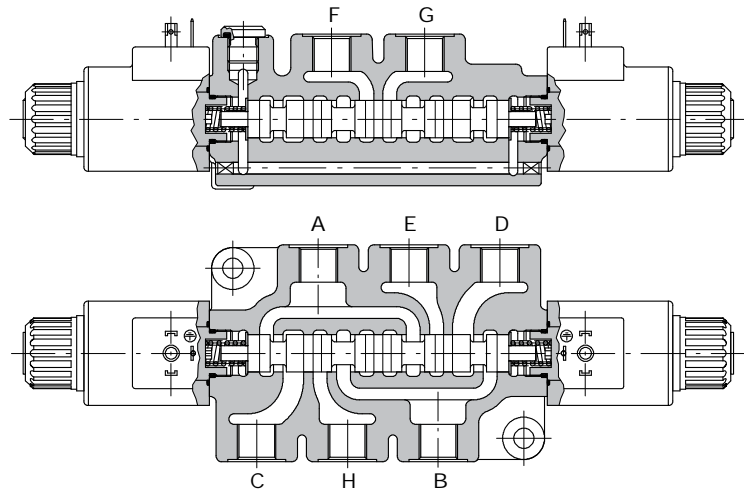

Performance data

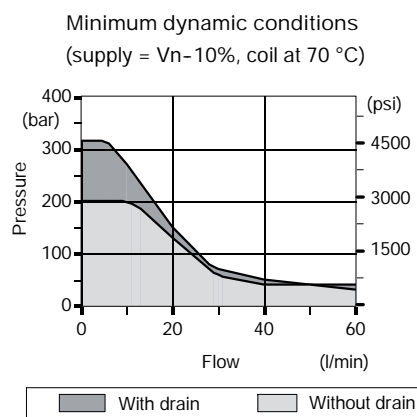
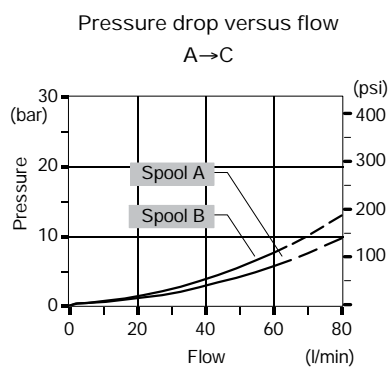

with solenoid control

DFE10

Dimensional data

3-way DFE10/3 valve

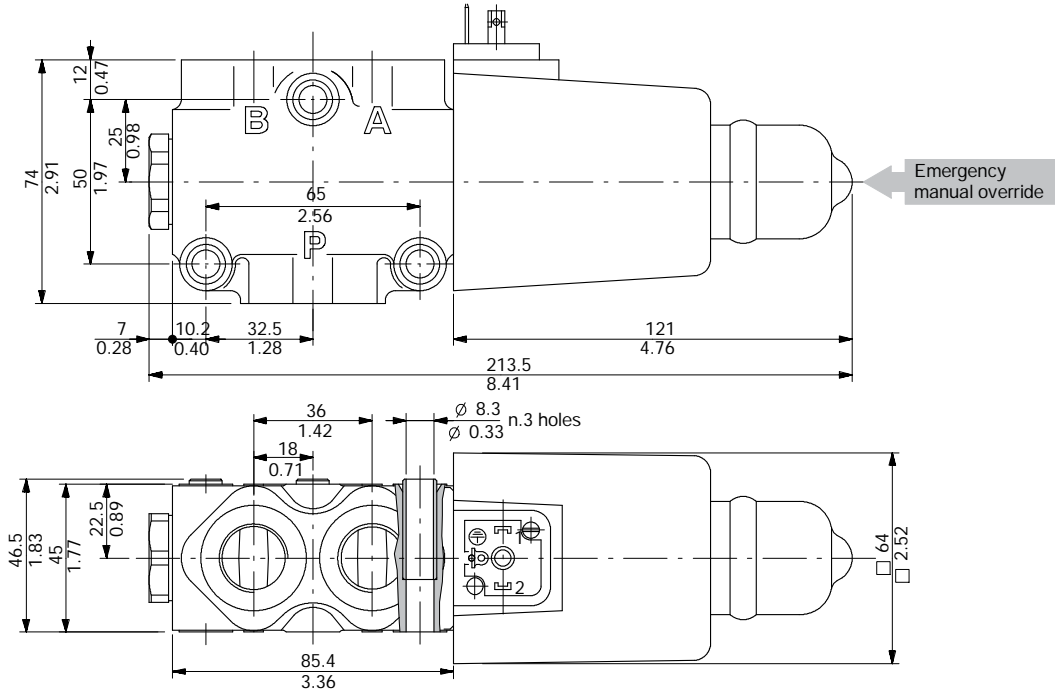

6-way DFE10/6 valve

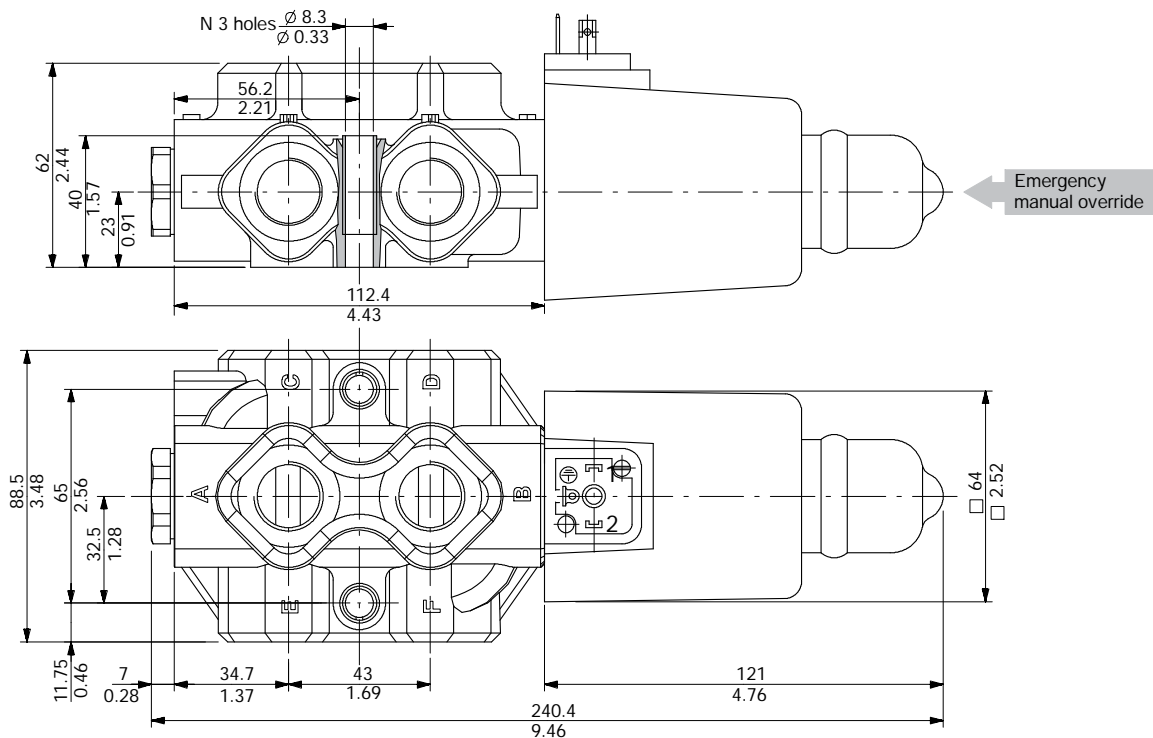

DFE10

with solenoid control

Ordering codes

Description example :

Diverter valve DFE10/3 A 18 ES - W 202-12VDC - <CVN>

1. 2. 3. 4. 3. 5.

Valve is supplied painted as standard, with one coat of Primer black antirust paint

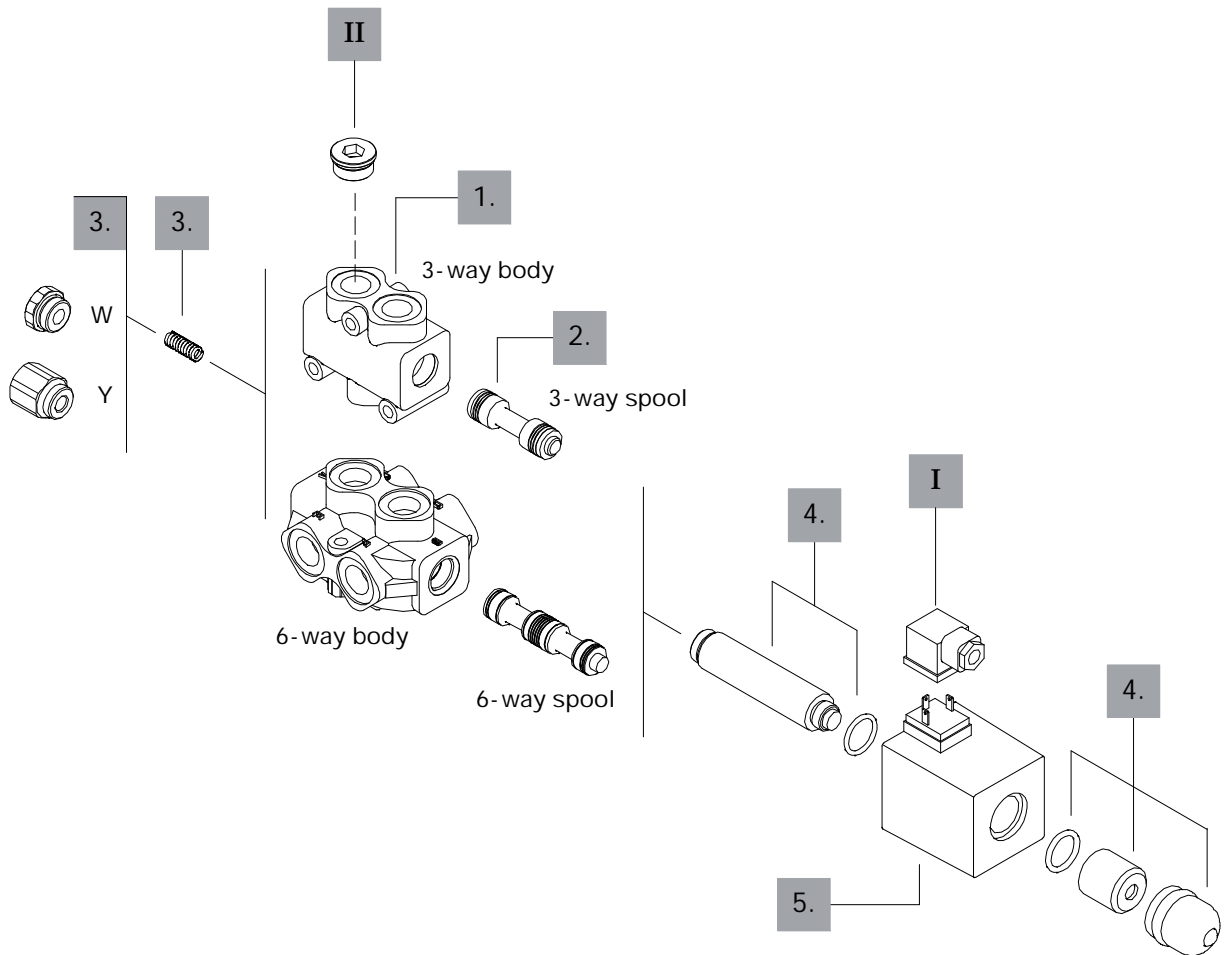





with solenoid control

DFE10

Ordering codes

3-way

1. Body \*

TYPE	CODE	DESCRIPTION
DFE10/3	3CO2241320	Standard body, BSP threaded

2. Spool options

TYPE	CODE	DESCRIPTION
A	3CAS110341	3-way, 2 positions with ports connected in transit position
B	3CAS110441	3-way, 2 positions with ports closed in transit position
D	3CAS110540	3-way, 2 positions, without transit position, with ports closed in rest position

6-way

1. Body \*

TYPE	CODE	DESCRIPTION
DFE10/6	3CO2242322	Standard body, BSP threaded

2. Spool options

TYPE	CODE	DESCRIPTION
A	3CAS110641	6-way, 2 positions with ports connected in transit position
B	3CAS110741	6-way, 2 positions with ports closed in transit position
H	3CAS110840	6-way, 2 positions, D↔C in position 1, F↔E in position 2, ports closed in transit position
N	3CAS110952	6-way, 2 positions with ports closed in transit position, with check valve

3. Positioner kits page 64

TYPE	CODE	DESCRIPTION
18...W	5TAP002	Spring return in position 1
18...Y	5GIU004 *	Spring return in position 1, with G1/4 drain port

4. Tube assembly page 64

TYPE	CODE	DESCRIPTION
ES	5SOL516000	Spring return in position 1 (without coil)

5. Coil options page 64

TYPE	CODE	DESCRIPTION
102	-	Without coil (only with tube kit)
VDC supply (connector C02)		
202-12VDC	4SOL516012	Coil with 12VDC nominal voltage
202-24VDC	4SOL516024	Coil with 24VDC nominal voltage
202-48VDC	4SOL516048	Coil with 48VDC nominal voltage
VAC supply (connector C04)		
202-92VDC	4SOL516094	Coil with 92VDC nominal voltage (for 110VAC)
202-192VDC	4SOL516192	Coil with 192VDC nominal voltage (for 220VAC)

I Optional connectors page 80

TYPE	CODE	DESCRIPTION
C02	2X1001010	According ISO4400
C04	2X1001040	According to ISO4400 with rectifier

II Ports plug

TYPE	CODE	DESCRIPTION
G1/2	3XTAP727180*	Body conversion from 3-way to 2-way circuit

NOTE (\*) - Codes are referred to BSP thread.



DFE10

with solenoid control

Positioner kits

18W kit

Spring return in position 1 with plug.

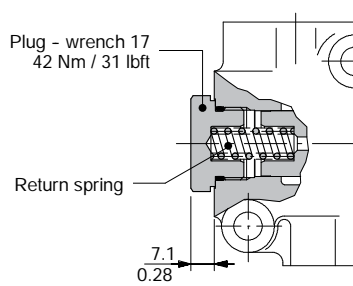

18Y kit

Spring return in position 1, with G1/4 joint for drain.

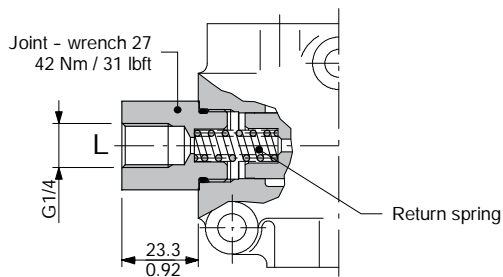

with solenoid control

DFE10

Solenoid parts

ES tube assembly

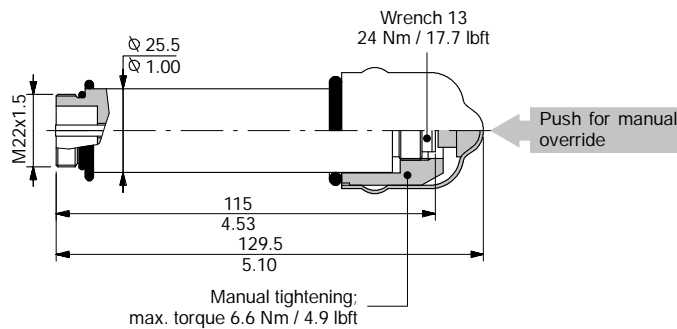

Operating features

Plunger stroke . . . . . : 10.2 mm / 0.40 in

Coil options

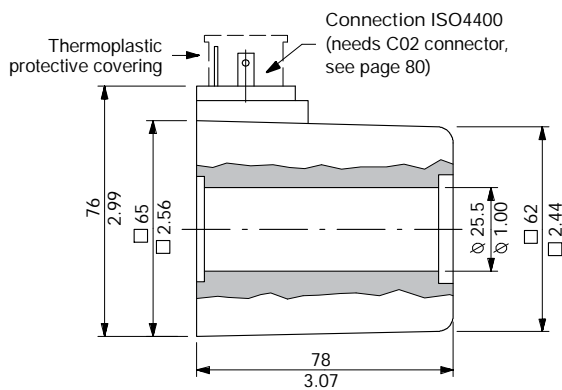

Operating features

Nominal voltage . . . . . : 12-24-48-92-192VDC

Nominal voltage tolerance . . . :  $\pm 10\%$

Power rating . . . . . : 60 W

Duty cycle . . . . . : 100%

Weather protection . . . . . : IP66

Coil insulation . . . . . : Class H