

Technical data

Technical data

Frame size		4,0	6,0	8,0	011	014	017	019	022	025
Displacement	cm ³ /rev	3.9	6.0	8.4	10.8	14.4	16.8	19.2	22.8	25.2
	[in ³ /rev]	[0.24]	[0.37]	[0.51]	[0.66]	[0.88]	[1.02]	[1.17]	[1.39]	[1.54]
SNP2NN										
Peak pressure	bar [psi]	280	280	280	280	280	280	230	200	175
		[4060]	[4060]	[4060]	[4060]	[4060]	[4060]	[3335]	[2900]	[2638]
Rated pressure		250	250	250	250	250	250	210	180	160
		[3625]	[3625]	[3625]	[3625]	[3625]	[3625]	[3045]	[2610]	[2320]
Minimum speed at 0-100 bar	min ⁻¹ (rpm)	600	600	600	500	500	500	500	500	500
Minimum speed at 100-180 bar		1200	1200	1000	800	750	750	700	700	700
Min. speed at 180 bar to rated pressure		1400	1400	1400	1200	1000	1000	1000	800	–
Maximum speed		4000	4000	4000	4000	3500	3000	3000	3000	3000
SKP2NN										
Peak pressure	bar [psi]	280	280	280	280	280	280	260	230	200
		[4060]	[4060]	[4060]	[4060]	[4060]	[4060]	[3770]	[3335]	[2900]
Rated pressure		250	250	250	250	250	250	240	210	190
		[3625]	[3625]	[3625]	[3625]	[3625]	[3625]	[3480]	[3045]	[2755]
Minimum speed at 0-100 bar	min ⁻¹ (rpm)	600	600	600	500	500	500	500	500	500
Minimum speed at 100-180 bar		1200	1200	1000	800	750	750	700	700	700
Min. speed at 180 bar to rated pressure		1400	1400	1400	1200	1000	1000	1000	800	800
Maximum speed		4000	4000	4000	4000	3500	3000	3000	3000	3000
Both (SNP2NN, SKP2NN)										
Weight	kg [lb]	2.3	2.4	2.5	2.7	2.9	3.0	3.1	3.2	3.3
		[5.1]	[5.3]	[5.5]	[5.8]	[6.3]	[6.5]	[6.7]	[7.0]	[7.3]
Moment of inertia of rotating components	x 10 ⁻⁶ kg·m ² [x 10 ⁻⁶ lb·ft ²]	21.3	26.5	32.4	38.4	47.3	53.3	59.2	68.1	74.1
		[505]	[629]	[769]	[911]	[1122]	[1265]	[1405]	[1616]	[1758]
Theoretical flow at maximum speed	l/min [US gal/min]	15.6	24.0	33.6	43.2	50.4	50.4	57.6	68.4	75.6
		[4.1]	[6.3]	[8.9]	[11.4]	[13.3]	[13.3]	[15.2]	[18.0]	[20.0]

1 kg·m² = 23.68 lb·ft²

⚠ Caution

The rated and peak pressure mentioned are for pumps with flanged ports only. When threaded ports are required a de-rated performance has to be considered. To verify the compliance of an high pressure application with a threaded ports pump apply to a Turolia OCG representative.

Group 2 Gear Pumps Technical Information Product Coding

Model code

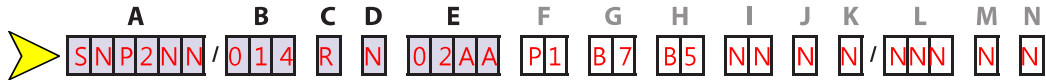

A Type

SNP2NN	Standard gear pump
SNP2IN	Standard gear pump, internal drain, integrated relief valve
SNP2EN	Standard gear pump, external drain, integrated relief valve
SNC2NN	Standard gear pump, inlet/outlet in the cover
SKP2NN	High torque gear pump
SKP2IN	High torque gear pump, internal drain, integrated relief valve
SKP2EN	High torque gear pump, external drain, integrated relief valve
SKC2NN	High torque gear pump, inlet/outlet in the cover
SHP2NN	High pressure gear pump

B Displacement

4,0	3.9 cm ³ /rev [0.24 in ³ /rev]
6,0	6.0 cm ³ /rev [0.37 in ³ /rev]
8,0	8.4 cm ³ /rev [0.51 in ³ /rev]
011	10.8 cm ³ /rev [0.66 in ³ /rev]
014	14.4 cm ³ /rev [0.88 in ³ /rev]
017	16.8 cm ³ /rev [1.02 in ³ /rev]
019	19.2 cm ³ /rev [1.17 in ³ /rev]
022	22.8 cm ³ /rev [1.39 in ³ /rev]
025	25.2 cm ³ /rev [1.54 in ³ /rev]

C Direction of rotation

R	Right (Clockwise)
L	Left (Counterclockwise)

D Version

N	Standard gear pump
2	Standard gear pump, big shaft

Legend:	
●	Standard
○	Optional
-	Not Available

E Mounting flange / drive gear

Code	Description (Type of flange • Type of drive gear • Preferred ports for configuration)	SNP2NN	SNP2IN	SNP2EN	SNC2NN	SKP2NN	SKP2IN	SKP2EN	SKC2NN	SHP2NN
01FA	European four bolts flange • Parallel shaft 15 mm [0.591 in] • European flanged ports	●	●	-	-	-	-	-	-	-
01BA	European four bolts flange • Tapered 1:8 shaft • European flanged ports	●	●	-	●	-	-	-	-	●
01DA	European four bolts flange • Splined 15T 12x10 shaft • European flanged ports	●	●	●	-	-	-	-	-	●
02AA	German four bolts PTO flange • Tapered 1:5 shaft • German flanged ports	●	●	-	-	-	-	-	-	●
02DB	German four bolts PTO flange • DIN splined shaft • German flanged ports	●	●	-	-	-	-	-	-	-
03CA	Turolia OCG Tang flange • Turolia OCG Tang shaft • German flanged ports	●	●	●	-	-	-	-	-	-
91DB	European four bolts flange Outtrigger bearing • Tapered 1:8 shaft key 4 • European flanged ports	●	-	-	-	-	-	-	-	-
9ADB	European four bolts flange Outtrigger bearing • Tapered 1:8 shaft key 3.2 • European flanged ports	●	-	-	-	-	-	-	-	-
94DB	German two bolts PTO flange (Deutz) Outtrigger bearing • Tapered 1:5 shaft • German flanged ports	●	-	-	-	-	-	-	-	-
9JDB	SAE A flange Outtrigger bearing • Parallel shaft 19.05mm [0.750 in] • SAE O-ring boss ports	●	-	-	-	-	-	-	-	-
04AA	German two bolts PTO flange (Deutz) • Tapered 1:5 shaft • German flanged ports	●	-	-	-	-	-	-	-	●
04DB	German two bolts PTO flange (Deutz) • DIN splined shaft • German flanged ports	●	-	-	-	-	-	-	-	●
05AA	German two bolts PTO flange (Deutz) • Tapered 1:5 shaft • German flanged ports	●	-	-	-	-	-	-	-	●
05DB	German two bolt PTO flange (Deutz) • DIN splined shaft • German flanged ports	●	-	-	-	-	-	-	-	●
06GA	SAE A flange • Parallel shaft 15.875 mm [0.625 in] • SAE O-ring boss ports	●	-	-	-	-	-	-	-	-
06SA	SAE A flange • SAE splined 9T shaft • SAE O-ring boss ports	●	●	●	-	-	-	-	-	-
06SB	SAE A flange • SAE splined 11T shaft • SAE O-ring boss ports	-	-	-	-	●	●	●	●	-
09BJ	Perkins 4.236 timing case flange • Tapered 1:8 shaft • German std port X pattern ports	●	-	-	-	-	-	-	-	-
A9BJ	Perkins 900 series flange • Tapered 1:8 shaft • German std port X pattern ports	●	-	-	-	-	-	-	-	-

Group 2 Gear Pumps Technical Information Product Coding

Model code
(continued)

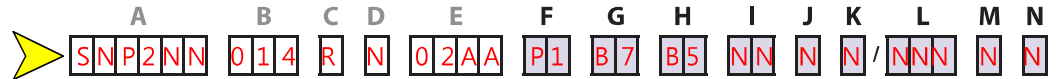

F Rear cover

P1	Standard cover for pump
P3	Cover for 03 flange only
C1	Front BSP ports: Inlet 3/4 GAS Outlet 1/2 GAS
C6	Front SAE thd ports: Inlet 1 1/16-12UN-2B Outlet 7/8-14UNF-2B
E1	Cover for RV external drain 3/8 GAS
E3	Cover for RV ext. drain 3/8 GAS holes M5
E6	Cover for RV ext. drain 3/4 -16UNF-2B
I1	Cover for RV internal drain
I3	Cover for RV int. drain for 03 flange only

I Port position and variant body

NN	Standard from catalogue
YY	Port Bx-Bx for SAE flange off-set from center of body as per catalogue
ZZ	Port Bx-Bx in center of body

J Sealing

N	Standard Buna seal
A	Without shaft seal
B	VITON seal
L	Std. shaft seal turned over assembled

G Inlet port

H Outlet port

B5	15x35xM6	Flanged port 4 threaded holes in X pattern, in center or off-set of body
B6	15x40xM6	
B7	20x40xM6	
BB	27x55xM8	
C2	12x26xM5	Flanged port 4 threaded holes in + pattern (European standard ports)
C3	13,5x30xM6	
C5	13,5x40xM8	
C7	20x40xM8	
C8	23,5x40xM8	
D4	M16x1,5	Threaded metric port
D5	M18x1,5	
D7	M22x1,5	
D9	M26x1,5	
E3	9/16-18UNF	Threaded SAE O-Ring boss port
E4	3/4-16UNF	
E5	7/8-14UNF	
E6	1 1/16-12UN	
E8	1 5/16-12UN	
F3	3/8 GAS	Threaded GAS (BSPP) port
F4	1/2 GAS	
F5	3/4 GAS	
F6	1 GAS	
H5	M18x1,5	Threaded metric port ISO 6149
H7	M22x1,5	
H8	M27x2	
H9	M33x2	

K Screws

N	Standard screws
A	Galvanized screws + nut-washers
B	DACROMET/GEOMET screws

L Set valve

NNN	No valve
V**	Integral relief valve pressure setting

M Marking

N	Standard marking
A	Standard marking + Customer code
Z	Without marking



N Mark position

N	Standard marking position
A	Mark on the bottom ref. to drive gear

Group 2 Gear Pumps Technical Information Product Options

Flange, shaft and ports configurations

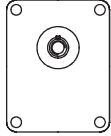
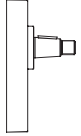
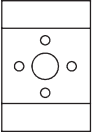
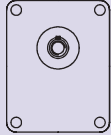
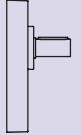
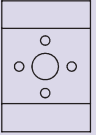
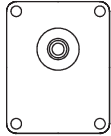
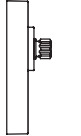
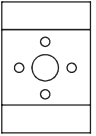
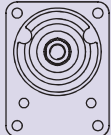
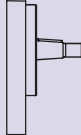
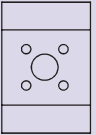
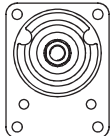
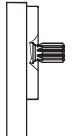
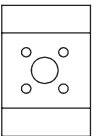
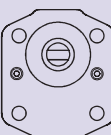
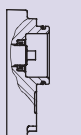
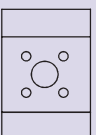
Available flange, shaft and ports configurations

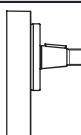
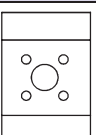
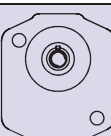
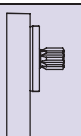
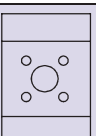
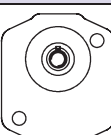
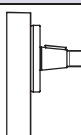
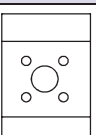
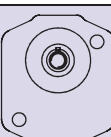
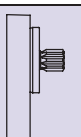
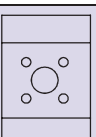
Code	Flange	Shaft	Ports
01BA	pilot Ø 36.5 mm [1.438 in] European 01, 4-bolt 	1:8 tapered 	European flanged, + pattern 
01FA	pilot Ø 36.5 mm [1.438 in] European 01, 4-bolt 	Ø 15 mm [0.59 in] parallel 	European flanged, + pattern 
01DA	pilot Ø 36.5 mm [1.438 in] European 01, 4-bolt 	Splined 9T - m 1.60 DIN 5482-B17x14 	European flanged, + pattern 
02AA	pilot Ø 80 mm [3.15 in] German PTO, 4-bolt 	1:5 tapered 	German std., X pattern 
02DB	pilot Ø 80 mm [3.15 in] German PTO, 4-bolt 	Splined 9T - m 1.60 DIN 5482-B17x14 	German std., X pattern 
03CA	Turolla OCG 03 	Turolla OCG tang 	German std., X pattern 
04AA	pilot Ø 50 mm [1.969 in] German PTO, 2-bolt 	1:5 tapered 	German std., X pattern 
04DB	pilot Ø 50 mm [1.969 in] German PTO, 2-bolt 	Splined 9T - m 1.60 DIN 5482-B17x14 	German std., X pattern 
05AA	pilot Ø 50 mm [1.969 in] German PTO, 2-bolt 	1:5 tapered 	German std., X pattern 
05DB	pilot Ø 50 mm [1.969 in] German PTO, 2-bolt 	Splined 9T - m 1.60 DIN 5482-B17x14 	German std., X pattern 

Pump ports

Available pump ports

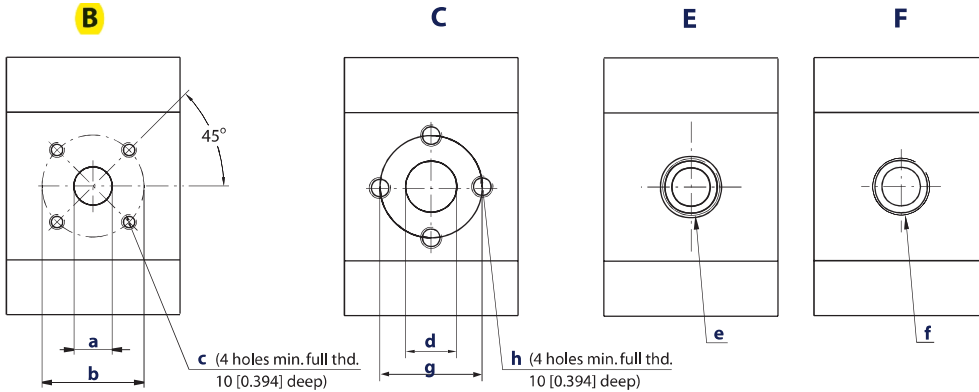

Dimensions of pumps ports

Port type		B			C			E	F	
Port dimensions		a	b	c	d	g	h	e	f	
Frame size	4,0	Inlet	15 [0.591]	40 [1.575]	M6	13.5 [0.531]	30 [1.181]	M6	1 1/16-12UNF-2B	1/2 Gas (BSPP)
		Outlet	15 [0.591]	35 [1.378]	M6	13.5 [0.531]	30 [1.181]	M6	7/8-14UNF-2B	1/2 Gas (BSPP)
	6,0	Inlet	15 [0.591]	40 [1.575]	M6	13.5 [0.531]	30 [1.181]	M6	1 1/16-12UNF-2B	1/2 Gas (BSPP)
		Outlet	15 [0.591]	35 [1.378]	M6	13.5 [0.531]	30 [1.181]	M6	7/8-14UNF-2B	1/2 Gas (BSPP)
	8,0	Inlet	20 [0.787]	40 [1.575]	M6	13.5 [0.531]	30 [1.181]	M6	1 1/16-12UNF-2B	1/2 Gas (BSPP)
		Outlet	15 [0.591]	35 [1.378]	M6	13.5 [0.531]	30 [1.181]	M6	7/8-14UNF-2B	1/2 Gas (BSPP)
	011	Inlet	20 [0.787]	40 [1.575]	M6	13.5 [0.531]	30 [1.181]	M6	1 1/16-12UNF-2B	3/4 Gas (BSPP)
		Outlet	15 [0.591]	35 [1.378]	M6	13.5 [0.531]	30 [1.181]	M6	7/8-14UNF-2B	1/2 Gas (BSPP)
	014	Inlet	20 [0.787]	40 [1.575]	M6	20.0 [0.787]	40 [1.575]	M8	1 1/16-12UNF-2B	3/4 Gas (BSPP)
		Outlet	15 [0.591]	35 [1.378]	M6	13.5 [0.531]	30 [1.181]	M6	7/8-14UNF-2B	1/2 Gas (BSPP)
	017	Inlet	20 [0.787]	40 [1.575]	M6	20.0 [0.787]	40 [1.575]	M8	1 1/16-12UNF-2B	3/4 Gas (BSPP)
		Outlet	15 [0.591]	35 [1.378]	M6	13.5 [0.531]	30 [1.181]	M6	7/8-14UNF-2B	1/2 Gas (BSPP)
	019	Inlet	20 [0.787]	40 [1.575]	M6	20.0 [0.787]	40 [1.575]	M8	1 1/16-12UNF-2B	3/4 Gas (BSPP)
		Outlet	15 [0.591]	35 [1.378]	M6	13.5 [0.531]	30 [1.181]	M6	7/8-14UNF-2B	1/2 Gas (BSPP)
	022	Inlet	20 [0.787]	40 [1.575]	M6	20.0 [0.787]	40 [1.575]	M8	1 1/16-12UNF-2B	3/4 Gas (BSPP)
		Outlet	15 [0.591]	35 [1.378]	M6	13.5 [0.531]	30 [1.181]	M6	7/8-14UNF-2B	1/2 Gas (BSPP)
025	Inlet	20 [0.787]	40 [1.575]	M6	23.5 [0.925]	40 [1.575]	M8	1 1/16-12UNF-2B	1 Gas (BSPP)	
	Outlet	15 [0.591]	35 [1.378]	M6	20.0 [0.787]	40 [1.575]	M8	7/8-14UNF-2B	3/4 Gas (BSPP)	

SNP2NN – 02DB and 02AA

Standard porting for 02DB and 02AA

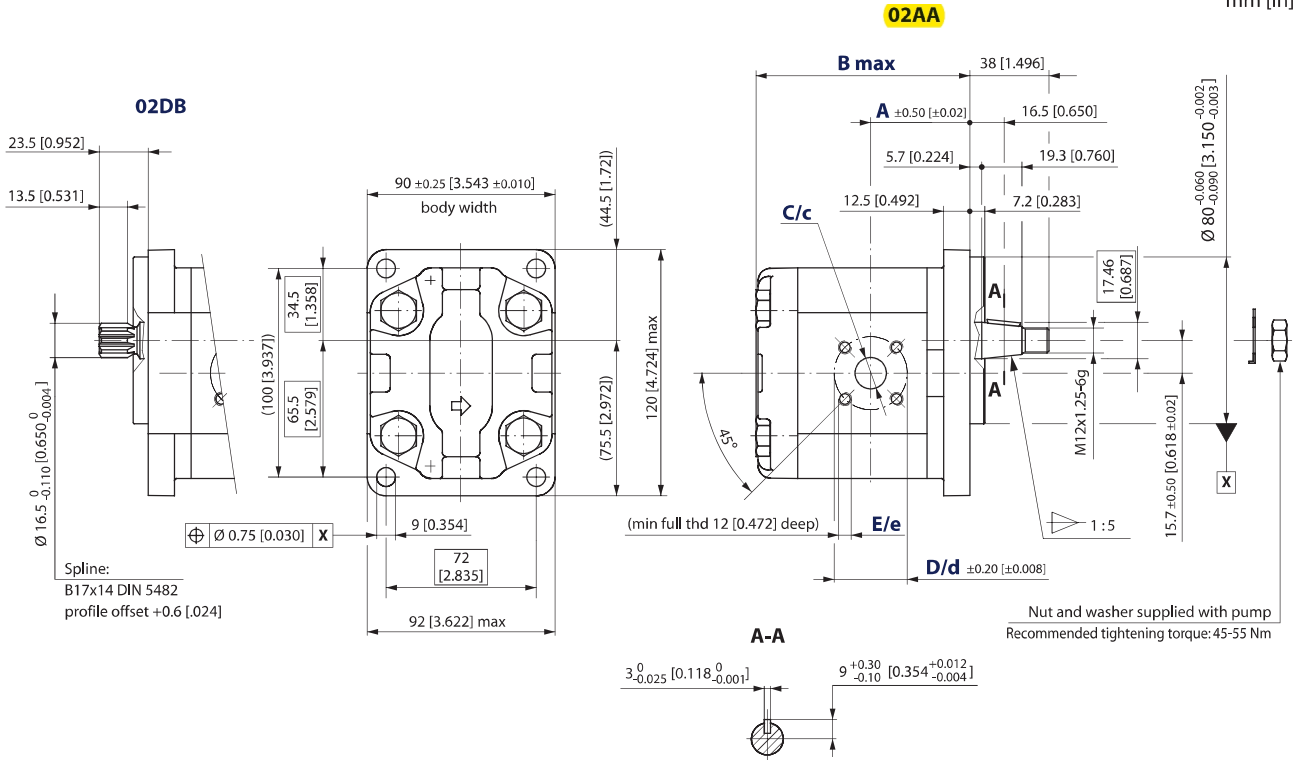

SNP2NN – 02DB and 02AA dimensions

Frame size		4,0	6,0	8,0	011	014	017	019	022	025
Dimension	A	39.8 [1.567]	41.1 [1.618]	43.1 [1.697]	47.5 [1.870]	47.5 [1.870]	47.5 [1.870]	47.5 [1.870]	55 [2.165]	64.5 [2.539]
	B	92.5 [3.642]	96 [3.780]	100 [3.937]	104 [4.094]	110 [4.331]	114 [4.488]	118 [4.646]	124 [4.882]	128 [5.039]
Inlet	C	15 [0.591]	15 [0.591]	20 [0.787]	20 [0.787]	20 [0.787]	20 [0.787]	20 [0.787]	20 [0.787]	20 [0.787]
	D	40 [1.575]								
	E	M6								
Outlet	c	15 [0.591]								
	d	35 [1.378]								
	e	M6								

Model code examples and maximum shaft torque

Flange/drive gear	Model code example	Maximum shaft torque
02DB	SNP2NN/017LN02DBP1B7B5NNNN/NNNNN	130 N·m [1151 lbf·in]
02AA	SNP2NN/6,0RN02AAP1B6B5NNNN/NNNNN	140 N·m [1239 lbf·in]

For further details on ordering, see *Model Code*, pages 8÷9.