

**EAT•N**

**Vickers**

**Proportional Directional Control Valves  
Two-Stage Models Without Electrical  
Feedback**

KBDG5V-5-1\*  
KBDG5V-7-1\*  
KBDG5V-8-1\*  
KBDG5V-10-1\*

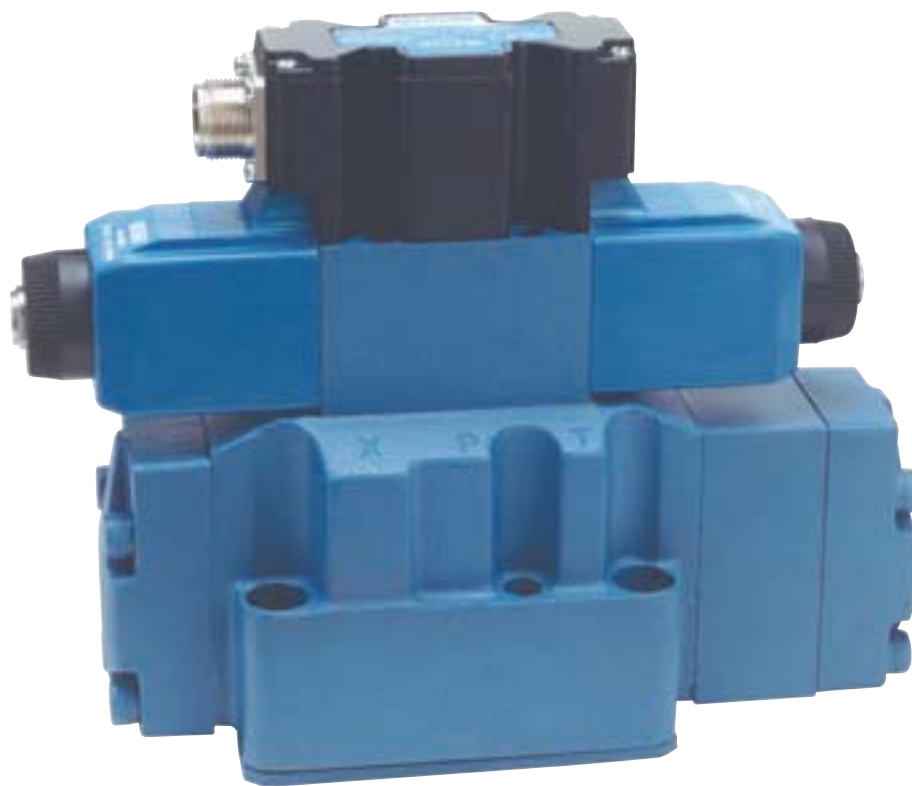

# Contents

<b>General Description</b>	Page 3
<b>Typical Section</b>	Page 3
<b>Model Codes</b>	Page 4
<b>Spool Data</b>	Page 5
<b>Functional Symbols</b>	Page 6
<b>Operating Data</b>	Page 7
<b>Performance Characteristics</b>	Page 8
<b>Power Capacity Envelopes</b>	Page 9
<b>Flow Characteristics</b>	
KBDG5V-7/8	Page 10
KBDG5V-10	Page 11
<b>Step Response</b>	Page 12
<b>Installation Dimensions</b>	
KBDG5V-5/7/10	Page 13
Pilot Supply and Drain Plugs	Page 14
Mounting Faces	Page 15
<b>Electrical Information</b>	
Block Diagram	Page 16
Typical Connection Arrangements	Page 17
<b>Application Data</b>	Page 18



*This product has been designed and tested to meet specific standards outlined in the European Electromagnetic Compatibility Directive (EMC) 89/336/EEC, amended by 91/263/EEC, 92/31/EEC and 93/68/EEC, article 5. For instructions on installation requirements to achieve effective protection levels, see this leaflet and the Installation Wiring Practices for Vickers™ Electronic Products leaflet 2468. Wiring practices relevant to this Directive are indicated by  Electromagnetic Compatibility (EMC).*

# General Description

Vickers™ KBDG5V-5/7/8/10 are solenoid operated directional control, non-feedback type proportional valves.

These are two-stage proportional directional control valves in which the main-stage spool is positioned according to the output from an integrally mounted proportional, solenoid-operated, pressure-reducing valve. Direction of main-spool travel depends upon which of the two solenoids of the pilot

valve is energized and the amount of travel is dependent upon the current input to the solenoid.

At any intermediate position of the main spool, a force balance exists between the controlled, reduced pilot pressure acting on the spool end and the opposing centering spring, plus the action of flow forces. There is no electrical feedback of the main-stage spool position.

This range of valves offers effective and economic solutions for applications having repetitive load conditions throughout each operating cycle, e.g. mold closure /opening in plastics molding machinery.

### Standard Features and Benefits

- These global products, manufactured to world-class quality standards, are sold and serviced throughout the world.

- These valves open up expanded application opportunities as a cost effective alternative to feedback-type proportional and servo valves.
- Auxiliary DIN-rail mounted function modules available.

## Typical Section

### KBDG5V-7 Without Integral Pilot Pressure Reducer

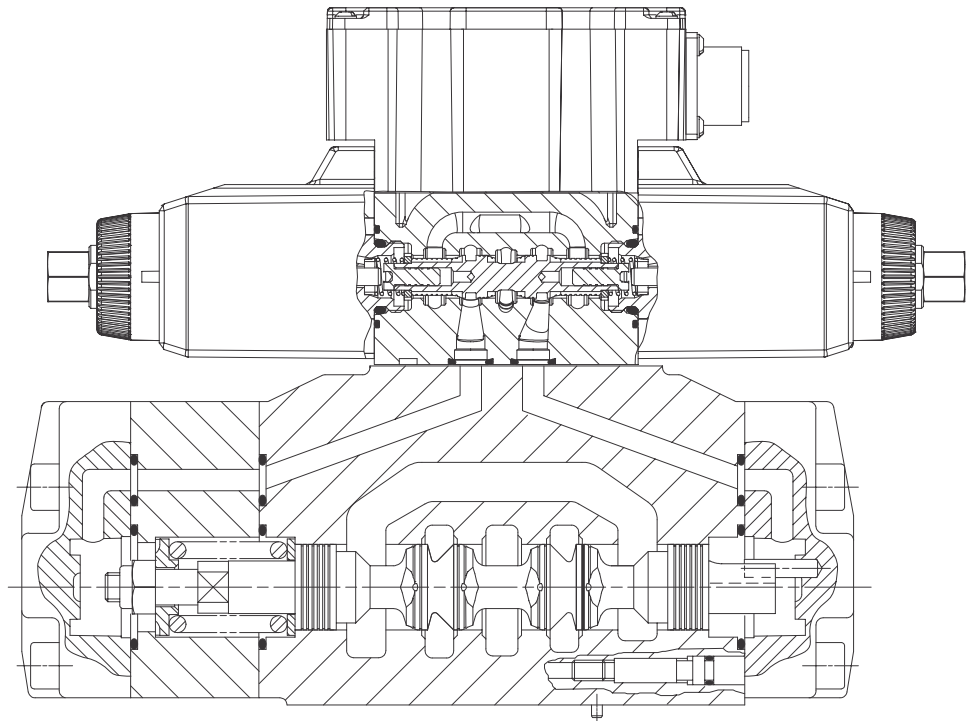

# Model Codes

**KBDG5V - \* - \*\*\* C \*\*\* N (\*\*\*) (\*\*) (T) (\*) M\* P\*7 \*1 1\***

1 2 3 4 5 6 7 8 9 10 11 12 13 14

- 1 Model Series**
- KB** – Proportional valve with integral amplifier, B series
  - D** – Directional valve
  - G** – Subplate mounted
  - 5** – Solenoid controlled/pilot operated
  - V** – Pressure rating on P, A & B ports  
Sizes 7, 8 and 10: 350 bar (5000 psi)  
Size 5: 315 bar (4500 psi)

- 2 Mounting Interface Size (ISO 4401)**
- 5 – NFPA D05, CETOP 5
  - 7** – NFPA D07, CETOP 7
  - 8 – NFPA D08, CETOP 8
  - 10 – NFPA D10, CETOP 10

- 3 Spool Type**  
See “Spool Data”, page 5
- 2** – All ports blocked when spool centered
  - 7 – Open P to A&B
  - 12 – All ports blocked when spool centered, regenerative function when spool energized
  - 33/133 – Bleed A and B to T when spool centered

- 4 Spool / Spring Arrangement**
- C** – Spool spring centered

- 5 Flow Rating**  
See “Spool Data”, page 5  
Flow rating (L/min) for symmetric spools  
“A” port flow rating (L/min) for asymmetric spools

- 6 Spool Metering Type**
- N – Meter-in and meter-out

- 7 Flow Rating**  
See “Spool Data”, page 5  
“B” port flow rating (L/min) for asymmetric spools

- 8 Pilot Supply**  
Models without integral, fixed pilot pressure reducer module
- E – External pilot supply
  - Blank** – Internal pilot supply

- Models with integral, fixed pilot pressure reducer module
- X – Internal pilot supply
  - EX – External pilot supply
- For system pressures less than 200 bar (2900 psi) the pilot pressure reducing module is optional.
- For system pressures above 200 bar (2900 psi) the pilot pressure reducing module must be fitted.

- 9 Pilot Drain**
- T – Internal pilot drain
  - Blank** – External pilot drain

- 10 Manual Override**
- Blank** – Plain overrides
  - H – Water-resistant overrides
  - Z – No overrides

- 11 Electrical Command Option**
- 1** – +/- 10V control signal
  - 2 – 4-20 mA control signal

- 12 Electrical Connection**
- PC7 – 7 pin connector without plug supplied
  - PE7** – 7 pin connector with plug supplied
  - PH7 – As PE7 but with pin “C” used for enable signal
  - PR7 – As PC7 but with pin “C” used for enable signal

- 13 Coil Identification**
- H** – 24V

- 14 Design Number, 10 Series**  
Subject to change. Installation dimensions unaltered for design numbers 10 to 19 respectively



## Warning

Valves with integral amplifiers are supplied with or without the metal 7-pin plug. The Vickers™ plug, part no. 934939, must be correctly fitted to ensure that the EMC rating and IP67 rating are achieved. The plug retaining nut must be tightened to 2-2,5 Nm (1.5-2.0 lbf ft) to effect a proper seal.

# Spool Data

## Spool Symbols

Simplified symbols including transient flow conditions (dotted line).

Spool type 2C

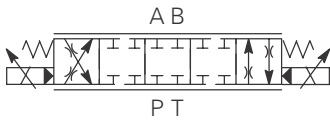

Spool type 7C

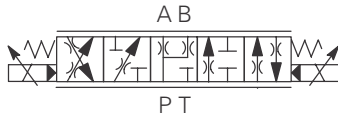

Spool type 12C

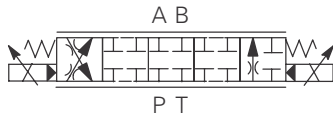

Spool type 33C

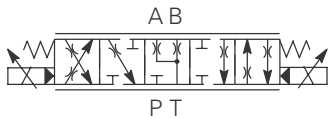

Spool type 133C with typical regenerative circuit

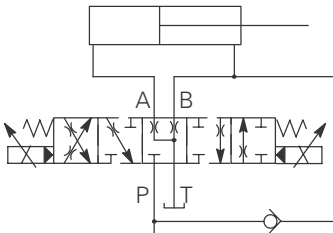

## Spool Types and Flow Ratings

### Symmetric Spools

Flow ratings for flow through P-A-B-T at  $\Delta p = 5$  bar (72 psi) per flow path, e.g. P-A, or B-T. For other pressure drop values see "Flow Gain" curves on pages 10 and 11.

SPOOL CODE	MAIN STAGE SPOOL SYMBOL	FLOW RATING
<b>For KBDG5V-5 valves:</b>		
2C90N	2C	90 L/min (24 USgpm)
33C80	33C	80 L/min (21 USgpm)
<b>For KBDG5V-7 valves:</b>		
2C180N	2C	180 L/min (48 USgpm)
33C85N	33C	85 L/min (22.6 USgpm)
33C170N	33C	170 L/min (45 USgpm)
<b>For KBDG5V-8 valves:</b>		
2C330N	2C	330 L/min (88 USgpm)
33C330N	33C	330 L/min (88 USgpm)
<b>For KBDG5V-10 valves:</b>		
2C550N	2C	550 L/min (145 USgpm)
7C550N	7C	550 L/min (145 USgpm)
12C550N	12C	550 L/min (145 USgpm)
33C550N	33C	550 L/min (145 USgpm)

### Asymmetric Spools

Figure preceding metering type designator, "N" (e.g. 2C\*\*\*N) is flow rating P-A, or A-T ("A" port flow); figure after "N" (N\*\*\*) is flow rating P-B, or B-T ("B" port flow).

SPOOL CODE	MAIN STAGE SPOOL SYMBOL	FLOW RATING
<b>For KBDG5V-5 valves:</b>		
2C70N45	2C	70 L/min (18.6 USgpm), "A" port flow 45 L/min (12.0 USgpm), "B" port flow
33C60N40	33C	60 L/min (16.0 USgpm), "A" port flow 40 L/min (10.6 USgpm), "B" port flow
<b>For KBDG5V-7 valves:</b>		
2C180N100	2C	180 L/min (48.0 USgpm), "A" port flow 100 L/min (26.6 USgpm), "B" port flow
33C130N65	33C	130 L/min (34.6 USgpm), "A" port flow 65 L/min (17.3 USgpm), "B" port flow
<b>For KBDG5V-8 valves:</b>		
2C330N200	2C	330 L/min (88.0 USgpm), "A" port flow 250 L/min (66.6 USgpm), "B" port flow
33C330N200	33C	330 L/min (88.0 USgpm), "A" port flow 250 L/min (66.6 USgpm), "B" port flow
133C330N200	133C	330 L/min (88.0 USgpm), "A" port flow 250 L/min (66.6 USgpm), "B" port flow
12C330N200	12C	330 L/min (88.0 USgpm), "A" port flow 250 L/min (66.6 USgpm), "B" port flow
<b>For KBDG5V-10 valves:</b>		
2C310N550	2C	310 L/min (82.6 USgpm), "A" port flow 550 L/min (145 USgpm), "B" port flow
2C550N310	2C	550 L/min (145 USgpm), "A" port flow 310 L/min (82.6 USgpm), "B" port flow
33C310N550	33C	310 L/min (82.6 USgpm), "A" port flow 550 L/min (145 USgpm), "B" port flow
33C550N310	33C	550 L/min (145 USgpm), "A" port flow 310 L/min (82.6 USgpm), "B" port flow

# Functional Symbols

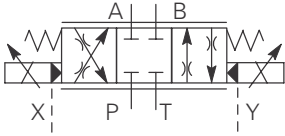

Simplified symbol  
KBDG5V models  
(Spool type "2" shown)

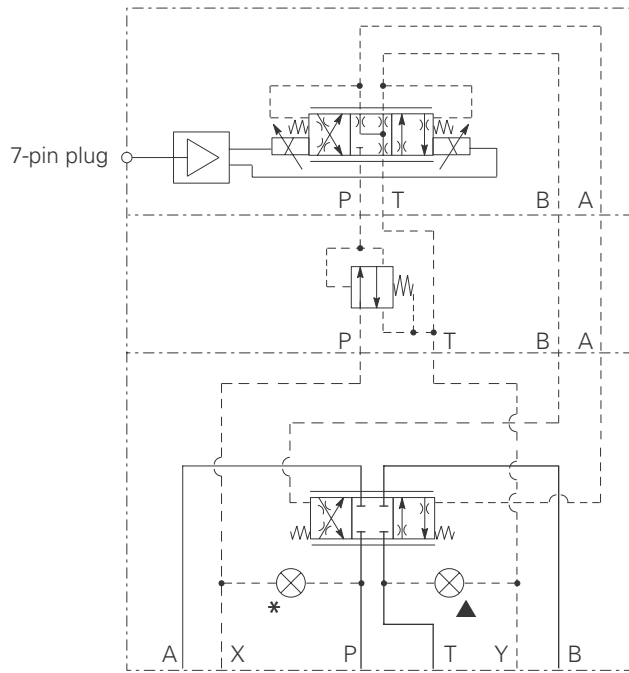

Pilot stage with integral amplifier.

Pressure reducer module, see "Model Code".

Main-stage.  
Spool type "2C" shown.

**Typical schematic symbol**

\* Internal plug shown, for external pilot supply (via port X). For internal pilot supply (from port P) plug is not fitted. Port X should be blocked at mounting interface, or otherwise plugged at subplate or manifold block. See "Model Code".

▲ Internal plug shown, for external pilot drain (via port Y). For internal pilot drain (via port T) plug is not fitted. Port Y should be blocked at mounting interface, or otherwise plugged at subplate or manifold block. See "Model Code".  
See also "Pilot Drain Application" notes.

# Operating Data

Data is typical with fluid at 36 cSt (168 SUS) and 50°C (122°F).

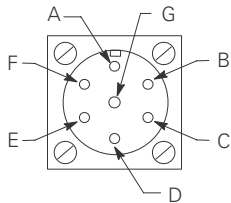
Power supply (24V)	(Model code <b>13</b> H)	24V DC (21V to 36V including 10% peak-to-peak ripple) maximum current - 1.2A
Command signal (Volts)		0 to +10V DC, or 0 to -10V DC, or -10V to +10V DC
Input impedance		47 kΩ
Common mode voltage to pin B	(Model code <b>11</b> 1)	4V
Command signal (Current)		4 to 20 mA
Input impedance	(Model code <b>11</b> 2)	100Ω
Valve enable signal:		
Enable		>9.0V (36V max)
Disable		<2.0V
Input impedance		36 kΩ
7-pin plug connector		Pin Description
		
		A Power supply positive (+)
		B Power supply 0V and current command return
		C Valve enable (PH7 & PR7)
		D Command signal (+V or current in)
		E Command signal (-V or current GND)
		F Output monitor
		G Protective ground
View of pins of fixed half		
Electromagnetic compatibility (EMC):		
Emission (10 V/m)		EN 50081-2
Immunity (10 V/m)		EN 50082-2
Monitor signal (pin F)		0 to +5V (0.39 V/A)
Output impedance		10 kΩ
Reproducibility, valve-to-valve (at factory settings):		
Flow at 100% command signal		≤5%
Protection:		
Electrical		Reverse polarity protected
Environmental		IEC 529, Class IP67
Ambient air temperature range for full performance		0°C to 70°C (32°F to 158°F)
Oil temperature range for full performance		0°C to 70°C (32°F to 158°F)
Minimum temperature at which valves will work at reduced performance		-20°C (-4°F)
Storage temperature range		-25°C to +85°C (-13°F to +185°F)
Mass:		
Valves with integral pressure reducing module		
KBDG5V-5		9,8 kg (21.2 lb)
KBDG5V-7		11,9 kg (25.8 lb)
KBDG5V-8		20,6 kg (44.6 lb)
KBDG5V-10		54,9 kg (118.9 lb)
For models without reducing module, deduct 1,2 kg (2.6 lb)		
Supporting products:		
Auxiliary electronic modules (DIN-rail mounting):		
EHA-CON-201-A-2* Signal converter		See catalog 2410A
EHD-DSG-201-A-1* Command signal generator		See catalog 2470
EHA-RMP-201-A-2* Ramp generator		See catalog 2410A
EHA-PID-201-A-2* PID controller		See catalog 2427
EHA-PSU-201-A-10 Power supply		See catalog 2410A
Ramp time		0-12 sec for full step input (0-100%)
Relative duty factor		Continuous rating (ED = 100%)
Hysteresis with flow through P-A-B-T		<8% of rated flow

# Performance Characteristics

Data is typical with fluid at 36 cSt (168 SUS) and 50°C (122°F).

## Minimum Pressure

KBDG5V-5/7/8

For full flow performance, pilot pressure  $\geq 45$  bar (650 psi).

KBDG5V-10

For full flow performance, pilot pressure  $\geq 28$  bar (405 psi).

i.e.

Pressure at port P for internal pilot supply.

or

Pressure at port X for external pilot supply.

## Pilot Drain Application Notes

External pilot drain is the recommended configuration.

Internal pilot drain is possible where a stable "T" port pressure, not exceeding 8 bar (116 psi), can be guaranteed.



Any pressure surges at the "T" port (drain) will cause the main spool to move and change the valve output. This possibility is eliminated by the use of an external drain.

## Maximum Pressures, bar (psi) For models without integral pilot pressure reducer

MODEL	PILOT PRESSURE SOURCE	MODEL CODE 7	PORTS P, A, B	T	X	Y †
KBDG5V-5	External	E	315 (4500)	210 (3000)	200 (2900)	8 (116)
	Internal	Omit	200§ (2900)	210 (3000)	■	8 (116)
KBDG5V-7/8	External	E	350 (5000)	350 (5000)	200 (2900)	8 (116)
	Internal	Omit	200§ (2900)	350 (5000)	■	8 (116)
KBDG5V-10	External	E	350 (5000)	350 (5000)	40 (580)	8 (116)
	Internal	Omit	40 (580)	350◆ (5000)	■	8 (116)

## For models with integral pilot pressure reducer

KBDG5V-5	External	EX	315 (4500)	210 (3000)	315 (4500)	8 (116)
	Internal	X	315 (4500)	210 (3000)	■	8 (116)
KBDG5V-7/8	External	EX	350♣ (5000)	350♣ (5000)	315 (4500)	8 (116)
	Internal	X	350 (5000)	350♣ (5000)	■	8 (116)
KBDG5V-10	External	EX	350 (5000)	350◆ (5000)	315 (4500)	8 (116)
	Internal	X	350 (5000)	350◆ (5000)	■	8 (116)

■ When using internal pilot pressure, port X should be plugged at the subplate or manifold face (e.g. manifold not drilled for connection to port X).

§ The maximum pressure for ports A and B is: 310 bar (4500 psi) for size 5; 350 bar (5000 psi) for sizes 7 and 8.

† See "Pilot Drain Application" note.

◆ Pilot must be externally drained, otherwise "Y" port pressure applies.

♣ Pilot must be externally drained, otherwise "T" port pressure limited to 210 bar (3000 psi).



# Power Capacity Envelopes

Flow through P-A-B-T or P-B-A-T

## Power Capacity Looped Flow

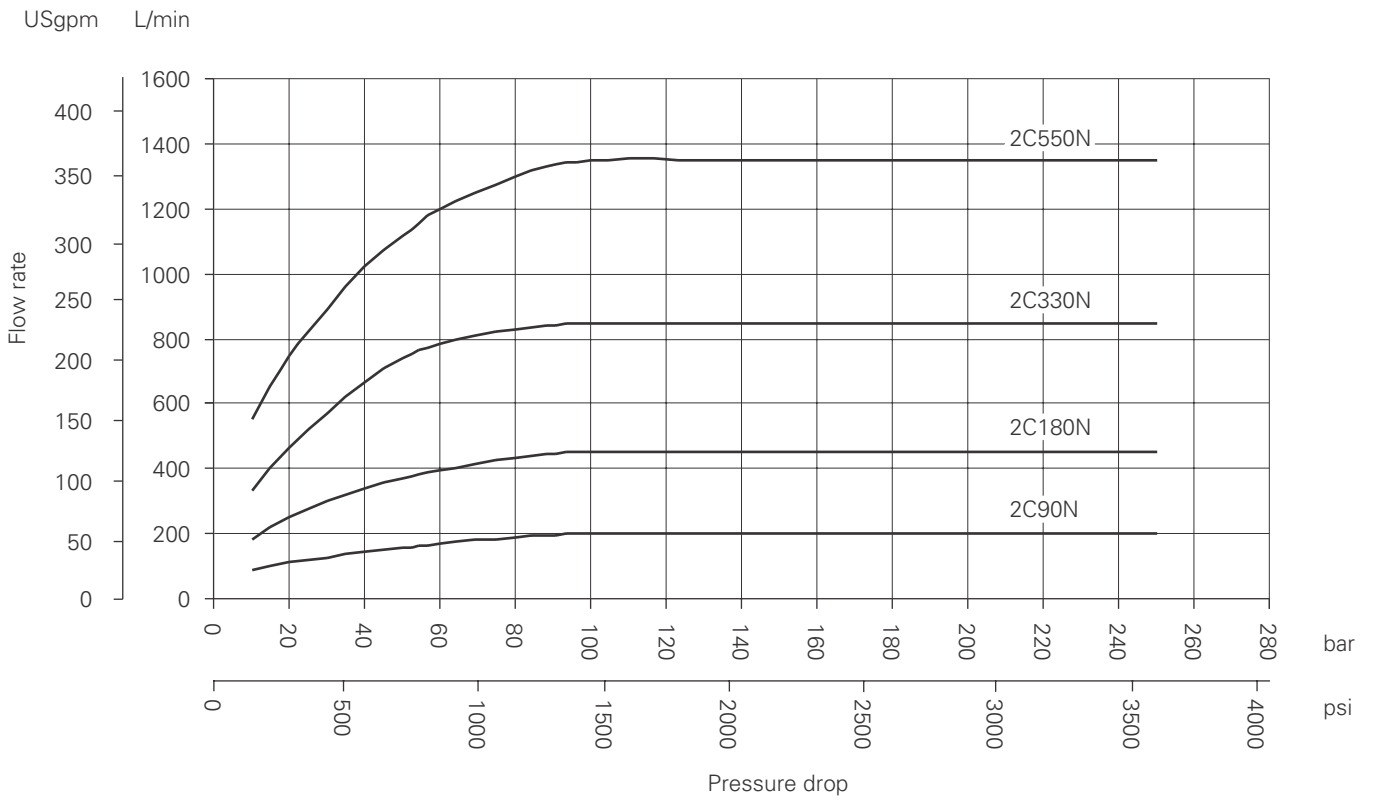
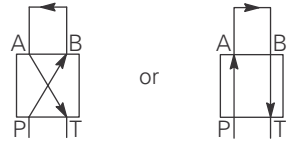

# Flow Characteristics

Flow gain curves at stated values of total valve pressure drop, for flow P-A-B-T, or P-B-A-T.

**KBDG5V-5-2C90N**

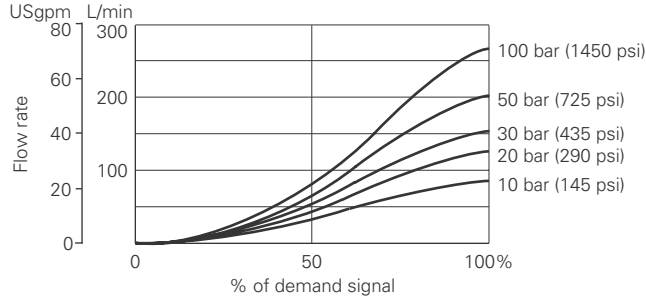

**KBDG5V-5-33C80N**

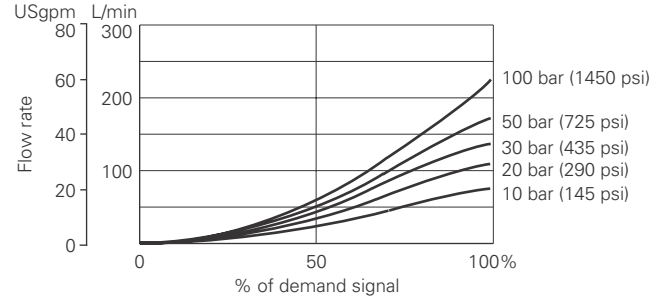

**KBDG5V-7-2C180N**

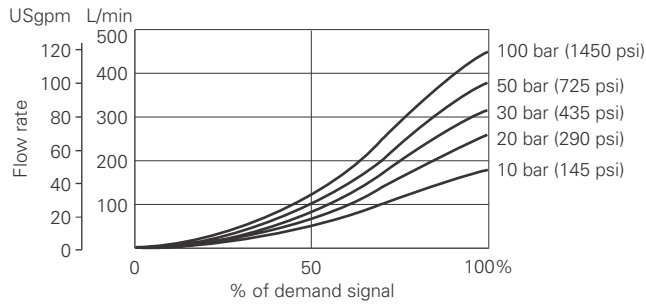

**KBDG5V-7-33C85N**

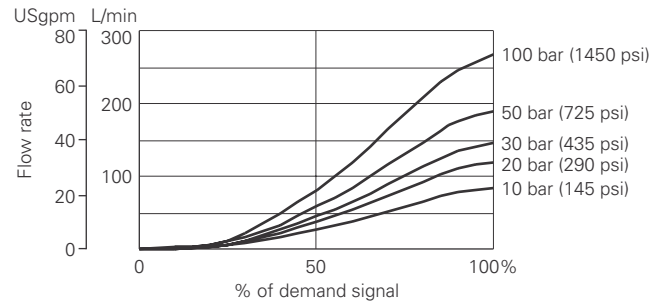

**KBDG5V-7-33C170N**

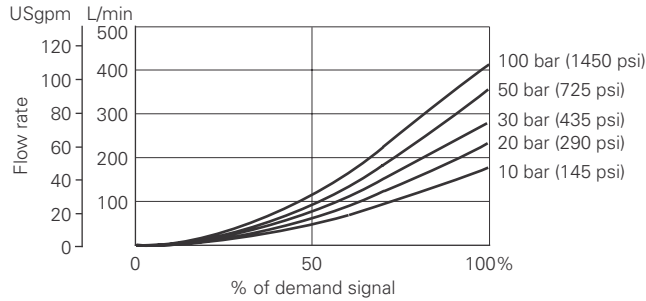

**KBDG5V-8-2C330N**

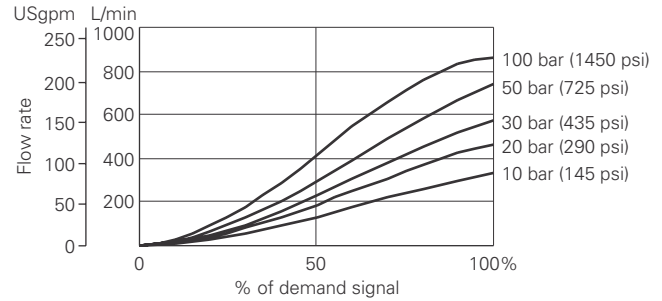

**KBDG5V-8-33C330N**

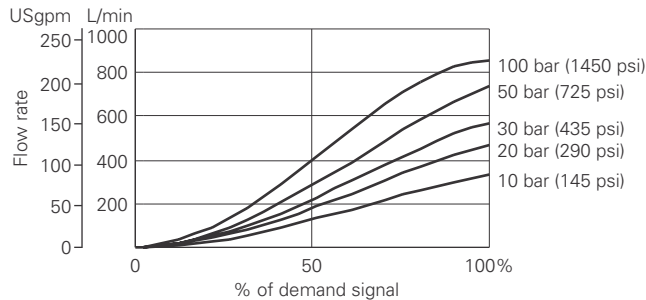

# Flow Characteristics (continued)

Flow gain curves at 10 bar (145 psi) valve pressure drop, for flow P-A-B-T, or P-B-A-T.

**KBDG5V-10-2C550N**

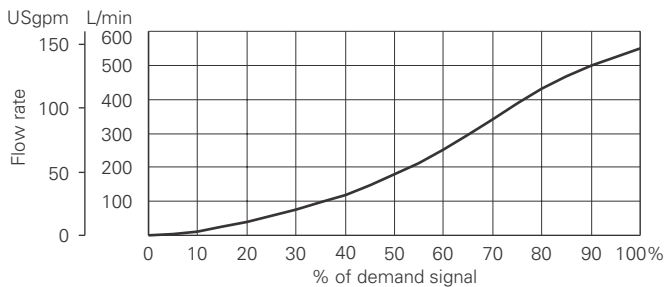

**KBDG5V-10-7C550N**  
**KBDG5V-10-12C550N**

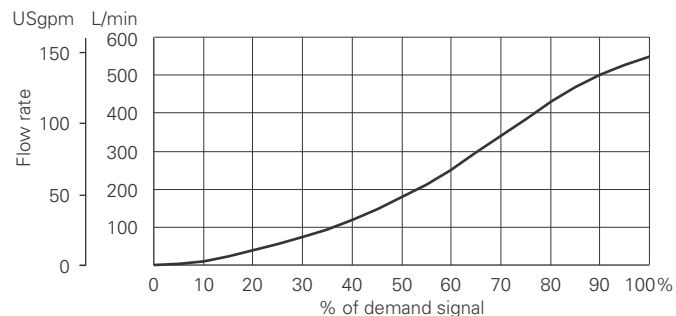

**KBDG5V-10-33C550N**

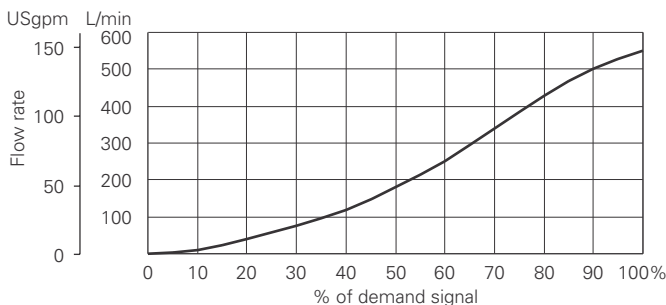

## Asymmetric Spools

At 5 bar (72 psi) valve pressure drop

**KBDG5V-10-33C550N310**

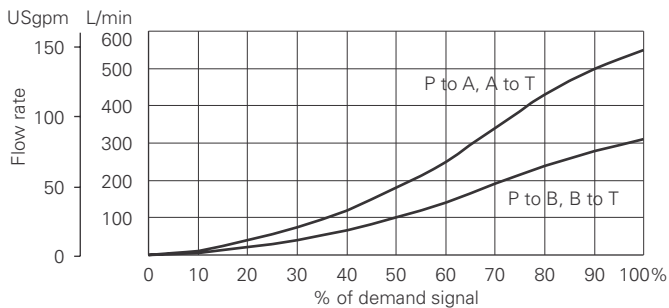

# Step Response (Typical)

Test conditions:  
 No pressure reducer module  
 Flow P-A-B-T  
 Total valve  $\Delta p = 10$  bar  
 (145 psi)  
 External pilot pressure = 50 bar  
 (725 psi)  
 "Response" = Time, from step response signal, until output reaches 90% of step change value

INPUT SIGNAL STEP CHANGE	SPOOL RESPONSE TIMES (ms)			
	KBDG5V-5	KBDG5V-7	KBDG5V-8	KBDG5V-10
0 to 100%	42	45	85	110
100% to 0	33	47	55	110
10% to 90%	43	58	75	100
90% to 10%	40	50	54	100
25% to 75%	34	50	70	95
75% to 25%	30	48	45	95
90% to 90%	78	78	144	200

Pilot flow required to achieve above response times:

KBDG5V-5	KBDG5V-7	KBDG5V-8	KBDG5V-10
3,8 L/min	6,2 L/min	6,2 L/min	23,0 L/min
(0.98 USgpm)	(1.6 USgpm)	(1.6 USgpm)	(5.96 USgpm)

# Installation Dimensions

## KBDG5V Models with "EX" or "X"

(With integral pilot pressure reducer)  
The illustration is correct for KBDG5V-8 valves  
Dimensions are shown in mm (inches)

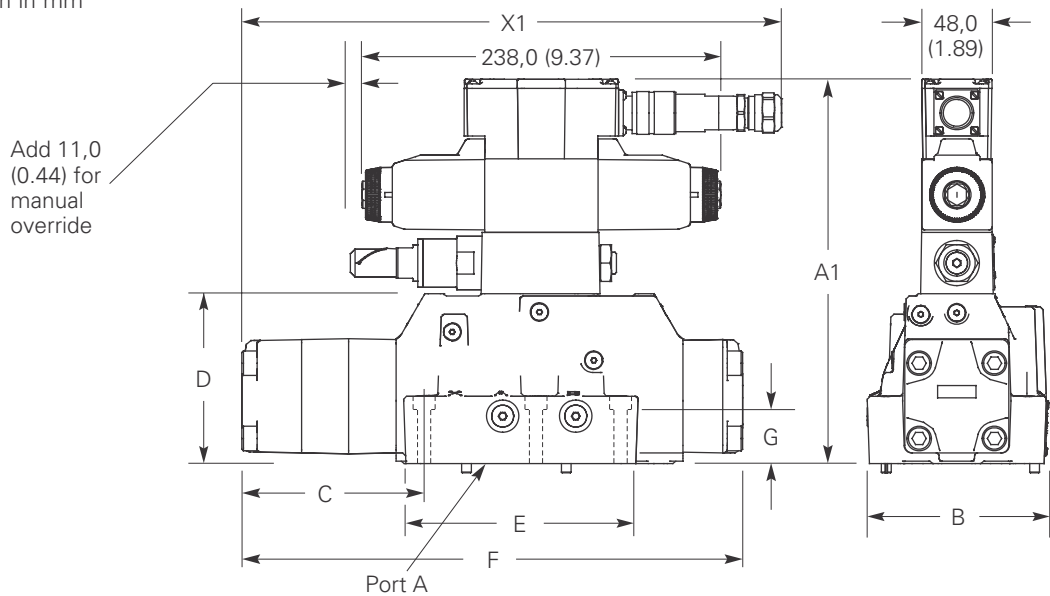

## KBDG5V Models with "E" or No Symbol

(Without integral pilot pressure reducer)

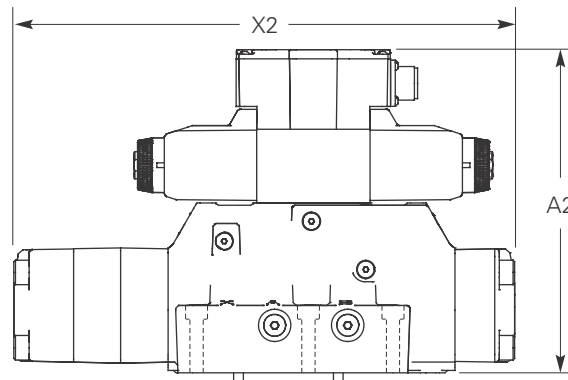

MODEL	A1	A2	B	C	D	E	F	G	X1▲	X2▲
KBDG5V-5	233,6 (9.20)	187,6 (7.39)	70,4 (2.77)	94,4 (3.72)	87,3 (3.4)	98,0 (3.86)	217,0 (8.54)	30,0 (1.18)	277,0 (10.9)	238,0 (9.37)
KBDG5V-7	241,4 (9.50)	195,4 (7.69)	92,8 (3.65)	83,3 (3.3)	95,1 (3.7)	124,0 (4.88)	232,0 (9.14)	33,0 (1.3)	297,0 (11.69)	258,0 (10.15)
KBDG5V-8	257,3 (10.13)	211,3 (8.32)	117,0 (4.60)	117,3 (4.62)	111,0 (4.37)	175,5 (6.91)	327,0 (12.87)	42,5 (1.67)	352,0 (13.86)	327,0 (12.87)
KBDG5V-10	339,8 (13.38)	293,8 (11.57)	196,8 (7.75)	194,3 (7.65)	193,5 (7.62)	226,8 (8.93)	516,9 (20.35)	35,0 (1.38)	516,9 (20.35)	516,9 (20.35)

▲ Overall installed length of KBD valves is X1 with connector fitted, and X2 without.

## Pilot Supply and Drain Plugs

### KBDG5V-5 models

Viewed from port B end of main-stage

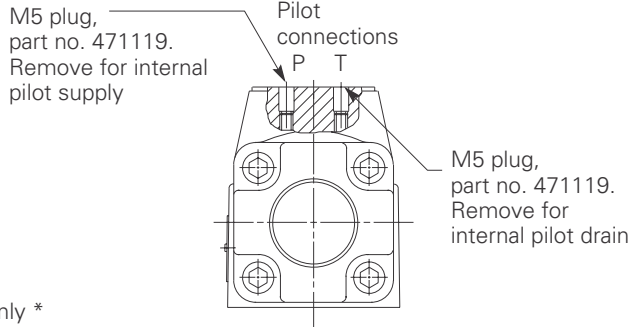

### KBDG5V-7 models only \*

Remove this plug for access to pilot drain plug

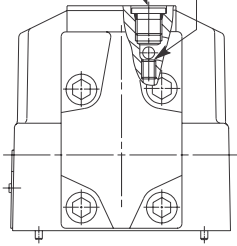

### KBDG5V-7 models only \*

M6 x 8 mm plug, part no. 471131: fitted for external pilot drain. Not fitted for internal pilot drain.

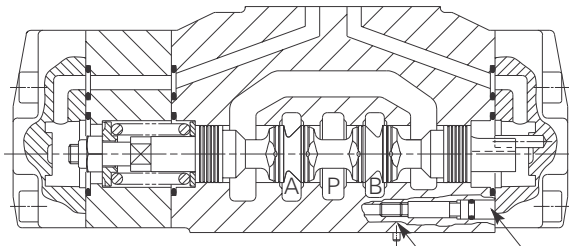

### KBDG5V-7 models only \*

M6 x 8 mm plug, part no. 471131: fitted for external pilot supply models; not fitted for internal pilot supply models. See "Model Code" .

### Size 7 only \*

M5 internal thread for removal of closure plug

\* Internal plug shown, for external pilot supply (via port X).

For internal pilot supply (from port P) plug is not fitted. Port X should be blocked at mounting interface, or otherwise plugged at subplate of manifold block. See "Model Code" .

### KBDG5V-8 models

Section through port P of main-stage

M5 plug, part no. 471119. Remove for internal pilot drain

1/16" NPT plug, part no. 113000. Remove for internal pilot supply

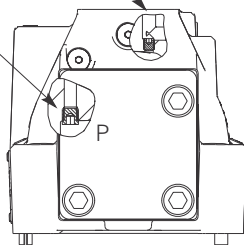

### KBDG5V-10 models

Plug, part no. 7074. Remove for internal pilot drain

Plug, part no. 30560 for internal pilot drain, part no. 7074 for external pilot drain.

Plug, part no. 30560. Remove for internal pilot drain

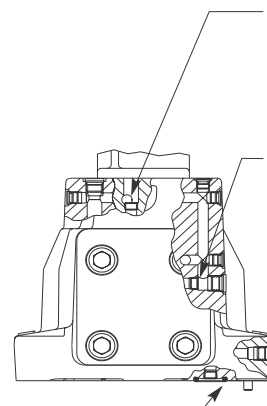

## Views on Mounting Faces

All O-seals supplied

**KBDG5V-5**

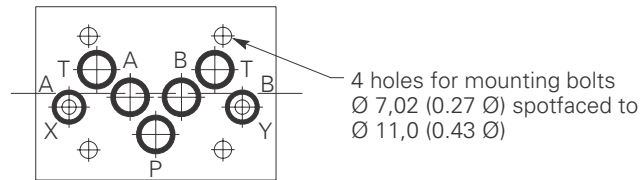

**KBDG5V-7**

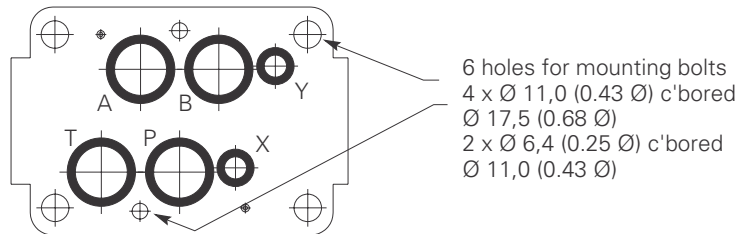

**KBDG5V-8**

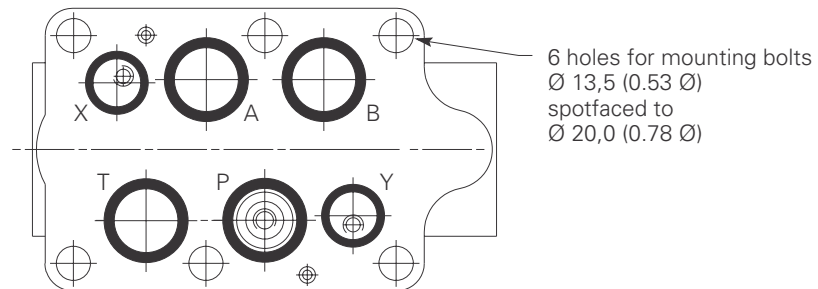

**KBDG5V-10**

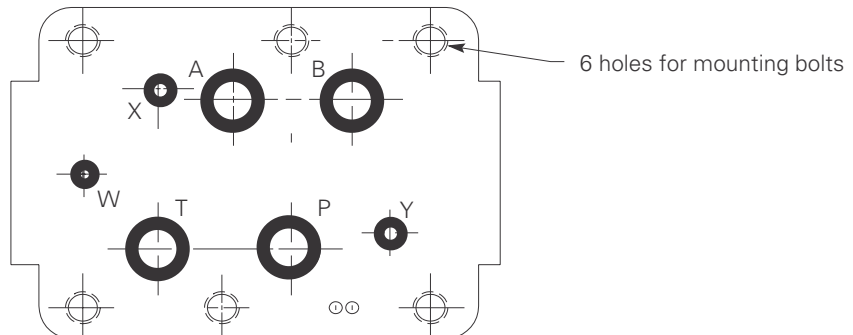

## Block Diagram KBDG5V-\*

### COMMAND SIGNALS AND OUTPUTS

7-pin plug		Flow direction		
Command = Volts ( $\pm 10V$ )	<b>Pin D</b>	<b>Pin E</b>	P to A	
	Positive	0V		
	0V	Negative	P to B	
	$V_D - V_E = \text{Positive}$			
	Negative	0V		
0V	Positive	P to B		
$V_D - V_E = \text{Negative}$				
Command = Current (4-20 mA)	<b>Pin D</b>	<b>Pin E</b>	<b>Pin B</b>	<b>Flow direction</b>
	More than 12 mA	Current GND	Current return	P to A
	Less than 12 mA	Current GND	Current return	P to B

### Wiring

Connections must be made via the 7-pin plug mounted on the amplifier. See this leaflet and Installation Wiring Practices for Vickers™ Electronic Products leaflet 2468. Recommended cable sizes are:

### Power Cables

For 24V supply:  
0,75 mm<sup>2</sup> (18 AWG) up to 20m (65 ft)  
1,00 mm<sup>2</sup> (16 AWG) up to 40m (130 ft)

### Signal Cables

0,50 mm<sup>2</sup> (20 AWG)

### Screen (Shield)

A suitable cable would have 7 cores, a separate screen for the signal wires and an overall screen. Cable outside diameter 8,0-10,5 mm (0.31- 0.41 inches). See connection diagrams on next page.

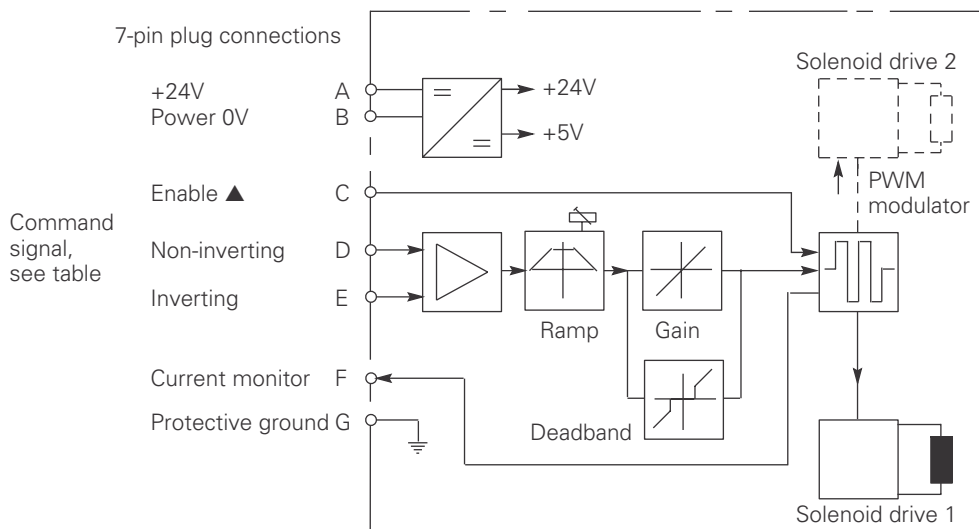

▲ In valves with PH7 or PR7 type electrical connection.



### Warning

All power must be switched off before connecting or disconnecting any plugs.



## Typical Connection Arrangements

### Wiring Connections

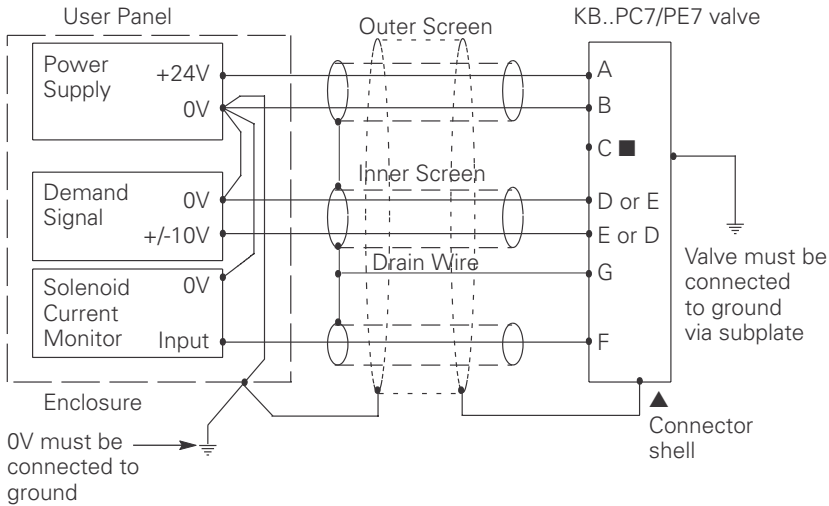

■ Pin C may be connected to ground or left unconnected.

### Wiring Connections for Valves with "Enable" Feature

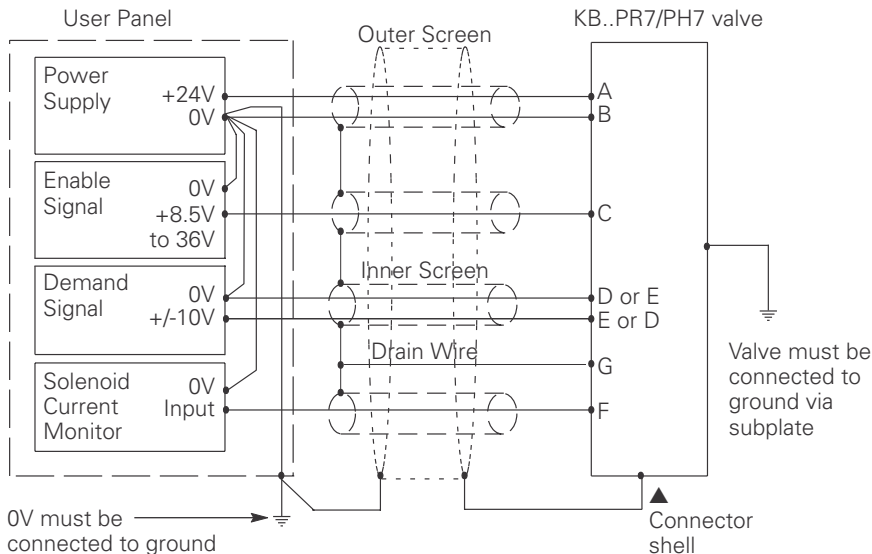

▲ Note:

In applications where the valve must conform to European RFI/EMC regulations, the outer screen (shield) must be connected to the outer shell of the 7-pin connector, and the valve body must be fastened to the earth ground. Proper earth grounding practices must be observed in this case, as any differences in command source and valve ground potentials will result in a screen (shield) ground loop.



#### Warning

Electromagnetic Compatibility (EMC)

It is necessary to ensure that the valve is wired up as above. For effective protection the user electrical cabinet, the valve subplate or manifold and

the cable screens should be connected to efficient ground points. The metal 7-pin connector part no. 934939 should be used for the integral amplifier.

In all cases both valve and cable should be kept as far away as possible from any

sources of electromagnetic radiation such as cables carrying heavy current, relays and certain kinds of portable radio transmitters, etc. Difficult environments could mean that extra screening may be necessary to avoid the interference.

It is important to connect the 0V lines as shown above. The multi-core cable should have at least two screens to separate the demand signal and monitor output from the power lines.

The enable line to pin C should be outside the screen which contains the demand signal cables.

# Application Data

## Fluid Cleanliness

Proper fluid condition is essential for long and satisfactory life of hydraulic components and systems. Hydraulic fluid must have the correct balance of cleanliness, materials and additives for protection against wear of components, elevated viscosity and inclusion of air.

Recommendations on contamination control methods and the selection of products to control fluid condition are included in publication 9132 or 561, "Guide to Systemic Contamination Control". The book also includes information on the concept of "ProActive Maintenance". The following recommendations are based on ISO cleanliness levels at 2 µm, 5 µm and 15 µm.

For products in this catalog the recommended levels are:  
0 to 70 bar (1000 psi)...18/16/13  
70+ bar (1000+ psi)...17/15/12

Vickers™ products, as any components, will operate with apparent satisfaction in fluids with higher cleanliness codes than those described. Other manufacturers will often recommend levels above those specified.

Experience has shown, however, that life of any hydraulic components is shortened in fluids with higher cleanliness codes than those listed above. These codes have

been proven to provide a long trouble-free service life for the products shown, regardless of the manufacturer.

## Hydraulic Fluids

Materials and seals used in these valves are compatible with antiwear hydraulic oils, and with non-alkyl-based phosphate esters.

The extreme operating viscosity range is 500 to 13 cSt (2270 to 70 SUS) but the recommended running range is 54 to 13 cSt (245 to 70 SUS).

## Installation

The proportional valves in this catalog can be mounted in any attitude, but it may be necessary in certain demanding applications, to ensure that the solenoids are kept full of hydraulic fluid. Good installation practice dictates that the tank port and any drain port are piped so as to keep the valves full of fluid once the system start-up has been completed.

## Mounting Bolt Kits

**For KBDG5V-5**  
BK02-156493M (metric)  
BK590720 (inch)

**For KBDG5V-7**  
BKDG7M (metric)  
BK590724 (inch)

**For KBDG5V-8**  
BKDG8-655M (metric)  
BKDG06-635 (inch)

**For KBDG5V-10**  
BKDG10636M (metric)  
BKDG10636 (inch)

If not using recommended Vickers™ bolt kits, bolts used should be to ISO 898, 12.9 or better.

## Mounting Bolt Torques

Recommended torques with threads lubricated

**For KBDG5V-5**  
M6 or 1/4"-20 UNC bolts:  
To 210 bar (3000 psi) 14 Nm (10.3 lbf ft)  
To 310 bar (4500 psi) 20 Nm (14.75 lbf ft)

**For KBDG5V-7**  
M10 or 3/8"-16 UNC bolts:  
49 to 59 Nm (36 to 43 lbf ft) plus  
M6 or 1/4"-20 UNC bolts  
9 to 14 Nm (6.6 to 10.3 lbf ft)

**For KBDG5V-8**  
M12 or 1/2"-13 UNC bolts  
103 to 127 Nm (76 to 93 lbf ft)

**For KBDG5V-10**  
M20 or 3/4"-10 UNC-2B bolts  
185-220 Nm (250-300 lbf ft)

## Seal Kits (Mainstage Only)

KBDG5V-5.....565143  
KBDG5V-7.....02-351175  
KBDG5V-8.....02-352520  
KBDG5V-10.....02-329888

## Plugs

7-pin plug (metal) 934939  
7-pin plug (plastic) 694534  
(Metal plug must be used for full EMC protection)

**Note:** An alternative metal connector which gives EMC protection but not IP67 rating is available from ITT-Cannon, part number CA06-COM-E-14S-A7-P.

## Service Information

The products from this range are preset at the factory for optimum performance; disassembling critical items would destroy these settings. It is recommended that if any mechanical or electronic repair is necessary, valves should be returned to the nearest Eaton Hydraulics repair center. The products will be refurbished as necessary and retested to specification before return.

Field repair is restricted to the replacement of the seals.

**Eaton**  
14615 Lone Oak Road  
Eden Prairie, MN 55344-2287  
USA  
Tel: (+1) 952 937-9800  
Fax: (+1) 952 974-7722  
[www.hydraulics.eaton.com](http://www.hydraulics.eaton.com)

**Eaton**  
20 Rosamond Road  
Footscray  
Victoria 3011  
Australia  
Tel: (+61) 3 9319 8222  
Fax: (+61) 3 9318 5714

**Eaton**  
46 New Lane, Havant  
Hampshire PO9 2NB  
England  
Tel: (+44) 23 9248 6451  
Fax: (+44) 23 9248 7110

**EAT•N**

**Vickers**

© 2003 Eaton Corporation  
All Rights Reserved  
Printed in USA  
Document No. V-VLPO-MC001-E  
January 2003