

General Description

Series D41VW valves are piloted by a D1VW valve. The valves can be ordered with position control.

The minimum pilot pressure must be ensured for all operating conditions of the directional valve.

Additionally spools with a P to T connection in the de-energized position need an external pressure supply (external inlet) or an integral check valve.

Features

- **World design** – Available worldwide.
- **Mounting bolts below center line of spool** – Minimizes spool binding.
- **Five chamber style** – Eliminates pressure spikes in tubes, increasing valve life.
- **High pressure and flow ratings** – Increased performance options in a compact valve.

Dimensions

Inch equivalents for millimeter dimensions are shown in (**)

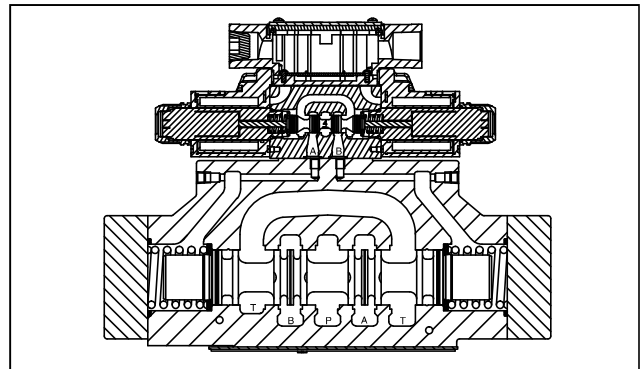
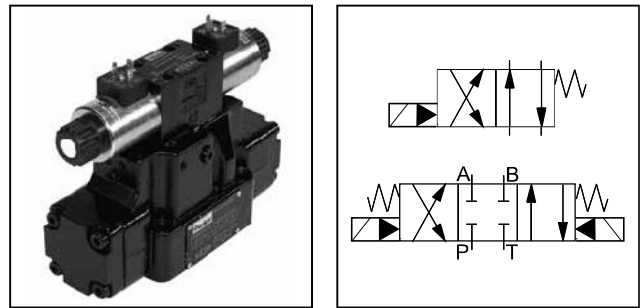

A

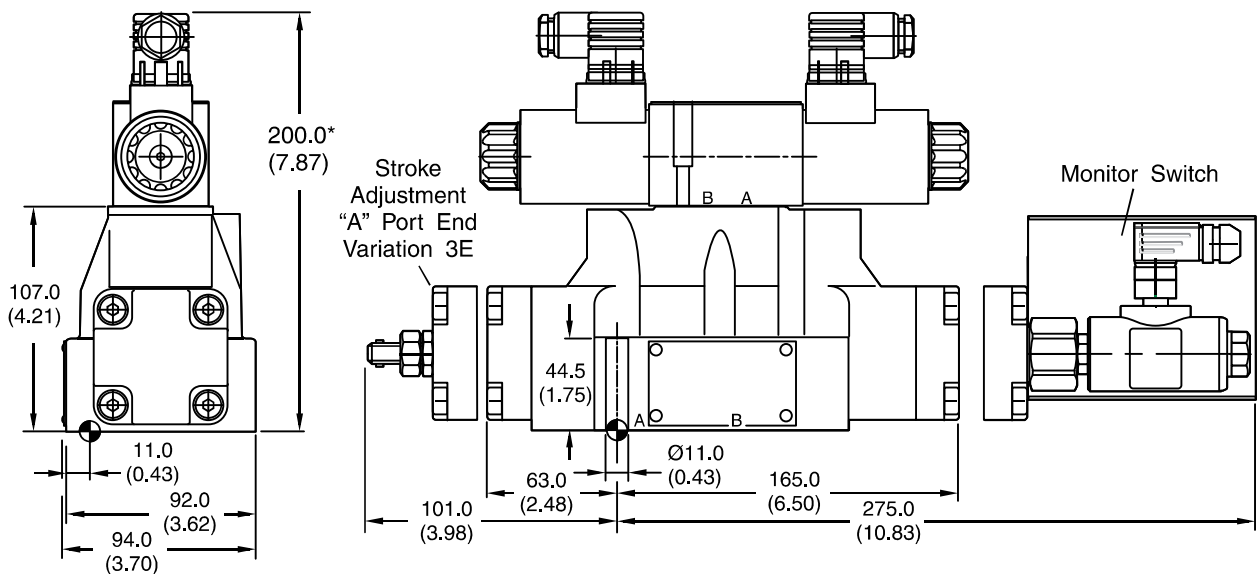

* Please add for each sandwich plate +40mm (1.58") (pressure reducing valve, pilot choke valve meter-in/-out).

Surface Finish	Kit	Kit	Kit	Seal Kit
$\sqrt{R_{max} 6.3}$ $\square 0.01/100$	BK320	4x M10x60 2x M6x55 DIN 912 12.9	63 Nm (46.5 lb.-ft.) 13.2 Nm (9.7 lb.-ft.) ±15%	Nitrile: SK-D41VW-N-91 Fluorocarbon: SK-D41VW-V-91

The space necessary to remove the plug per DIN 43650, design type AF is at least 15 mm.

The torque for the screw M3 of the plug has to be 0.5 to 0.6 Nm.

A

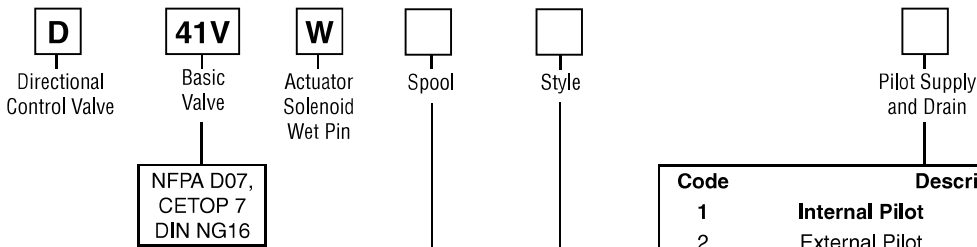

NFPA D07,
 CETOP 7
 DIN NG16

Code	Description	
1	Internal Pilot	External Drain
2	External Pilot	External Drain
3	Internal Pilot w/ Check	Internal Drain
4	Internal Pilot	Internal Drain
5	External Pilot	Internal Drain
6	Internal Pilot w/ Check	Internal Drain

* Not available with 002, 007, 009, 054 spools.

3-Position Spools	
Code	Spool Type
	a 0 b
001	
002	
003	
004	
005	
006	
007	
009	
011	
014	
015	
016	
021	
022	
054	
081	
082	

2-Position Spools	
Code	Spool Type
	a b
020	
026	
030	

3-Position Spools		
Code	All 3-Position Spools	
C		3 positions. Spring offset in position "0". Operated in position "a" or "b".
	Standard	Spool Type 009
E	 Operated in position "a".	 Operated in position "b".
F	 Spring offset in position "b".	 Spring offset in position "a".
K	 Operated in position "b".	 Operated in position "a".
M	 Spring offset in position "a".	 Spring offset in position "b".
R	 No center in offset position.	 No center in offset position.
S	 No center in offset position.	 No center in offset position.

2-Position Spools		
Code	Spool Position	
B		Spring offset in position "b". Operated in position "a".
D		Detent, operated in position "a" or "b". No center or offset position.
H		Spring offset in position "a". Operated in position "b".

Weight:
 Single Solenoid: 9.7 kg (21.4 lbs.)
 Double Solenoid: 10.3 kg (22.7 lbs.)

Bold: Designates Tier I products and options.

Non-Bold: Designates Tier II products and options. These products will have longer lead times.

D41.indd, dd



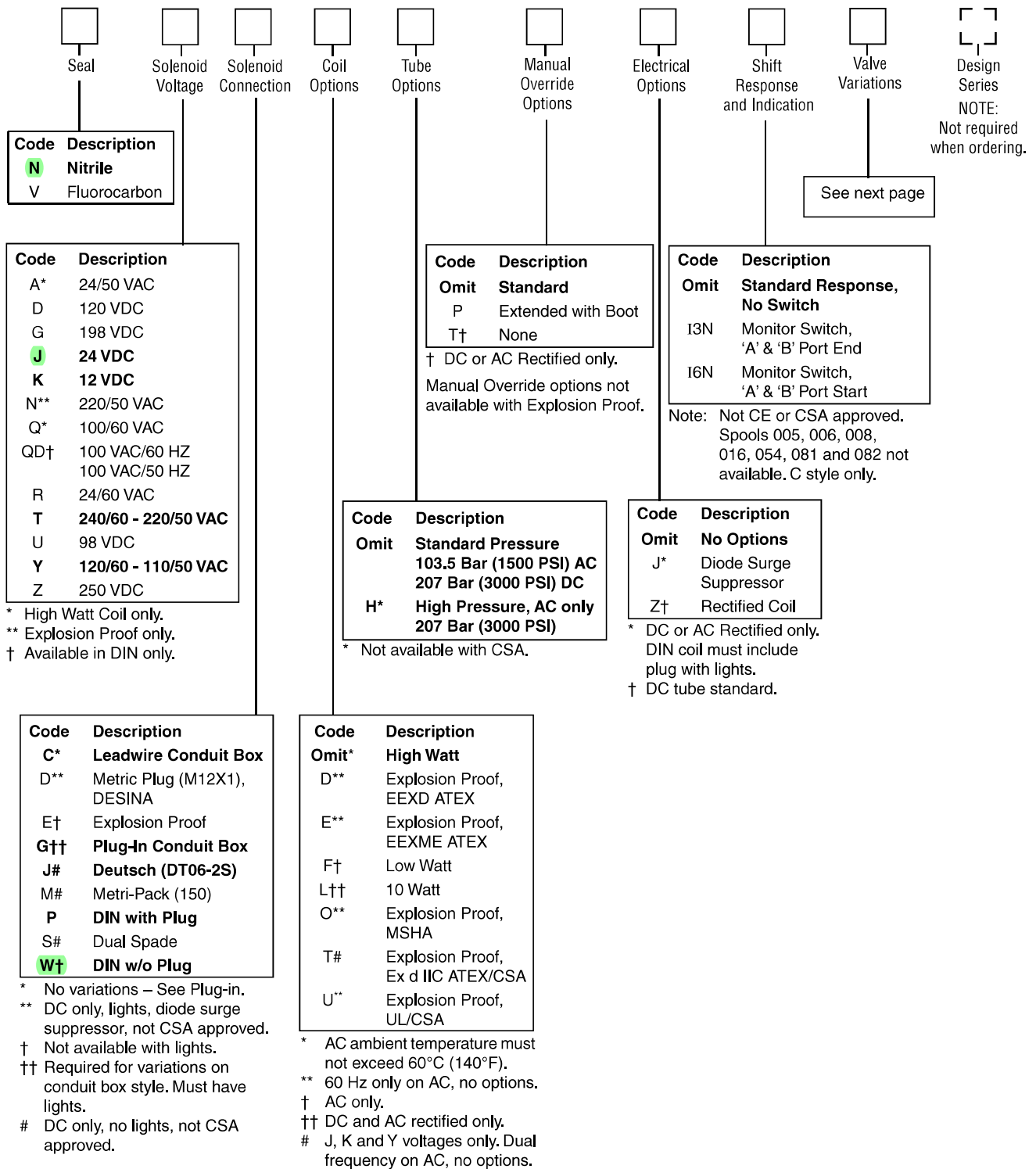

Bold: Designates Tier I products and options.

Non-Bold: Designates Tier II products and options. These products will have longer lead times.

D41.indd, dd



Valve Variations

A

Code	Description
5*	Signal Lights – Standard
	Signal Lights – Hirsch. (DIN with Plug)
7B**	Manaplug – Brad Harrison (12x1) Micro with Lights
56**	Manaplug (Mini) with Lights
1C**	Manaplug (Mini) Single Sol. 5-pin, with Lights
1D**	Manaplug (Micro) Single Sol. 5-pin, with Lights
1G**	Manaplug (Mini) Single Sol. 5-pin, with Stroke Adjust 'A' & 'B' End and Lights
1H**	Manaplug (Micro) Single Sol. 5-pin, with Stroke Adjust 'A' & 'B' End and Lights
1M**	Manaplug Opposite Normal
1R	Stroke Adjust 'A' & 'B' End with Pilot Choke Meter In
3A	Pilot Choke Meter Out
3B	Pilot Choke Meter In
3C	Pilot Pressure Reducer
3D	Stroke Adjust 'B' End
3E	Stroke Adjust 'A' End
3F	Stroke Adjust 'A' & 'B' End
3G*	Pilot Choke Meter Out with Lights
3H*	Pilot Choke Meter In with Lights
3J*	Pilot Pressure Reducer with Lights
3K	Pilot Choke Meter Out with Stroke Adjust 'A' & 'B' End
3L**	Pilot Choke Meter Out, Stroke Adjust 'A' & 'B' End with Lights and Manaplug — Brad Harrison Mini
3M	Pilot Choke Meter Out, Pilot Pressure Reducer, Stroke Adjust 'A' & 'B' End
3R	Pilot Choke Meter Out & Pilot Pressure Reducer
3S**	Lights and 5-pin Mini Manaplug with Pilot Choke
7Y**	M12x1 Manaplug (4-pin), Special Wiring, and Lights

* DESINA, plug-in conduit box, and DIN with plug styles only.

** Must have plug-in style conduit box.

Bold: Designates Tier I products and options.

Non-bold: Designates Tier II products and options. These products will have longer lead times.

Solenoid Ratings

Insulation System	Class F
Allowable Deviation from rated voltage	-15% to +10% for DC and AC rectified coils -5% to +5% for AC Coils
Armature	Wet pin type
CSA File Number	LR60407
Environmental Capability	DC Solenoids meet NEMA 4 and IP67 when properly wired and installed. Contact HVD for AC coil applications.

Explosion Proof Solenoid Ratings*

U.L. & CSA (EU)	Class I, Div 1 & 2, Groups C & D Class II, Div 1 & 2, Groups E, F & G As defined by the N.E.C.
MSHA (EO)	Complies with 30CFR, Part 18
ATEX (ED)	Complies with ATEX requirements for: Exd, Group IIB; EN50014: 1999+ Amds. 1 & 2, EN50018: 2000
ATEX & CSA/US (ET)	Complies with ATEX EN60079-0, EN60079-1 Ex d IIC; CSA/US Ex d IIC, AEx d IIC for Class I, Zone 1, UL1203, UL1604, CSA E61241,1 Class II, Div 1



* Allowable Voltage Deviation ±10%.
 Note that Explosion Proof AC coils are single frequency only.

Code		Voltage	In Rush Amps Amperage	In Rush VA	Holding Amps @ 3MM	Watts	Resistance
Voltage Code	Power Code						
D	L	120 VDC	N/A	N/A	0.09 Amps	10 W	1584.00 ohms
D	Omit	120 VDC	N/A	N/A	0.26 Amps	30 W	528.00 ohms
G	Omit	198 VDC	N/A	N/A	0.15 Amps	30 W	1306.80 ohms
J	L	24 VDC	N/A	N/A	0.44 Amps	10 W	51.89 ohms
J	Omit	24 VDC	N/A	N/A	1.32 Amps	30 W	17.27 ohms
K	L	12 VDC	N/A	N/A	0.88 Amps	10 W	12.97 ohms
K	Omit	12 VDC	N/A	N/A	2.64 Amps	30 W	4.32 ohms
L	L	6 VDC	N/A	N/A	1.67 Amps	10 W	3.59 ohms
L	Omit	6 VDC	N/A	N/A	5.00 Amps	30 W	1.20 ohms
Q	Omit	100 VAC / 60 Hz	2.05 Amps	170 VA	0.77 Amps	30 W	19.24 ohms
QD	F	100 VAC / 60 Hz	1.35 Amps	135 VA	0.41 Amps	18 W	31.20 ohms
QD	F	100 VAC / 50 Hz	1.50 Amps	150 VA	0.57 Amps	24 W	31.20 ohms
R	F	24/60 VAC, Low Watt	6.67 Amps	160 VA	2.20 Amps	23 W	1.52 ohms
T	Omit	240/60 VAC	0.83 Amps	199 VA	0.30 Amps	30 W	120.40 ohms
T	Omit	220/50 VAC	0.87 Amps	191 VA	0.34 Amps	30 W	120.40 ohms
T	F	240/60 VAC, Low Watt	0.70 Amps	168 VA	0.22 Amps	21 W	145.00 ohms
T	F	220/50 VAC, Low Watt	0.75 Amps	165 VA	0.26 Amps	23 W	145.00 ohms
U	L	98 VDC	N/A	N/A	0.10 Amps	10 W	960.00 ohms
U	Omit	98 VDC	N/A	N/A	0.31 Amps	30W	288.00 ohms
Y	Omit	120/60 VAC	1.7 Amps	204 VA	0.60 Amps	30 W	28.20 ohms
Y	Omit	110/50 VAC	1.7 Amps	187 VA	0.68 Amps	30 W	28.20 ohms
Y	F	120/60 VAC, Low Watt	1.40 Amps	168 VA	0.42 Amps	21 W	36.50 ohms
Y	F	110/50 VAC, Low Watt	1.50 Amps	165 VA	0.50 Amps	23 W	36.50 ohms
Z	L	250 VDC	N/A	N/A	0.04 Amps	10 W	6875.00 ohms
Z	Omit	250 VDC	N/A	N/A	0.13 Amps	30 W	1889.64 ohms
Explosion Proof Solenoids							
R		24/60 VAC	7.63 Amps	183 VA	2.85 Amps	27 W	1.99 ohms
T		240/60 VAC	0.76 Amps	183 VA	0.29 Amps	27 W	1.34 ohms
N		220/50 VAC	0.77 Amps	169 VA	0.31 Amps	27 W	1.38 ohms
Y		120/60 VAC	1.60 Amps	192 VA	0.58 Amps	27 W	33.50 ohms
P		110/50 VAC	1.47 Amps	162 VA	0.57 Amps	27 W	34.70 ohms
K		12 VDC	N/A	N/A	2.75 Amps	33 W	4.36 ohms
J		24 VDC	N/A	N/A	1.38 Amps	33 W	17.33 ohms
"ET" Explosion Proof Solenoids							
K		12 VDC	N/A	N/A	1.00 Amps	12 W	12.00 ohms
J		24 VDC	N/A	N/A	1.00 Amps	13 W	44.30 ohms
Y		120/60-50 VAC	N/A	N/A	0.16 Amps	17 W	667.00 ohms

D41.indd, dd



A

General			
Design	Directional Spool Valve		
Actuation	Solenoid		
Size	NG16		
Mounting Interface	DIN 24340 A16 / ISO 4401 / NFPA D07 / CETOP RP 121-H		
Mounting Position	Unrestricted, preferably horizontal		
Ambient Temperature	[°C]	-25...+50; (-13°F...+122°F) (without inductive position control)	
	[°C]	0...+50; (+32°F...+122°F) (with inductive position control)	
MTTF _D Value	[years]	75	
Hydraulic			
Maximum Operating Pressure	Pilot drain internal: P, A, B, X 350 Bar (5075 PSI); T, Y 105 Bar (1523 PSI) Pilot drain external: P, A, B, T, X 350 Bar (5075 PSI); Y 105 Bar (1523 PSI) 10 Watt 207 Bar (3000 PSI)		
Fluid	Hydraulic oil in accordance with DIN 51524 / 51525		
Fluid Temperature	[°C]	-25 ... +70 (-13°F...+158°F)	
Viscosity Permitted	[cSt]/[mm ² /s]	2.8...400 (13...1854 SSU)	
	Recommended [cSt]/[mm ² /s]	30...80 (139...371 SSU)	
Filtration	ISO 4406 (1999); 18/16/13 (meet NAS 1638: 7)		
Flow Maximum	300 LPM (79.4 GPM)		
Leakage at 350 Bar (per flow path)	[ml/min]	up to 200 (0.05 GPM) (depending on spool)	
Operating Pressure	See p/Q Diagram		
Integral Check Valve	See p/Q Diagram		
Minimum Pilot Supply Pressure	5 Bar (73 PSI)		
Static / Dynamic			
Step Response at 85%		Energized	De-energized
DC Solenoids	Pilot Pressure		
	50 Bar [ms]	95	65
	100 Bar [ms]	75	65
	250 Bar & 350 Bar [ms]	60	65
AC Solenoids	Pilot Pressure		
	50 Bar [ms]	75	55
	100 Bar [ms]	65	55
	250 Bar & 350 Bar [ms]	40	55

Position Control M12x1

Protection Class	IP 65 in accordance with EN 60529 (plugged and mounted)
Ambient Temperature [°C]	0...+50; (+32°F...122°F)
Supply Voltage / Ripple [V]	18...42 ±10%
Current Consumption without Load [mA]	≤ 30
Max. Output Current per Channel, Ohmic [mA]	400
Min. Output Load per Channel, Ohmic [kOhm]	100
Max. Output Drop at 0.2A [V]	≤ 1.1
Max. Output Drop at 0.4A [V]	≤ 1.6
EMC	EN50081-1 / EN50082-2
Max. Tolerance Ambient Field Strength [A/m]	<1200
Min. Distance to Next AC Solenoid [m]	>0.1
Interface	M12x1 per IEC 61076-2-101
Wiring Minimum [mm²]	5 x 0.25 braided shield recommended
Wiring Length Maximum [m]	50 (164 ft.) recommended



M12 Pin Assignment

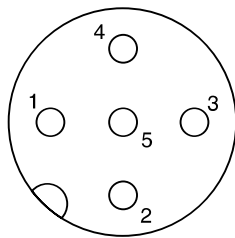

- 1 + Supply 18...42V
- 2 Out B: normally closed
- 3 0V
- 4 Out A: normally open
- 5 Earth ground

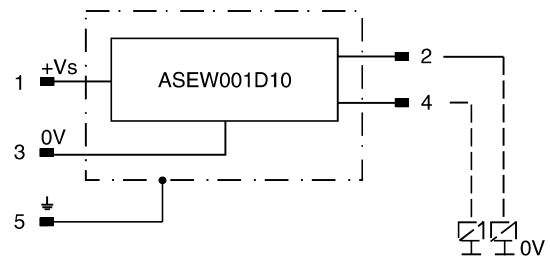

Definitions

Start position monitored:

The valve is de-energized. The inductive switch gives a signal at the moment (below 15% spool stroke) when the spool leaves the spring offset position.

End position monitored:

The inductive switch gives a signal before the end position is reached. (above 85% spool stroke).

Delivery includes plug M12 x 1 (order no.: 5004109).

Performance Curves

The flow curve diagram shows the flow versus pressure drop curves for all spool types. The relevant curve number for each spool type, operating position and flow direction is given in the table below.

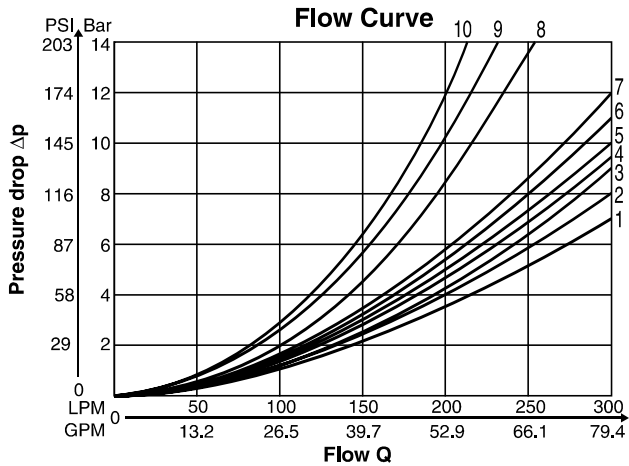

All characteristic curves measured with HLP46 at 50°C.

Spool Code	Curve Number				
	P-A	P-B	P-T	A-T	B-T
001	1	1	-	4	5
002	1	2	6	4	6
003	1	2	-	5	6
004	1	1	-	5	5
005	2	2	-	3	5
006	1	2	-	3	6
007	1	1	6	4	5
009	2	9	8	7	10
011	1	1	-	4	5
014	1	1	6	4	5
015	1	2	-	4	6
016	2	2	-	3	5
020	3	5	-	3	5
021	2	8	-	2	-
022	8	2	-	-	3
026	3	5	-	-	-
030	2	3	-	6	7
054	2	3	-	6	7

Integral Check Valve in the P port

Mounting an integral check valve in the P port is necessary to build up pilot pressure for valves with P to T connection and internal pilot oil supply. The pressure difference at the integral check valve (see performance curves) is to be added to all flow curves of the P-port of the main valve.

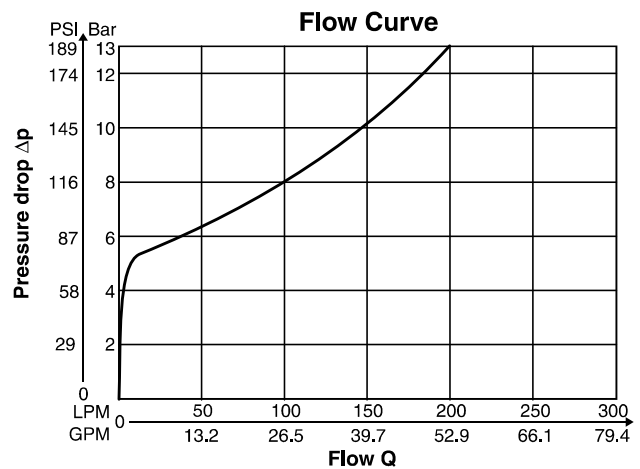

Pilot Oil Inlet (Supply) and Outlet (Drain)

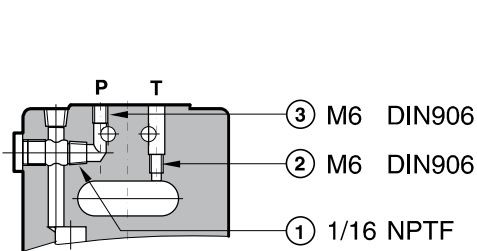

○ open, ● closed

Pilot Oil Inlet	Pilot Oil Outlet	Orifice Size		
		1	2	3
internal	external	○	●	Orifice \varnothing 1.5
external	external	●	●	Orifice \varnothing 1.5
internal	internal	○	○	Orifice \varnothing 1.5
external	internal	●	○	Orifice \varnothing 1.5

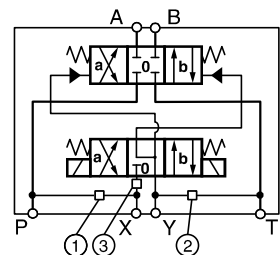

All orifice sizes for standard valves

Manaplug (Options 6, 56, 1A & 1C)

- Interface – Brad Harrison Plug
- 3-Pin for Single Solenoid
- 5-Pin for Double Solenoid

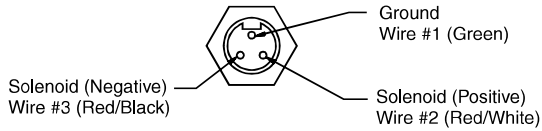

3-Pin Manaplug (Mini) with Lights

Single Solenoid Valves – Installed Opposite Side of Solenoid

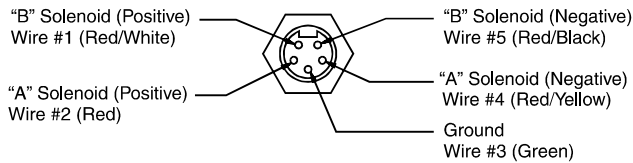

5-Pin Manaplug (Mini) with Lights

Single Solenoid Valves – Installed Opposite Side of Solenoid
Double Solenoid Valves – Installed Over "A" Solenoid
("A" and "B" Solenoids Reversed for #8 and #9 Spools)

Micro Connector Options (7A, 7B, 1B & 1D)

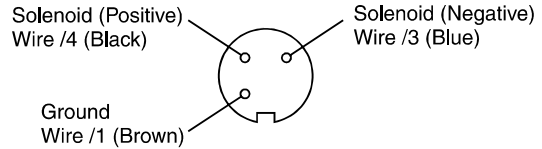

3-Pin Manaplug (Micro) with Lights

Single Solenoid Valves – Installed Opposite Side of Solenoid

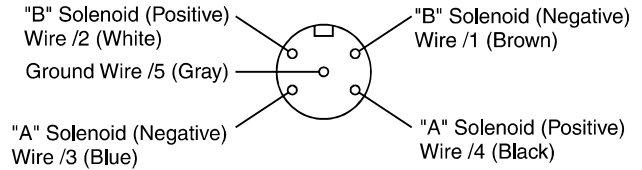

5-Pin Manaplug (Micro) with Lights

Single Solenoid Valves – Installed Opposite Side of Solenoid
Double Solenoid Valves – Installed Over "A" Solenoid
("A" and "B" Solenoids Reversed for #8 and #9 Spools)

Pins are as seen on valve (male pin connectors)

Manaplug – Electrical Mini Plug

- EP336-30 3 Pin Plug
- EP316-30 5 Pin Plug (Double Solenoid)
- EP31A-30 5 Pin Plug (Single Solenoid)

Manaplug – Electrical Micro Plug

- EP337-30 3 Pin Plug
- EP317-30 5 Pin Plug (Double Solenoid)
- EP31B-30 5 Pin Plug (Single Solenoid)

Conduit Box Option C

- No Wiring Options Available

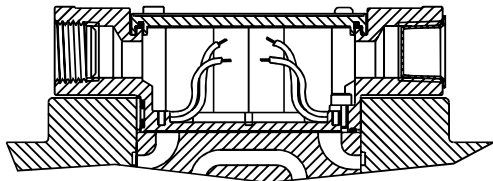

Signal Lights (Option 5) — Plug-in Only

- LED Interface
- Meets Nema 4/IP67

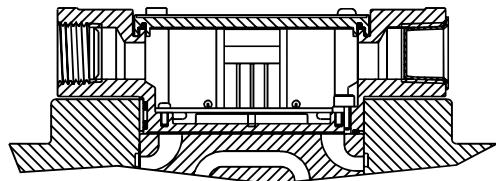

**Hirschmann Plug with Lights (Option P5)
ISO 4400/DIN 43650 Form "A"**

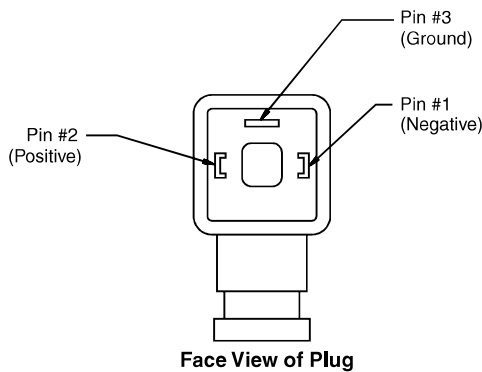

Pins are as seen on valve (male pin connectors)

DESINA Connector (Option D)

**M12 pin assignment
Standard**

- 1 = Not used
- 2 = Not used
- 3 = 0V
- 4 = Signal (24 V)
- 5 = Earth Ground

