

## 4/2 and 4/3 Directional Control Valve, Solenoid Operated

### RPE3-06

Size 06 (D03) • Q<sub>max</sub> 80 l/min (21 GPM) • p<sub>max</sub> 350 bar (5100 PSI)

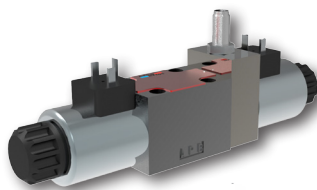

#### Technical Features

- › Direct acting, directional control valve with subplate mounting interface acc. to ISO 4401, DIN 24340 (CETOP 03)
- › High transmitted hydraulic power up to 350 bar with optimized design to minimize pressure drop
- › Five chamber housing design with reduced hydraulic power dependence on fluid viscosity
- › The valve is available with interchangeable DC solenoids, also for AC power supply using a built-in rectifier bridge
- › Wide range of solenoid electrical terminal versions available
- › Wide range of interchangeable spools and manual overrides available
- › CSA Certificate upon request
- › Inductive contactless Normally Open and Normally Closed spool position sensor option
- › Soft-shift spool speed control option
- › The coil is fastened to the core tube with a retaining nut and can be rotated by 360° to suit the available space
- › In the standard version, the valve housing is phosphated and steel parts zinc-coated for 240 h salt spray protection acc. to ISO 9227
- › Enhanced surface protection for mobile sector available (ISO 9227, 520 h salt spray)

#### ISO 4401-03-02-0-05

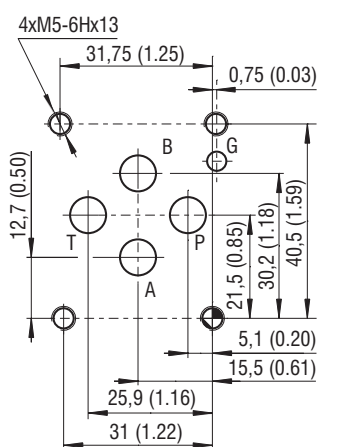

Ports P, A, B, T - max  $\varnothing$ 7.5 mm (0.29 in)

#### Technical Data

Valve size	06 (D03)	
Max. flow	l/min (GPM) 80 (21.1)	
Max. operating pressure at ports P, A, B	bar (PSI) standard 350 (5080) 320 (4640) acc. to CSA	
Max. operating pressure at port T	bar (PSI) 210 (3050), 50 (730) for monitoring S1, S4	
Fluid temperature range (NBR)	°C (°F) -30 ... +80 (-22 ... +176)	
Fluid temperature range (FPM)	°C (°F) -20 ... +80 (-4 ... +176)	
Ambient temperature range	°C (°F) -30 ... +50 (-22 ... +122)	
Supply voltage tolerance	%	
Max. switching frequency	1/h AC: $\pm$ 10 DC: $\pm$ 10	
Switching time at v=32 mm <sup>2</sup> /s (156 SUS)	15 000	
Switching time at v=32 mm <sup>2</sup> /s (156 SUS)	ON	ms AC: 30 ... 40 DC: 30 ... 50
	OFF	ms AC: 30 ... 70 DC: 10 ... 50
Mass	kg (lbs)	
- valve with 1 solenoid	1.6 (3.52)	
- valve with 2 solenoids	2.2(4.85)	
	Datasheet	Type
General information	GI_0060	Products and operating conditions
Coil types / connectors	C_8007 / K_8008	C22B* / K*
Mounting interface	SMT_0019	Size 06
Spare parts	SP_8010	

#### Characteristics measured at v = 32 mm<sup>2</sup>/s (156 SUS)

#### Operating limits

Operating limits for maximum hydraulic power at rated temperature and supply voltage equal to 90 % nominal.

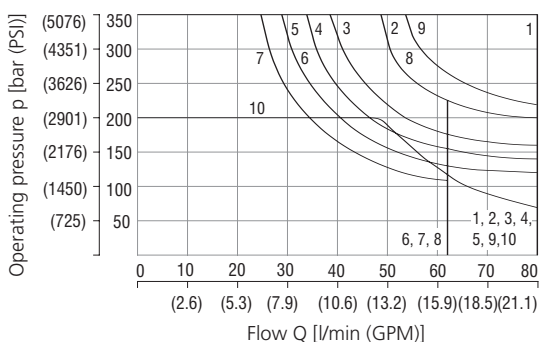

1	Z11	5	F11	7	Z91
6	C11	3	R11	5	R31
5	H11	4	R21	5	H51
1	P11	5	A51	7	F51
2	Y11	1	P51	3	X11
5	L21	2	Y51	7	K11
8	B11	6	C51	7	N11
6	Y41	1	Z51	10	X25
1	Z21	7	Z71	1	J15
5	C41	7	Z81	9	J75

#### Pressure drop related to flow rate

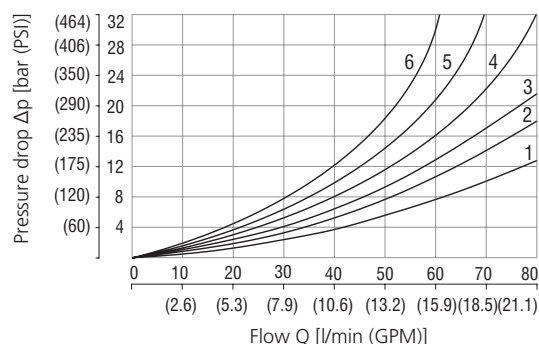

	P-A	P-B	A-T	B-T	P-T		P-A	P-B	A-T	B-T	P-T
Z11,L21,B11,R11	2	2	3	3		P51	1	3			
R21,X11,N11,J15						Y51	2	2			
C11	5	5	5	6	3	C51	2		3	4	
H11	2	2	2	3	3	Z71	3	3			
P11	1	1	3	3		Z81			3	3	
Y11	2	2	2	2		Z91	3			3	3
Y41	3	3	3	3		R31	2			3	
Z21,Z51,H51		2	3			F51	2	3			
C41	4	4			5	K11	2	3			
F11	1	2		3	3	X25	3	3	3		
A51,J75	2	2									

For operating limits under conditions and flow directions other than shown contact our technical support. Admissible operating limits may be considerably lower with only one direction of flow (A or B plugged, or without flow.)

**Ordering Code**

RPE3 - 06 [ ] [ ] / [ ] [ ] [ ] [ ] [ ] [ ] - [ ] [ ] [ ]

4/2 and 4/3 directional control valve, solenoid operated

Valve size

Number of spool positions

- two positions **2**
- three positions 3

Spool symbols

see the table "Spool Symbols"

Rated supply voltage of solenoids

(at the coil terminals)

- 12 V DC / 2.72 A 01200
- 24 V DC / 1.29 A 02400**
- 27 V DC / 1.07 A 02700
- 205 V DC / 0.15 A 20500
- 24 V AC / 1.56 A / 50 (60 Hz) 02450
- 120 V AC / 0.26 A / 60 Hz 12060
- 230 V AC / 0.15 A / 50 (60) Hz 23050

CSA upon request - only for 320 bar (4640 PSI)

Connector

- EN 175301-803-A E1**
- E1 with quenching diode E2
- AMP Junior Timer - axial direction (2 pins; male) E3A
- E3A with quenching diode E4A
- EN 175301-803-A with integrated rectifier E5
- Loose conductors (two insulated wires) E8
- E8 with quenching diode E9
- Deutsch DT04-2P - axial direction (2 pins; male) E12A
- E12A with quenching diode E13A

- For directional valves with two solenoids, one solenoid must be de-energized before the other solenoid can be charged.
- For AC voltage supply use coils with connector type E5.

No designation  
U

CSA Certified standard  
CSA marking

No designation

- A zinc-coated (ZnCr-3), ISO 9227 (240 h)
- B zinc-coated (ZnNi), ISO 9227 (520 h)

Surface treatment

standard

No designation

- S1 normally-open sensor, 50 bar (730 PSI) at port T
- S2 normally-open sensor, 210 bar (3050 PSI) at port T
- S4 normally-closed sensor, 50 bar (730 PSI) at port T

Spool monitoring

without sensors

No designation  
V

Seals

- NBR
- FPM (Viton)

Soft-shift spool speed control

without soft-shift control

No designation  
T1

orifice  $\varnothing$  0.7 mm (0.03 inch) in solenoid

Manual override

standard

No designation

- N1 cap nut covered**
- N2 rubber boot protected
- N3 detent assembly
- N4 hand screw
- N5 socket head screw
- N9 without manual override

- For other solenoid voltage supply options see data sheet C\_8007.
- The solenoid operated valves are delivered without connectors. For available connectors see data sheet K\_8008.
- The orifice to the P port can be ordered separately, see data sheet SP\_8010.
- Mounting bolts M5 x 45 DIN 912-10.9 or studs must be ordered separately. Tightening torque is 8.9 Nm (6.56 lbf.ft).
- Besides the shown, commonly used valve versions other special models are available. Contact our technical support for their identification, feasibility and operating limits.

**Spool Symbols**

Type	Symbol	Interposition	Type	Symbol	Interposition	Type	Symbol	Interposition
Z11			R11			Z11		
C11			R21			X11		
H11			A51			C11		
P11			P51			H11		
Y11			<b>Y51</b>			K11		
L21			C51			N11		
B11			Z51			F11		
Y41			Z71			X25		
Z21			Z81			J15		
C41			Z91			J75		
F11			R31					
			H51					
			F51					

### Solenoid Coil in millimeters (inches)

E1, E2	E3A, E4A	E5	E8, E9	E12A, E13A
Protection degree IP65	Protection degree IP67	Protection degree IP65	Protection degree IP65	Protection IP67 / 69K
			Note: A = Standard 300 mm, (11.8 in) other lengths on demand	

The indicated IP protection level is only achieved if the connector is properly mounted.

### Manual Override in millimeters (inches)

No designation - standard	Designation N1 - cap nut covered	Designation N2 - rubber boot protected	Designation N3 - detent assembly	Designation N4 - hand screw	Designation N5 - socket head screw, size 3	Designation N9 - without manual override

In case of solenoid malfunction or power failure, the spool of the valve can be shifted by manual override as long as the pressure in port T does not exceed 25 bar (363 PSI). For alternative manual overrides contact our technical support.

### Spool Position Sensor

**S1, S2** - Circuit diagram for the normally - **OPEN** sensor

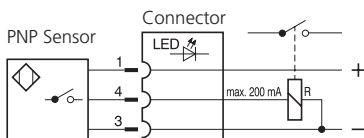

**S4** - Circuit diagram of the normally - **CLOSED** sensor

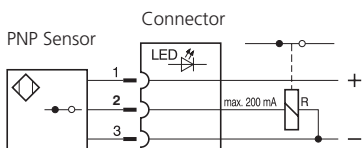

Technical Data of the Sensor		S1, S4	S2
Rated power supply voltage	V	24 DC	
Power supply voltage range	V	10 ... 30 DC	
Rated current	mA	200	
Sensor enclosure protection (EN 60529)		IP 67	
Max. operating pressure	bar (PSI)	50 (725)	210 (3046)
Switching frequency	Hz	1000	
Ambient temperature range	°C (°F)	-25 ... +80 (-13 ... +176)	
Technical Data of the Connector			
Power supply voltage range	V	10 ... 30 DC	
Ambient temperature range	°C (°F)	-25 ... +80 (-13 ... +176)	
Indicator		yellow LED	

① Signal of solenoid	Two-Position Directional Control Valve				
	② a(b)		③ Sa(Sb)		LED
	S1, S2	S4	S1, S2	S4	
0	1	0	ON	OFF	
1	0	1	OFF	ON	

① Signal of solenoid	Three-Position Directional Control Valve								
	② a(b)		③ Sa(Sb)			LED			
	a	b	Sa	Sb	S4	Sa - LED	Sb - LED	S4	
0	0	1	1	0	0	ON	ON	OFF	OFF
1	0	0	1	1	0	OFF	ON	ON	OFF

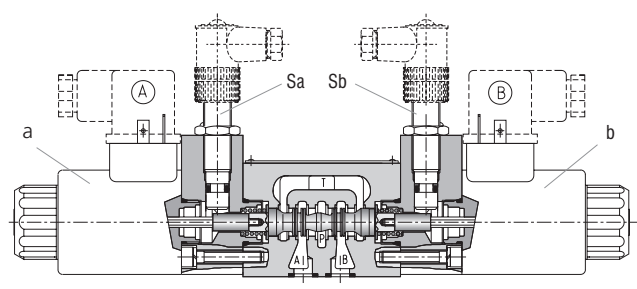
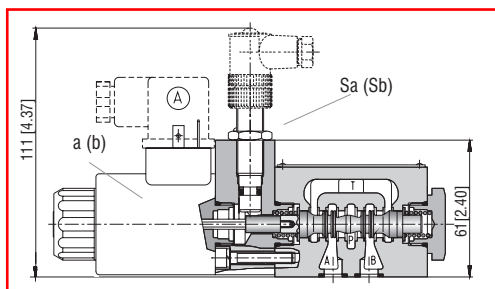

**Spool Speed Control** in millimeters (inches)

<b>Designation T1</b>	<b>Important:</b>
	<p>This directional valve provides the means to control spool soft shifting by an orifice situated in the solenoid armature. To ensure the proper function of the valve, unobstructed venting of the solenoid is required through the bleeding plug (1). The plugs are accessible after removing the rubber boot (2) from the solenoid cap nut (3).</p>
Switching time ON and OFF	300 ... 800 ms
<p>The switching times shown are valid for viscosity <math>\nu = 32 \text{ mm}^2/\text{s}</math> (156 SUS) and nominal voltage. They depend on working pressure and flow rate of the directional control valve.</p>	

**Dimensions** in millimeters (inches)

**Valve with two solenoids**

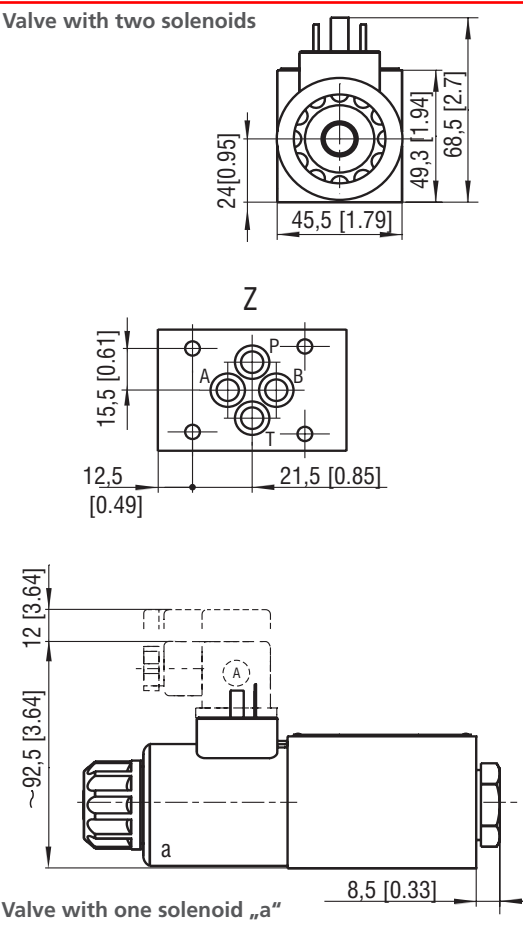

**Valve with one solenoid „a“**

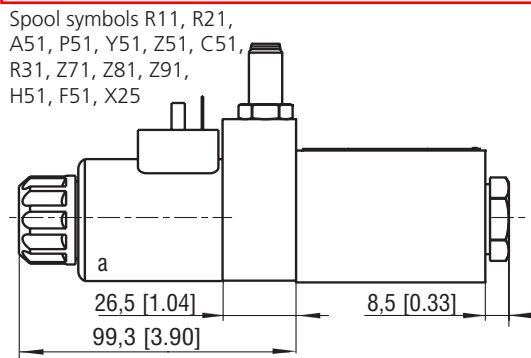

Spool symbols R11, R21, A51, P51, Y51, Z51, C51, R31, Z71, Z81, Z91, H51, F51, X25

**RPE3-063\*/E1\***

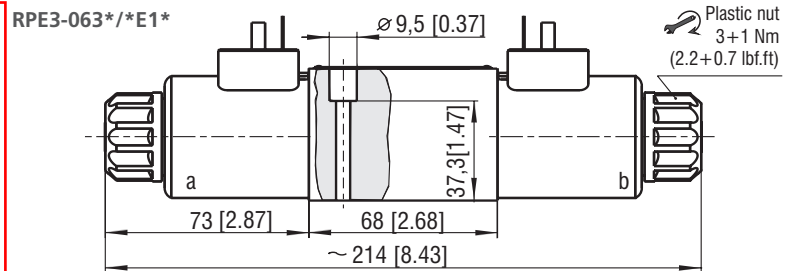

**RPE3-063\*/E1\*S**

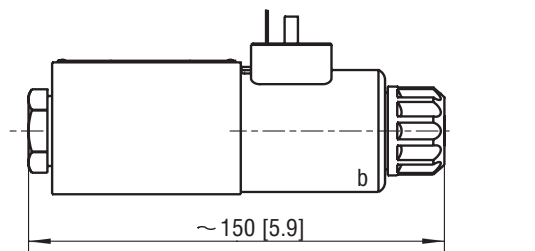
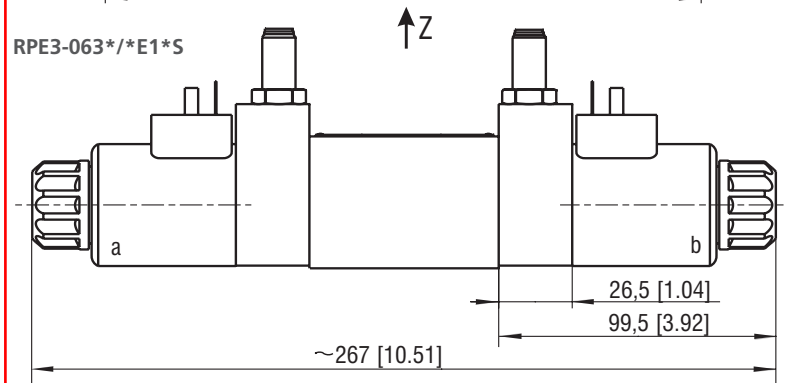

**Valve with one solenoid „b“**

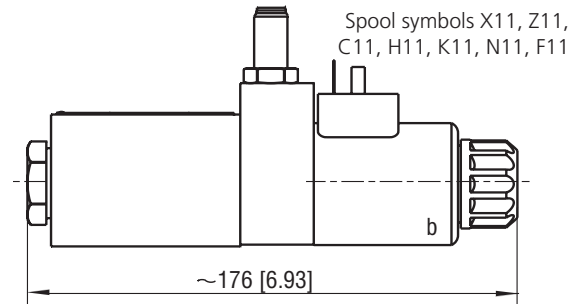

Spool symbols X11, Z11, C11, H11, K11, N11, F11

Mounting screws 8.9 Nm (7 lbf.ft)  
M5 x 45 DIN 912-10.9