



Mobile Hydraulic Pumps T6CCZ

Denison Vane Technology, fixed displacement

aerospace
climate control
electromechanical
filtration
fluid & gas handling
hydraulics
pneumatics
process control
sealing & shielding



ENGINEERING YOUR SUCCESS.

Ordering Code

Code: T6CCZ-B17-B10-XR00-A-100-

Model N°.

Series - SAE B 2 bolts
Mounting flange J 744 c

One letter can be added to specify special parts in series

Cam ring for "P1" and "P2"
(Delivery at 0 bar & 1500 r.p.m.)

- B03 = 16,2 l/min
- B05 = 25,8 l/min
- B06 = 31,9 l/min
- B08 = 39,6 l/min
- B10 = 51,1 l/min
- B12 = 55,6 l/min
- B14 = 69,0 l/min
- B17 = 87,4 l/min**
- B20 = 95,7 l/min
- B22 = 105,4 l/min
- B25 = 118,9 l/min
- B28 = 133,2 l/min
- B31 = 150,0 l/min

Type of shaft

- X = keyed**
- V = keyed
- W = keyed

T6CCZ - B22 - B10 - X R 00 - A - 1 00 -



Modifications

Mounting W/ connection variables

	P1 = 1"		S = 2"	
	UNC		Metric	
P2	1"	3/4"	1"	3/4"
Code	00	01	0M	W0
	P1 = 1"		S = 2.1/2"	
	UNC		Metric	
P2	1"	3/4"	1"	3/4"
Code	10	11	1M	W1

Seal class

1 = S1 - BUNA N (for mineral oil)

Design letter

Porting combination (see page 3)

Direction of rotation (view on shaft end)

R = clockwise

L = counter-clockwise

INTERNAL LEAKAGE (TYPICAL)

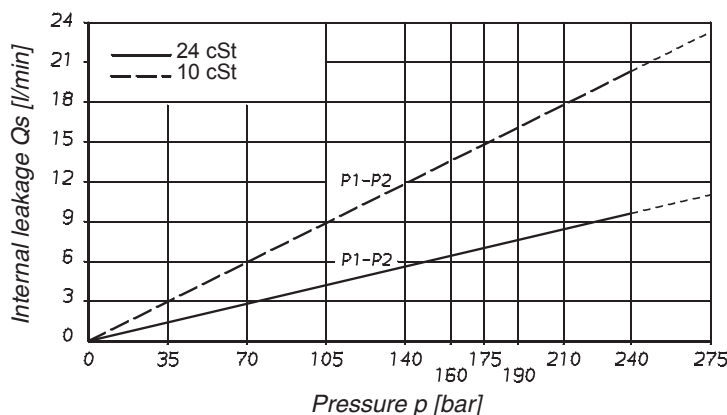

POWER LOSS HYDROMECHANICAL (TYPICAL)

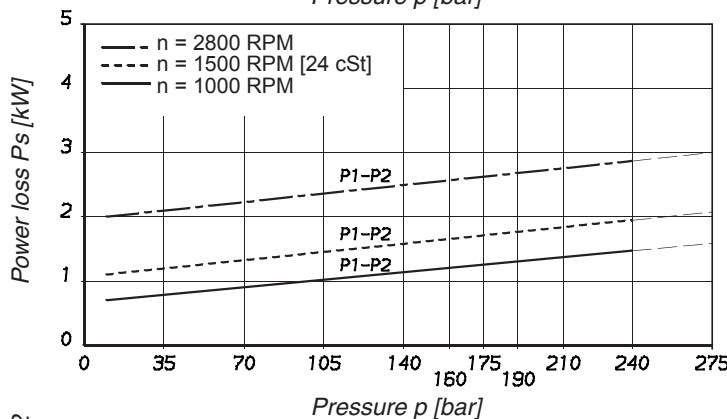

NOISE LEVEL (TYPICAL)

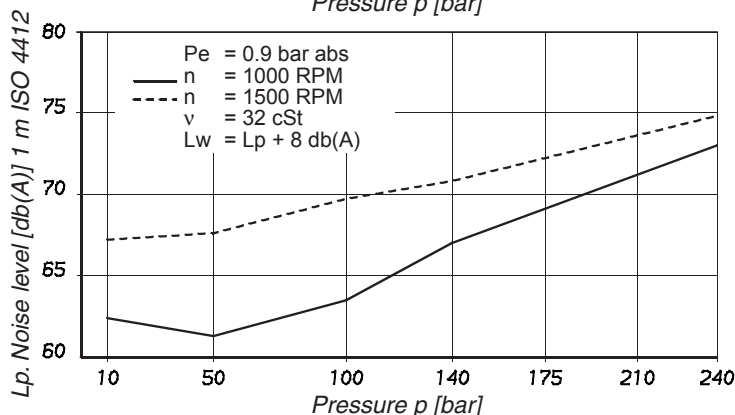

PORTING COMBINATION

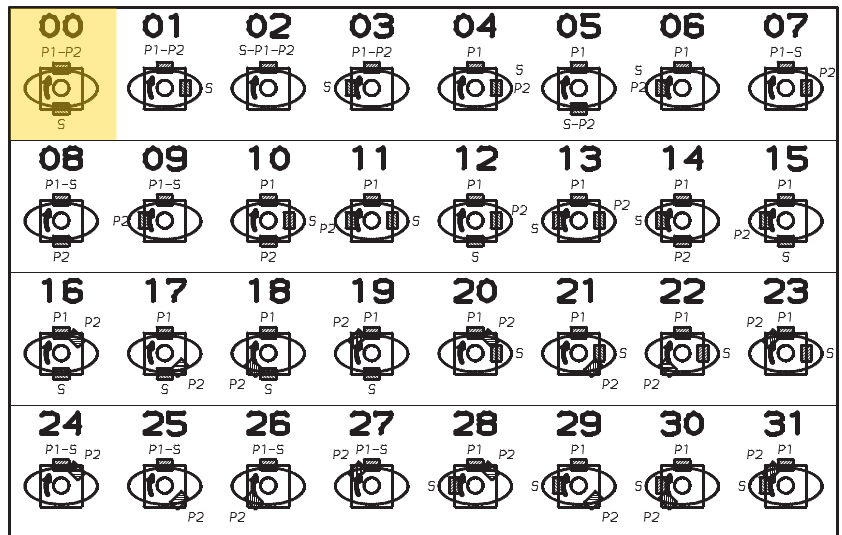

GENERAL DESCRIPTION

The T6CCZ pump incorporates Parker high quality and performances of T6CC series vane pumps mobile application. High maximum permissible shaft loads is particularly well adapted to applications of pump driven by cardan. A double raw ball bearing and a needle bearing double the permissible radial load compare to standard T6CC bearing capability. (see page 4).

GREATER FLOW

3 to 31 GPM, 10 to 100 ml/rev.

HIGHER PRESSURE

275 bar maximum except B28 and B31 cartridge 210 bar.

WIDER SPEED RANGE

400 up to 2800 RPM with petroleum based antiwear R & O fluids which are the recommended fluids.(except B25, B28, B31 - 2500 RPM max. speed)

BETTER EFFICIENCY

Better than 94 % for energy saving.

MOUNTING FLEXIBILITY

Up to 32 positions.

WIDER RANGE OF ACCEPTABLE VISCOSITY

2000 cSt max. viscosity (cold start low speed and pressure).
 30 cSt optimum (max. life).
 10 cSt minimum (full speed and pressure)

**PERMISSIBLE RADIAL LOAD
SHAFT CODE X**

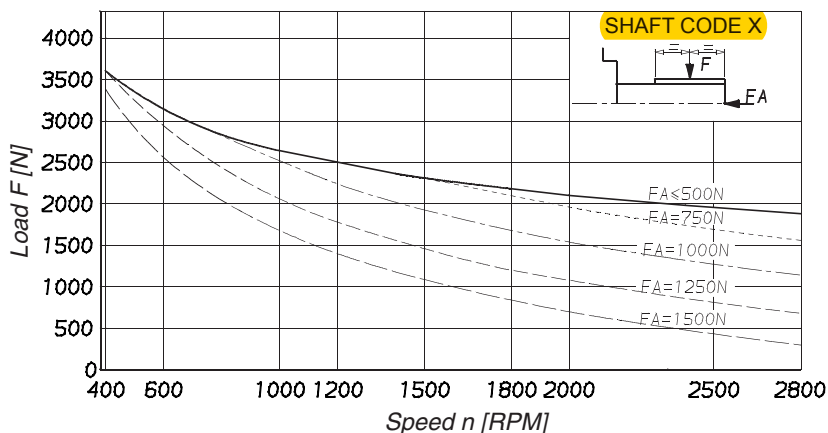

**PERMISSIBLE RADIAL LOAD
SHAFT CODE V**

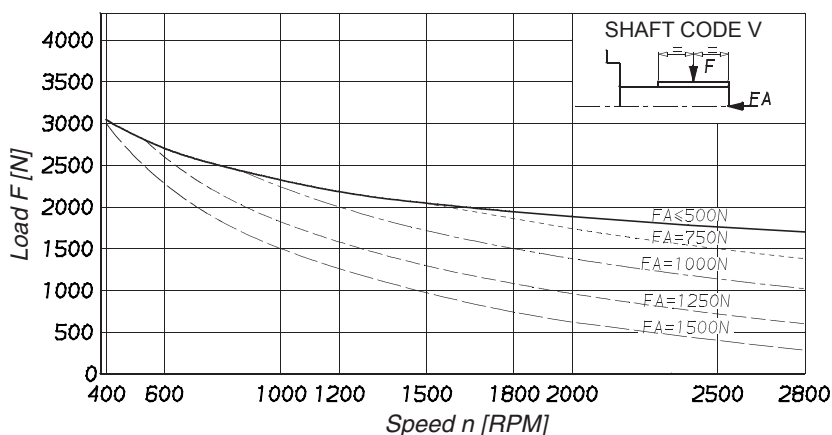

**PERMISSIBLE RADIAL LOAD
SHAFT CODE W**

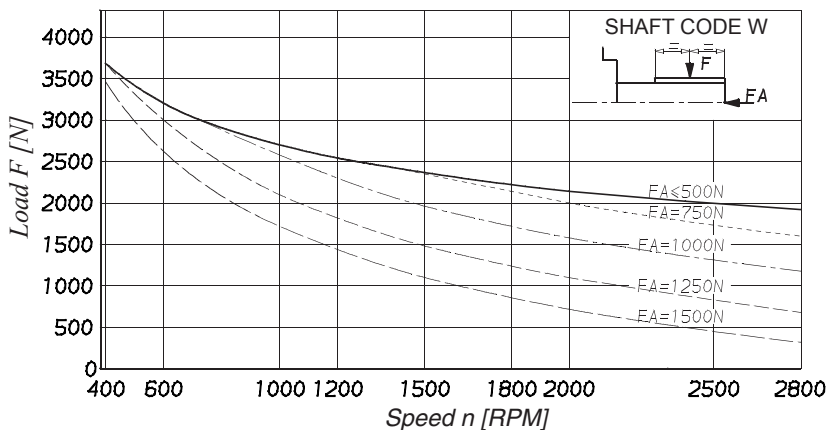

These curves permit to simultaneously check the maximum permissible radial and axial load on the shaft involved. Those load value are determined for 10 000 hours bearing lifetime at operating under F_a and F given to get information for a different lifetime the radial load corrected is.

If F_a is smaller than minimum axial force on the curves then

$$\text{Correct } F = \frac{F \text{ curve}}{3,33 \sqrt{\frac{LH \text{ Required}}{10000}}} \quad LH = \text{Lifetime in hours}$$

If F_a is higher than minimum axial force then F radial load is :

$$\text{Correct } F = \frac{F \text{ curve}}{3 \sqrt{\frac{LH \text{ Required}}{10000}}}$$

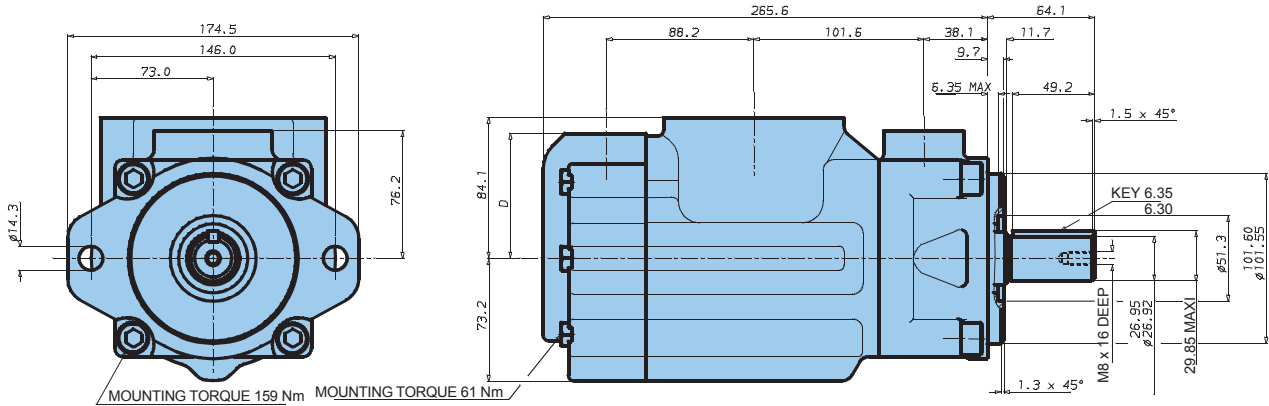

Shaft Code X

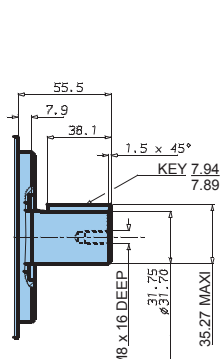

Shaft Code W

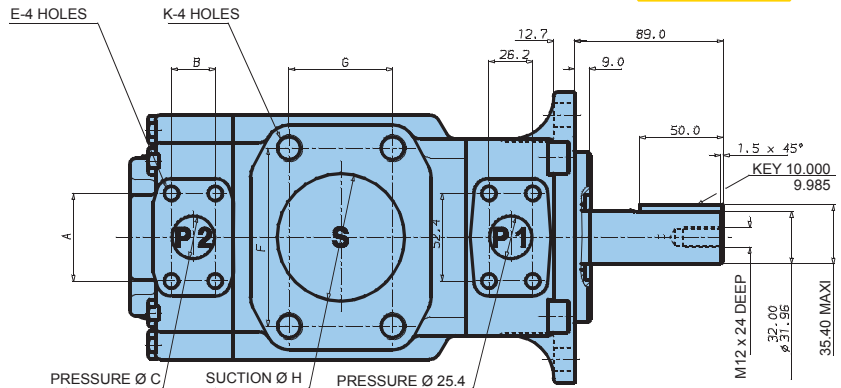

Shaft Code V

Shaft torque limits [ml/rev. x bar]	
Shaft	Vi x p max P1 + P2
X	25400
V	32670
W	32670

	Alternate Port							
	S = 3"				S = 2" 1/2 ²⁾			
F	106,4				88,9			
G	61,9				50,8			
Ø H	76,2				63,5			
Code	00	01 ¹⁾	0M	M0 ¹⁾	10	11 ¹⁾	1M	M1 ¹⁾
A	52,4	47,7	52,4	47,7	52,4	47,7	52,4	47,7
B	26,2	22,4	26,2	22,4	26,2	22,4	26,2	22,4
Ø C	25,4	19,0	25,4	19,0	25,4	19,0	25,4	19,0
D	74,7	76,2	74,7	76,2	74,7	76,2	74,7	76,2
E	3/8"-16 UNC x 19,0 deep		M10 x 19,0 deep		3/8"-16 UNC x 19,0 deep		M10 x 19,0 deep	
K	5/8"-11UNC x 28,4 deep		M16 x 28,4 deep		1/2"-13 UNC x 23,9 deep		M12 x 23,9 deep	

¹⁾ max. cam 014

²⁾ P1 + P2 = 126 cm³ / rev max.

OPERATING CHARACTERISTICS - TYPICAL (24 cSt)

Pressure port	Series	Volumetric displ. Vi ml/rev.	Flow Q [l/min] n = 1500 RPM			Input power P [kW] n = 1500 RPM		
			p = 0 bar	p = 140 bar	p = 240 bar	p = 7 bar	p = 140 bar	p = 240 bar
P1 & P2	B03	10,8	16,2	10,7	-	1,3	5,3	-
	B05	17,2	25,8	20,3	15,8	1,4	7,5	12,2
	B06	21,3	31,9	26,4	21,9	1,5	8,9	14,7
	B08	26,4	39,6	34,1	29,6	1,6	10,7	17,7
	B10	34,1	51,1	45,6	41,1	1,7	13,4	22,3
	B12	37,1	55,6	50,1	45,6	1,7	14,4	24,1
	B14	46,0	69,0	63,5	59,0	1,9	17,6	29,5
	B17	58,3	87,4	81,9	77,4	2,1	21,9	36,9
	B20	63,8	95,7	90,7	85,7	2,2	23,8	40,2
	B22	70,3	105,4	99,9	95,4	2,3	26,1	44,1
B25*	79,3	118,9	113,4	108,9	2,5	29,2	49,5	
B28*	88,8	133,2	127,7	124,5**	2,8	32,7	48,5**	
B31*	100,0	150,0	144,5	141,3**	2,8	36,5	54,4**	

* B25 - B28 - B31 = 2500 R.P.M. max.

** B28 - B31 = 210 bar max. int.

- Not to use because internal greater than 50 % theoretical flow.

Parker Worldwide

AE – UAE, Dubai
Tel: +971 4 8127100
parker.me@parker.com

AR – Argentina, Buenos Aires
Tel: +54 3327 44 4129

AT – Austria, Wiener Neustadt
Tel: +43 (0)2622 23501-0
parker.austria@parker.com

AT – Eastern Europe, Wiener Neustadt
Tel: +43 (0)2622 23501 900
parker.easteurope@parker.com

AU – Australia, Castle Hill
Tel: +61 (0)2-9634 7777

AZ – Azerbaijan, Baku
Tel: +994 50 2233 458
parker.azerbaijan@parker.com

BE/LU – Belgium, Nivelles
Tel: +32 (0)67 280 900
parker.belgium@parker.com

BR – Brazil, Cachoeirinha RS
Tel: +55 51 3470 9144

BY – Belarus, Minsk
Tel: +375 17 209 9399
parker.belarus@parker.com

CA – Canada, Milton, Ontario
Tel: +1 905 693 3000

CH – Switzerland, Etoy
Tel: +41 (0) 21 821 02 30
parker.switzerland@parker.com

CL – Chile, Santiago
Tel: +56 2 623 1216

CN – China, Shanghai
Tel: +86 21 2899 5000

CZ – Czech Republic, Klecany
Tel: +420 284 083 111
parker.czechrepublic@parker.com

DE – Germany, Kaarst
Tel: +49 (0)2131 4016 0
parker.germany@parker.com

DK – Denmark, Ballerup
Tel: +45 43 56 04 00
parker.denmark@parker.com

ES – Spain, Madrid
Tel: +34 902 330 001
parker.spain@parker.com

FI – Finland, Vantaa
Tel: +358 (0)20 753 2500
parker.finland@parker.com

FR – France, Contamine s/Arve
Tel: +33 (0)4 50 25 80 25
parker.france@parker.com

GR – Greece, Athens
Tel: +30 210 933 6450
parker.greece@parker.com

HK – Hong Kong
Tel: +852 2428 8008

HU – Hungary, Budapest
Tel: +36 1 220 4155
parker.hungary@parker.com

IE – Ireland, Dublin
Tel: +353 (0)1 466 6370
parker.ireland@parker.com

IN – India, Mumbai
Tel: +91 22 6513 7081-85

IT – Italy, Corsico (MI)
Tel: +39 02 45 19 21
parker.italy@parker.com

JP – Japan, Fujisawa
Tel: +(81) 4 6635 3050

KR – South Korea, Seoul
Tel: +82 2 559 0400

KZ – Kazakhstan, Almaty
Tel: +7 7272 505 800
parker.easteurope@parker.com

LV – Latvia, Riga
Tel: +371 6 745 2601
parker.latvia@parker.com

MX – Mexico, Apodaca
Tel: +52 81 8156 6000

MY – Malaysia, Shah Alam
Tel: +60 3 7849 0800

NL – The Netherlands, Oldenzaal
Tel: +31 (0)541 585 000
parker.nl@parker.com

NO – Norway, Ski
Tel: +47 64 91 10 00
parker.norway@parker.com

NZ – New Zealand, Mt Wellington
Tel: +64 9 574 1744

PL – Poland, Warsaw
Tel: +48 (0)22 573 24 00
parker.poland@parker.com

PT – Portugal, Leca da Palmeira
Tel: +351 22 999 7360
parker.portugal@parker.com

RO – Romania, Bucharest
Tel: +40 21 252 1382
parker.romania@parker.com

RU – Russia, Moscow
Tel: +7 495 645-2156
parker.russia@parker.com

SE – Sweden, Spånga
Tel: +46 (0)8 59 79 50 00
parker.sweden@parker.com

SG – Singapore
Tel: +65 6887 6300

SK – Slovakia, Banská Bystrica
Tel: +421 484 162 252
parker.slovakia@parker.com

SL – Slovenia, Novo Mesto
Tel: +386 7 337 6650
parker.slovenia@parker.com

TH – Thailand, Bangkok
Tel: +662 717 8140

TR – Turkey, Istanbul
Tel: +90 216 4997081
parker.turkey@parker.com

TW – Taiwan, Taipei
Tel: +886 2 2298 8987

UA – Ukraine, Kiev
Tel: +380 44 494 2731
parker.ukraine@parker.com

UK – United Kingdom, Warwick
Tel: +44 (0)1926 317 878
parker.uk@parker.com

US – USA, Cleveland (industrial)
Tel: +1 216 896 3000

US – USA, Lincolnshire (mobile)
Tel: +1 847 821 1500

VE – Venezuela, Caracas
Tel: +58 212 238 5422

ZA – South Africa, Kempton Park
Tel: +27 (0)11 961 0700
parker.southafrica@parker.com

European Product Information Centre
Free phone: 00 800 27 27 5374
(from AT, BE, CH, CZ, DE, DK, EE, ES, FI, FR, IE, IL, IS, IT, LU, MT, NL, NO, PL, PT, RU, SE, UK, ZA)



Parker Hannifin Ltd.
Tachbrook Park Drive
Tachbrook Park, Warwick CV34 6TU
United Kingdom
Tel.: +44 (0) 1926 317 878
Fax: +44 (0) 1926 317 855
www.parker.com