

Denison Hydraulikpumpen Industrierausführung

T7/T67/T6 Flügelzellentechnologie

aerospace
climate control
electromechanical
filtration
fluid & gas handling
hydraulics
pneumatics
process control
sealing & shielding



ENGINEERING YOUR SUCCESS.

Doppel- und Dreifachpumpen : Drehzahlen, Drücke T7/T67/T6C

Baureihe	Hubring	Geometrisches Fördervolumen Vgeom. cm³/U	Drehzahl min. min ⁻¹	Drehzahl max. ³⁾		Betriebsdruck max.																					
				HF-0, HF-1 HF-2	HF-3, HF-4 HF-5	HF-0, HF-2		HF-1, HF-4, HF-5		HF-3																	
				min ⁻¹	min ⁻¹	Kurzzeitig bar	Dauernd bar	Kurzzeitig bar	Dauernd bar	Kurzzeitig bar	Dauernd bar																
T7BB/S T67CB T7DB/S T7EB/S T7DDB/S T7DCB/S T7DDB/S T7EDB/S	B02	5,8	600	2200 ²⁾	1800	T7BB T7BBS 320 ¹⁾	T7BB T7BBS 290	Andere Pumpen 300	Andere Pumpen 275	240	210	175	140														
	B03	9,8																									
	B04	12,8																									
	B05	15,9																									
	B06	19,8																									
	B07	22,5																									
	B08	24,9																									
	B09	28,0																									
	B10	31,8																									
	B11	35,0																									
	B12	41,0																									
	B14	45,0																									
	B15	50,0																									
														280	240												
	T6CC T67CB T67DC T67EC T7DCB/S T7DCC/S T67DDC/S T67EDC/S T7EEC/S	003												10,8	600	2200 ²⁾	1800					275	240	210	175	175	140
005		17,2																									
006		21,3																									
008		26,4																									
010		34,1																									
012		37,1																									
014		46,0																									
017		58,3																									
020		63,8																									
022		70,3																									
025		79,3																									
028		88,8																									
031		100,0																									
						210	160			160																	
T7DB/S T67DC T7DD/S T7EDS T7DDB/S T7DCB/S T7DCC/S T7DDB/S T67DDC/S T7EDB/S T67EDC/S		B14	44,0	600	2200 ²⁾	1800	300	250	240	210	175	140															
	B17	55,0																									
	B20	66,0																									
	B22	70,3																									
	B24	81,1																									
	B28	90,0																									
	B31	99,2																									
	B35	113,4																									
	B38	120,6																									
	B42	137,5																									
	045 ¹⁾	145,7																									
	050 ¹⁾	158,0																									
													280														
													260	230													
													240	210			175										
						210			210			160															
T7EB/S T67EC T7EDS T7EE/S T7EEC/S T67EDB/S T67EDC/S	042	132,3	600	2200 ²⁾	1800	240	210	210	175	175	140																
	045	142,4																									
	050	158,5																									
	052	164,8																									
	054	171,0																									
	057	183,3																									
	062	196,7																									
	066	213,3																									
	072	227,1																									
	085	268,7																									
						2000																					
						90	75			75			75														

HF-0, HF-2 = H-LP Mineralöle - HF-1 = H-L Mineralöle - HF-3 = Invertierte Emulsionen

HF-4 = Wasserglykole - HF-5 = Synthetische Flüssigkeiten

¹⁾ Für Betriebsdrücke über 300 bar wenden Sie sich bitte an Parker.

²⁾ Für höhere Drehzahlen setzen Sie sich bitte mit Parker in Verbindung.

³⁾ Sicherstellen, dass die Einflusgeschwindigkeit unter 1,9 m/sek beträgt (siehe S. 12, Überprüfungen vor Inbetriebnahme).

Wenn Sie weitere Informationen wünschen, oder die oben angegebenen Daten Ihre Anforderungen nicht erfüllen, setzen Sie sich bitte mit Ihrer örtlichen Parker-Vertretung in Verbindung.



Zulässiger Mindesteinlaßdruck (bar absolut)

Pumpeneinsatz		Drehzahl min ⁻¹										Hubring					
Größe	Hubring	1200	1500	1800	2100	2200	2300	2500	2800	3000	3600						
AS	B06	0,80	0,80	0,80	0,80	0,80	0,80	0,80	0,80	0,80	0,80	0,80	B06				
	B10												B10				
	B11												B11				
	B13												B13				
	B17												0,88	B17			
	B20												0,94	B20			
	B22												1,00	B22			
	B25											0,85	B25				
ASW	B26	0,80	0,80	0,80	0,80	0,80	0,80	0,80	0,80	0,80	0,80	0,80	B26				
	B28												B28				
	B30												B30				
	B32												B32				
	B34											0,88	B34				
	B36											0,94	B36				
	B40											1,00	B40				
B	B02	0,80	0,80	0,80	0,80	0,80	0,80	0,80	0,80	0,80	0,80	0,80	B02				
	B03												B03				
	B04												B04				
	B05												B05				
	B06												0,82	0,98	B06		
	B07											0,85	1,05	B07			
	B08											0,85	1,05	B08			
	B09											0,85	1,05	B09			
	B10											0,90	1,15	B10			
	B11											0,90	1,15	B11			
	B12											0,90	1,15	B12			
	B14											0,84	0,99	1,13	B14		
	B15											0,84	0,99	1,13	B15		
	C											003	0,80	0,80	0,80	0,80	0,80
005		005															
006		006															
008		008															
010		0,85	0,92	010													
012		0,85	0,95	012													
014		0,85	0,95	014													
017		0,90	0,98	017													
020		0,85	0,90	0,98	1,05	020											
022		0,90	0,95	0,95	1,05	022											
028		0,90	0,98	0,98	1,08	028											
031		0,85	0,90	1,11	1,11	031											

Eingangsdruck gemessen am Eingangsflansch mit Mineralöl einer Viskosität von 10 bis 65 cSt. Die Differenz zwischen Eingangsdruck am Pumpenflansch und dem atmosphärischen Druck darf höchstens 0,2 bar betragen, damit keine Luft angesaugt wird.

Bei Betriebsmedien der Klasse HF-3 und HF-4 ist der absolute Druck mit dem Faktor 1,25 zu multiplizieren.

mit Faktor 1,35 für HF-5-Medien.

mit Faktor 1,10 für Ester oder Rapsöl.

Für Doppel- und Dreifachpumpen ist der Einsatz zu wählen, der den höchsten absoluten Druck fordert.

	Befestigungsnorm	Masse ohne Steckverbinder und Träger - kg	Trägheitsmoment Kgm ² x 10 ⁻⁴	SAE 4-Loch Flansche - J518 - ISO/DIS6162-1		
				Sauganschluß	Druckanschluß	
				S	P	
T7AS	SAE J744 SAE A	9,5	2,6	1"-SAE 4-Loch J518-ISO/DIS 6162-1	3/4"-SAE 4-Loch J518-ISO/DIS 6162-1	
				SAE 16-SAE Gewinde 1.5/16"-12 UNF-2B	SAE 12-SAE Gewinde 1.1/16"-12 UNF-2B	
				NPTF Gewinde 1.1/4" NPTF	NPTF Gewinde 3/4" NPTF	
				1" BSPP Gewinde	3/4" BSPP Gewinde	
T7ASW	SAE J744 SAE A	11,3	3,2	1.1/4"-SAE 4-Loch J518-ISO/DIS 6162-1	3/4"-SAE 4-Loch J518-ISO/DIS 6162-1	
				SAE 20-SAE Gewinde 1.5/8"-12 UNF-2B	SAE 12-SAE Gewinde 1.1/16"-12 UNF-2B	
				NPTF Gewinde 1.1/4" NPTF	SAE 12-SAE Gewinde 1.1/16"-12 UNF-2B	
				1.1/4" BSPP Gewinde	3/4" BSPP Gewinde	
T7B	ISO/3019-2 100 A2 HW	23,0	3,2	1.1/2"	1" oder 3/4"	
T7BS	SAE J744 SAE B					
T6C	SAE J744 SAE B	15,7	7,5	1.1/2"	1"	
T7D	ISO 3019-2 125 A2 HW	26,0	19,6	2"	1.1/4"	
T7DS	SAE J744 SAE C					
T7E	ISO 3019-2 125 A2 HW	43,3	62,5	3"	1.1/2"	
T7ES	SAE J744 SAE C					
				S	P1	P2
T7BB	ISO 3019-2 100 A2 HW	32,6	6,7	2.1/2"	1" oder 3/4"	
T7BBS	SAE J744 SAE B					
T6CC	SAE J744 SAE B	26,0	16,9	2.1/2" oder 3"	1"	1" oder 3/4"
T67CB	SAE J744 SAE B	26,0	11,4	2.1/2"	1"	3/4"
T7DB	ISO 3019-2 125 A2 HW	38,6	22,7	3"	1.1/4"	
T7DBS	SAE J744 SAE C					
T67DC	SAE J744 SAE C	38,6	26,3	3"	1.1/4"	1" oder 3/4"
T7DD	ISO 3019-2 125 A2 HW 125 B4 HW	56,0	36,3	4"	1.1/4"	
T7DDS	SAE J744 SAE C					
T7EB	ISO 3019-2 125 A2 HW	55,0	65,9	3.1/2"	1.1/2"	
T7EBS	SAE J744 SAE C					
T67EC	SAE J744 SAE C	55,0	70,8	3.1/2"	1.1/2"	1"
T7ED	ISO 3019-2 125 A2 HW	66,0	79,7	4"	1.1/2"	
T7EDS	SAE J744 SAE C					
T7EE	ISO 3019-2 250 B4 HW	95,0	97,4	4"	1.1/2"	
T7EES	SAE J744 SAE E					

T67CB - Bestellschlüssel

Code: T67CBW-B25-B10-VR05-A1M1

Typenbezeichnung

T67CB W - 010 - B10 - 1 R 00 - A 1 M1 - ..

Baureihe T67CB - 2-Loch-Flansch
nach SAE B, J744

Verstärkte Welle Option

Hubring P1

Geometrisches Fördervolumen (cm³/U)

003 = 10,8	017 = 58,3
005 = 17,2	020 = 63,8
006 = 21,3	022 = 70,3
008 = 26,4	025 = 79,3
010 = 34,1	028 = 88,8
012 = 37,1	031 = 100,0
014 = 46,0	

Hubring P2

Geometrisches Fördervolumen (cm³/U)

B02 = 5,8	B09 = 28,0
B03 = 9,8	B10 = 31,8
B04 = 12,8	B11 = 35,0
B05 = 15,9	B12 = 41,0
B06 = 19,8	B14 = 45,0
B07 = 22,5	B15 = 50,0
B08 = 24,9	

Art der Welle T67CB

- 1 = Paßfederwelle (nicht SAE)
- 3 = Vielkeilwelle (SAE BB) Zähnezahl 15
- 5 = Vielkeilwelle (SAE B) Zähnezahl 13

Art der Welle T67CBW

- 2 = Paßfederwelle (SAE BB)

Modifikationen

Gehäuse-Anschlußgröße

11 = SAE 4-Loch-Flansch (J518)

UNC Gewinde

M1 = SAE 4-Loch-Flansch (J518)

Metrische Gewinde

Dichtungsklasse

1 = S1 BUNA N - 0,7 bar max. (für Mineralöl)

4 = S4 EPDM - 7 bar max. (für schwerentflammare Flüssigkeiten)

5 = S5 VITON® - 7 bar max. (für Mineralöl und schwerentflammare Flüssigkeiten)

Ausführung

Lage der Anschlüsse (siehe Seite 72)

00 = standard

Drehrichtung (auf Wellenende gesehen)

R = Rechtslauf

L = Linkslauf

FÖRDERSTROMVERLUST (TYPISCH)

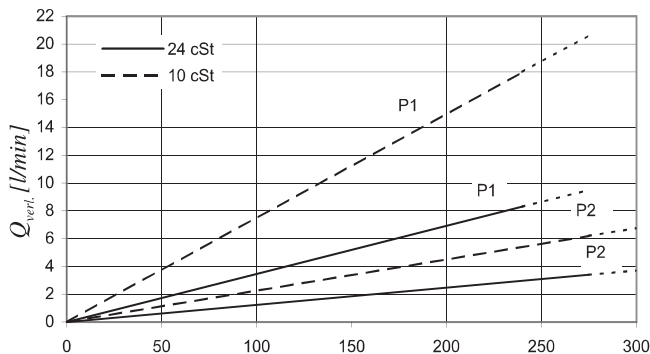

Bei $Q_{verl} > 50\%$ von Q_{theor} darf der Arbeitszyklus 5s nicht übersteigen.
Gesamtverlust aus der Summe beider Hubringe bei jeweiligem Betriebsdruck.

GERÄUSCHPEGEL (TYPISCH) - T67CB - 014 - B03

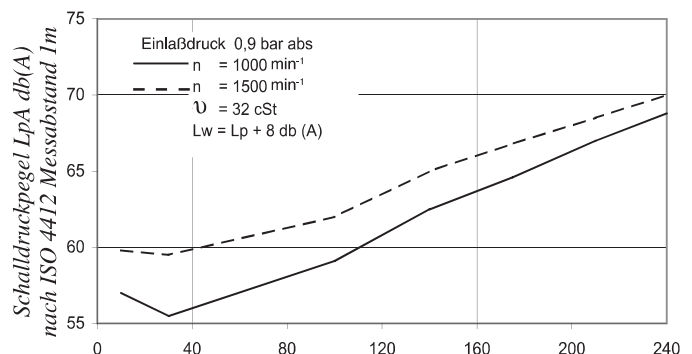

Kurve gilt bei gleichem Druck für P1 und P2.

LEISTUNGSVERLUST HYDRAULISCH-MECHANISCH (TYPISCH)

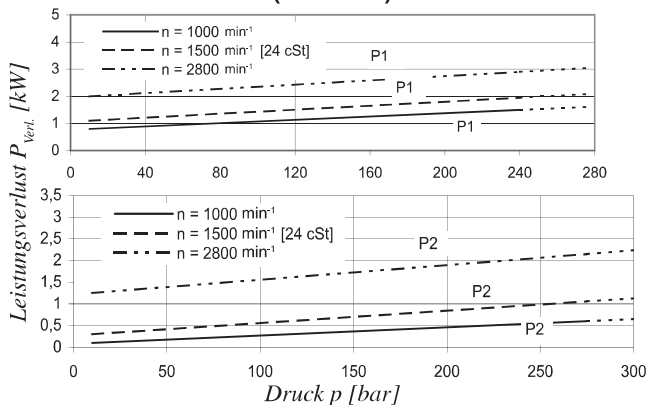

Gesamtverlust aus der Summe beider Hubringe bei jeweiligem Betriebsdruck.

ZULÄSSIGE WELLENBELASTUNG

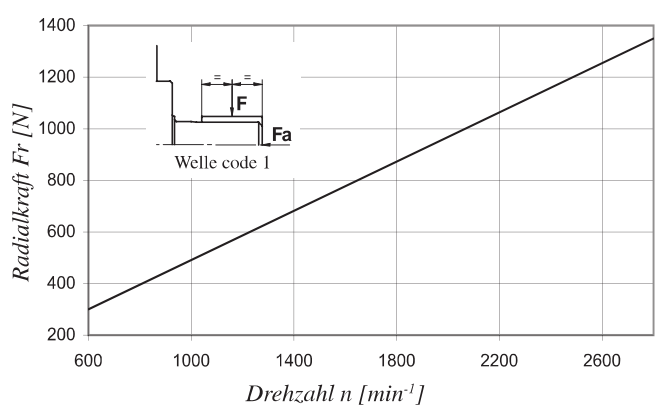

Max. zulässige Axialkraft $F_a = 800 \text{ N}$

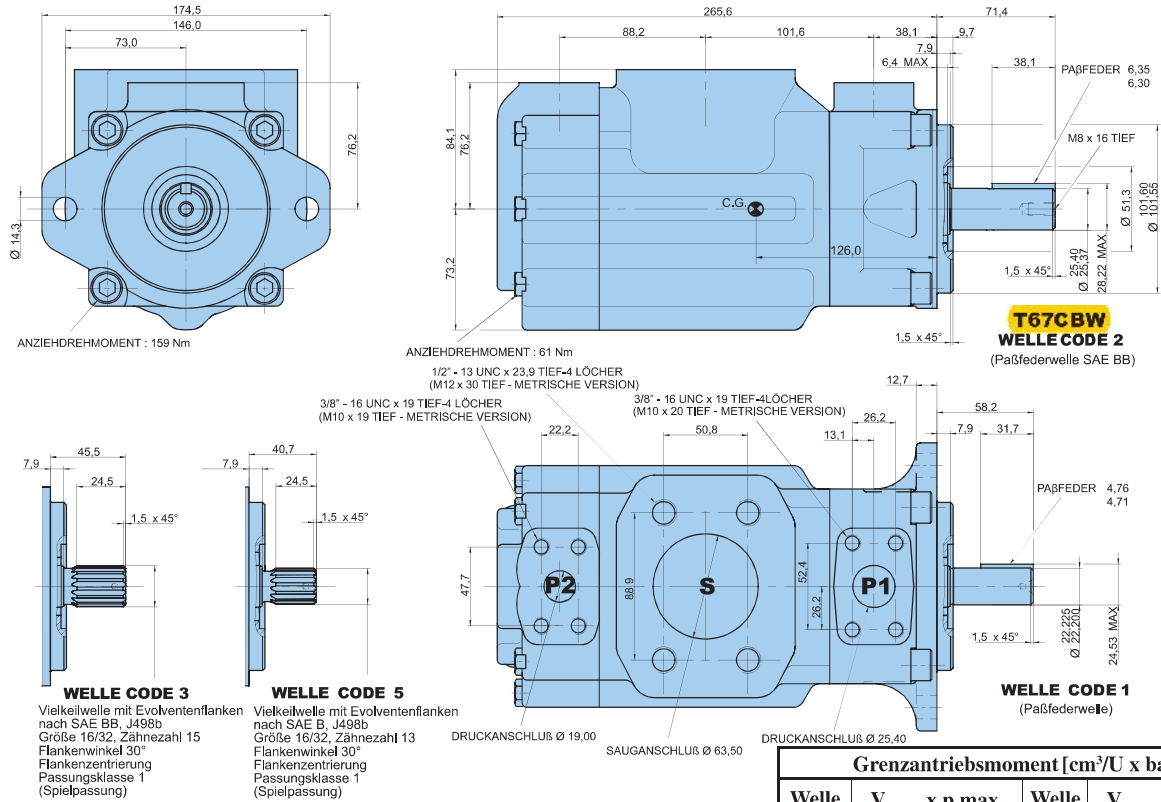

BETRIEBS - CHARAKTERISTIK - TYPISCH [24 cSt]

Druckanschluß	Hubring	Geometrisches Fördervolumen V _{geom.}	Förderstrom Q [l/min] bei n = 1500 min ⁻¹			Antriebsleistung P [kW] bei n = 1500 min ⁻¹		
			p = 0 bar	p = 140 bar	p = 275 bar	p = 7 bar	p = 140 bar	p = 275 bar
P1	003	10,8 cm³/U	16,2	11,2	*	1,3	5,3	*
	005	17,2 cm³/U	25,8	20,8	16,1	1,4	7,5	13,9
	006	21,3 cm³/U	31,9	26,9	22,2	1,5	8,9	16,8
	008	26,4 cm³/U	39,6	34,6	29,9	1,6	10,7	20,3
	010	34,1 cm³/U	51,1	46,1	41,4	1,7	13,4	25,6
	012	37,1 cm³/U	55,6	50,6	45,9	1,7	14,4	27,6
	014	46,0 cm³/U	69,0	64,0	59,3	1,9	17,6	33,7
	017	58,3 cm³/U	87,4	82,4	77,7	2,1	21,9	42,2
	020	63,8 cm³/U	95,7	90,7	86,0	2,2	23,8	46,0
	022	70,3 cm³/U	105,4	100,4	95,7	2,3	26,1	50,4
025	79,3 cm³/U	118,9	113,9	109,2	2,5	29,2	56,6	
028	88,8 cm³/U	133,2	128,2	125,8 ¹⁾	2,8	32,7	48,5 ¹⁾	
031	100,0 cm³/U	150,0	145,0	142,6 ¹⁾	2,8	36,5	54,4 ¹⁾	
P2			p = 0 bar	p = 140 bar	p = 300 bar	p = 7 bar	p = 140 bar	p = 300 bar
	B02	5,8 cm³/U	8,7	7,0	5,1	0,5	2,6	5,1
	B03	9,8 cm³/U	14,7	13,0	11,1	0,6	4,0	8,1
	B04	12,8 cm³/U	19,2	17,5	15,6	0,6	5,0	10,4
	B05	15,9 cm³/U	23,9	22,2	20,2	0,7	6,1	12,7
	B06	19,8 cm³/U	29,7	28,0	26,1	0,7	7,5	15,6
	B07	22,5 cm³/U	33,7	32,0	30,2	0,8	8,5	17,6
	B08	24,9 cm³/U	37,4	35,7	33,7	0,8	9,3	19,5
	B09	28,0 cm³/U	42,0	40,3	38,4	0,9	10,4	21,8
	B10	31,8 cm³/U	47,7	46,0	44,1	0,9	11,7	26,2
	B11	35,0 cm³/U	52,5	50,8	48,9	1,0	12,8	27,0
	B12	41,0 cm³/U	61,5	59,8	57,9	1,1	14,9	31,5
	B14	45,0 cm³/U	67,5	65,8	63,9	1,2	16,3	34,5
	B15	50,0 cm³/U	75,0	73,3	71,6 ²⁾	1,3	18,1	35,7 ²⁾

* Da Q_{vert.} > 50% von Q_{theor.} bitte Hubring 003 nicht mit 275 bar und 1500 min⁻¹ einsetzen.

¹⁾ 028 - 031 = 210 bar max. kurzzeitig. ²⁾ B15 = 280 bar max. kurzzeitig

T7BB/T7BBS

T6CC

T67CB

T7DB/T7DBS

T67DC

T7EB/T7EBS

T67EC

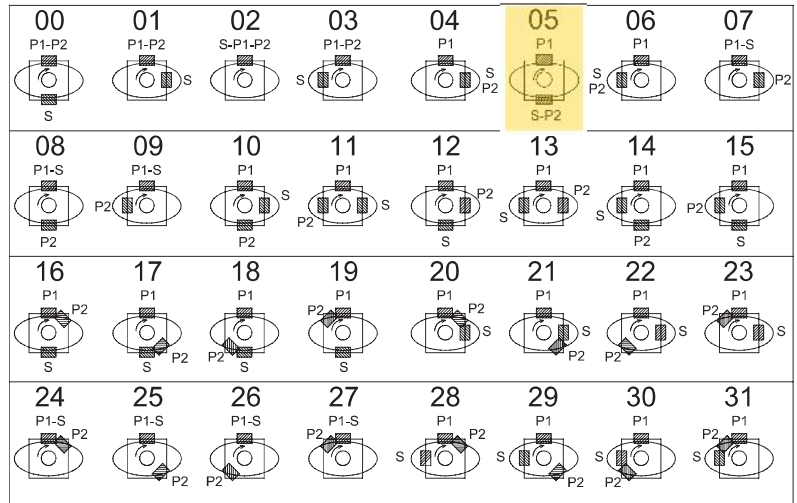

T7DD/T7DDS

T7ED/T7EDS

T7EE/T7EES

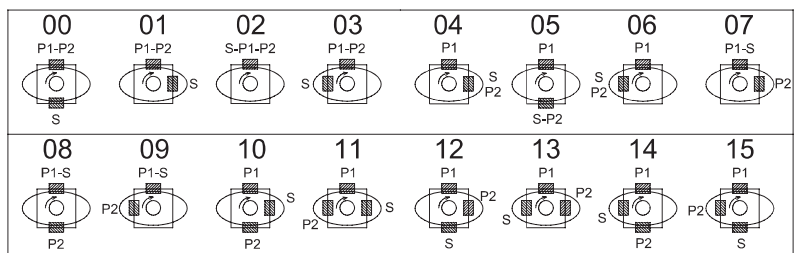

T7DBB/T7DBBS

T7DCB/T7DCBS

T7DCC/T7DCCS

T7DBB/T7DBBS

T67DDCS

T7EDB/T7EDBS

T67EDC/T67EDCS

T7EEC/T7EECS

