

4/3 and 4/2 Directional Spool Valves, ISO Size 02

$Q_{\max} = 25 \text{ l/min}$, $p_{\max} = 250 \text{ bar}$
Direct acting, solenoid operated
Series WEDC...



- For controlling the starting, stopping, and direction of a flow
- Manifold-mounting design, interface to ISO 4401-02-01
- Operated by DC or AC solenoids
- Very reliable functions and extremely stable
- With manual override
- All exposed parts with zinc-nickel plating
- High pressure wet-armature solenoids
- The slip-on coil can be rotated, and it can be replaced without opening the hydraulic envelope

1 Description

The WEDC-...-4... series of directional spool valves are solenoid operated, direct acting, manifold-mounting valves with a size 02 interface to ISO 4401-02-01. The main components of the valves are a steel body, either one or two solenoids, the control spool, and either one or two return springs. In the non-operated state, the return springs hold the control spool in the middle position or initial position. The control spool is operated by the DC or AC solenoids, which are of the oil-immersed type. The integral manual override

can be used to move the spool without energising the coil, for example during a power failure. These 4/3 and 4/2 directional valves are used in plant and machines to control the direction of a flow, and to stop the flow. All external parts of the valve are zinc-nickel plated to DIN 50 979 and are thus suitable for use in the harshest operating environments. The slip-on coils can be replaced without opening the hydraulic envelope and can be positioned at any angle through 360°.



2 Technical data

General characteristics		Description, value, unit
Designation		4/3 and 4/2 directional spool valves
Design		manifold mounting, direct acting, electrically operated
Mounting method		4 mounting holes for M5x40 mounting bolts (valve mounting bolts supplied with the valve)
Tightening torque		5.2 Nm ± 5 %
Size		size 02 interface to ISO 4401-02-01
Weight		- valve with one solenoid - valve with two solenoids
		0.90 kg 1.30 kg
Mounting attitude		unrestricted
Ambient temperature range		-25 °C ... +80 °C

Hydraulic characteristics		Description, value, unit
Maximum operating pressure		- ports A, B, P - port T
		250 bar 160 bar (static 250 bar)
Maximum flow rate		25 l/min
Flow direction		see table "Symbols / Spool types"

Hydraulic characteristics	Description, value, unit
Hydraulic fluid	HL and HLP mineral oil to DIN 51 524; HEES biodegradable fluids; for other fluids, please consult BUCHER
Hydraulic fluid temperature range	-25 °C ... +80 °C
Viscosity range	10...500 mm ² /s (cSt), recommended 15...250 mm ² /s (cSt)
Minimum fluid cleanliness Cleanliness class to ISO 4406 : 1999	class 20/18/15
Electrical characteristics	Description, value, unit
Supply voltage	12 V DC, 24 V DC / 115 V AC, 230 V AC (50 ... 60 Hz)
Supply voltage tolerance	± 10 %
Nominal power consumption	V DC = 27 W / V AC = 25 W
Switching time	15 ... 80 ms (energising) 10 ... 40 ms (deenergising) Depending on pressure, flow rate and viscosity as well as dwell time under pressure, the switching times may vary from the the stated values.
Relative duty cycle	100 %
Protection class to ISO 20 653 / EN 60 529	IP 65 / IP 67 / IP 69K, see "Ordering code" (with appropriate mating connector and proper fitting and sealing)
Electrical connection	3-pin square plug to ISO 4400 / DIN 43 650 (standard) for other connectors, see "Ordering code"

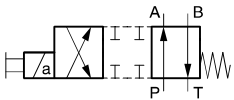
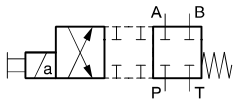
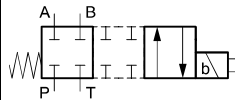
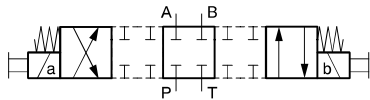
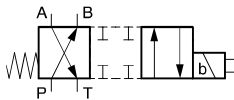
3 Symbols / Spool types

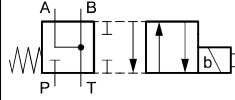
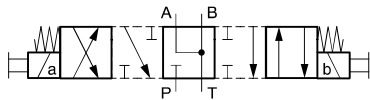
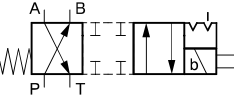
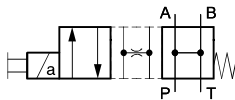
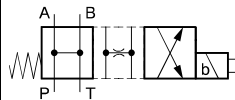
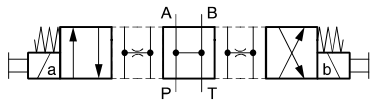
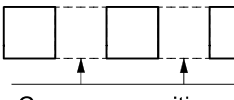
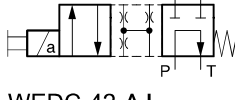
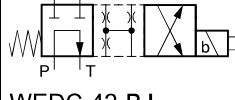
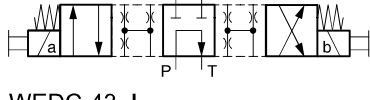
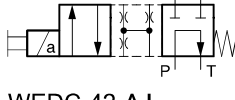
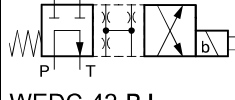
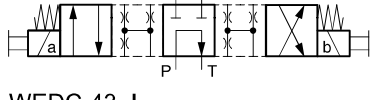
4/2 functions	4/2 functions with 4/3 spool types	4/2 functions with 4/3 spool types	4/3 functions
			
WEDC-42-A...	WEDC-42-AD...	WEDC-42-BD...	WEDC-43-D...
			
WEDC-42-B...	WEDC-42-AG...	WEDC-42-BG...	WEDC-43-G...
			
WEDC-42-C...	WEDC-42-AH...	WEDC-42-BH...	WEDC-43-H...
			
Crossover positions	WEDC-42-AF...	WEDC-42-BF...	WEDC-43-F...
			
	WEDC-42-AJ...	WEDC-42-BJ...	WEDC-43-J...

4 Performance graphs

$\Delta p = f(Q)$ Pressure drop - Flow rate characteristic
A / B / C spool

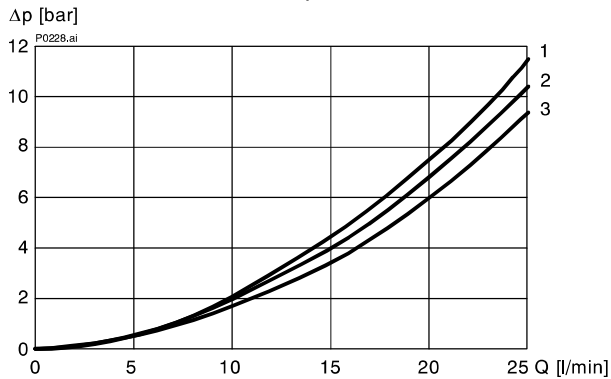

$\Delta p = f(Q)$ Pressure drop - Flow rate characteristic
D spool

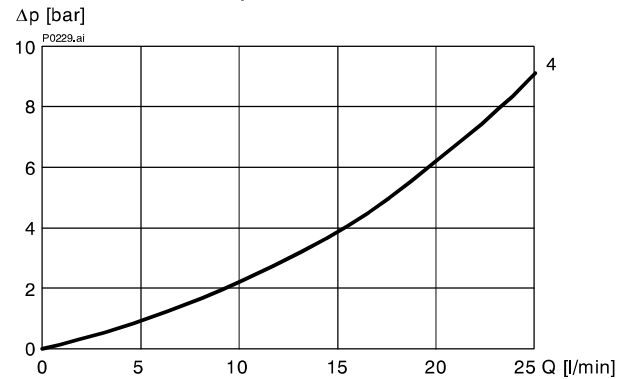

$\Delta p = f(Q)$ Pressure drop - Flow rate characteristic
G spool

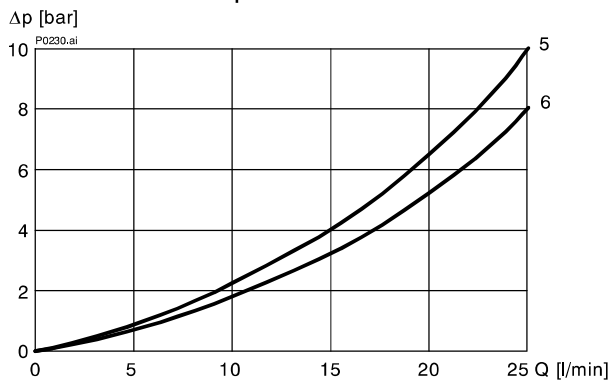

$\Delta p = f(Q)$ Pressure drop - Flow rate characteristic
H / J spool

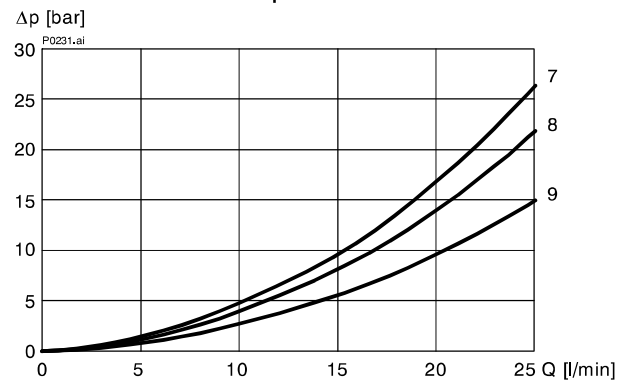

$\Delta p = f(Q)$ Pressure drop - Flow rate characteristic
F spool ¹⁾ (Q_{max} 20 l/min)

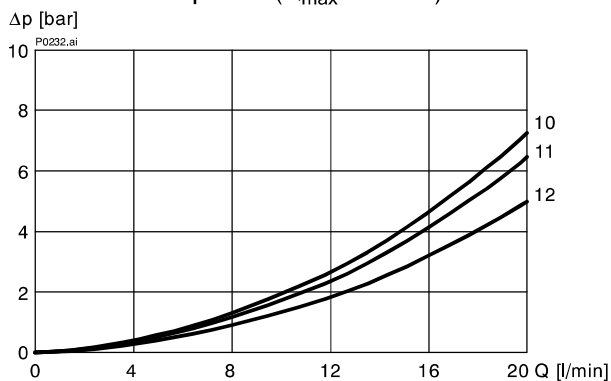

IMPORTANT!

¹⁾ F spool (F / AF / BF):

The maximum flow rate of 20 l/min refers to symmetrical flow through the valve.
For differential cylinders (e.g. $i = 1.46$), the maximum flow rate is restricted to 10 l/min.

Operated position

Spool type	Flow direction			
	P - A	P - B	A - T	B - T
A / C	3	2	1	2
B	2	3	2	1
D / AD / BD	4	4	4	4
G / AG / BG	5	5	6	6
H / AH / BH	8	8	7	7
J / AJ / BJ	7	7	7	7
F / AF / BF ¹⁾	12	12	10	10

Mid-position (de-energised position)

Spool type	Flow direction				
	P - A	P - B	B - T	A - T	P - T
H / AH / BH	-	-	8	8	9
J / AJ / BJ	-	-	-	-	9
F / AF / BF ¹⁾	11	11	-	-	-

5 Dimensions & sectional view

4/3 spool valve (spring centred)

4/2 spool valve (pulse signal, detented)

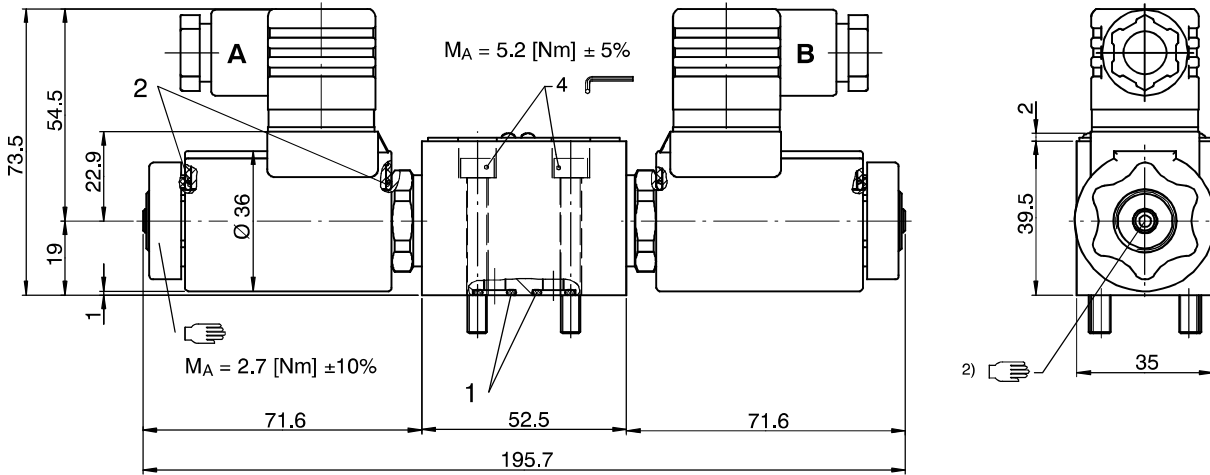

4/2 spool valve (1-solenoid model, A or B side)

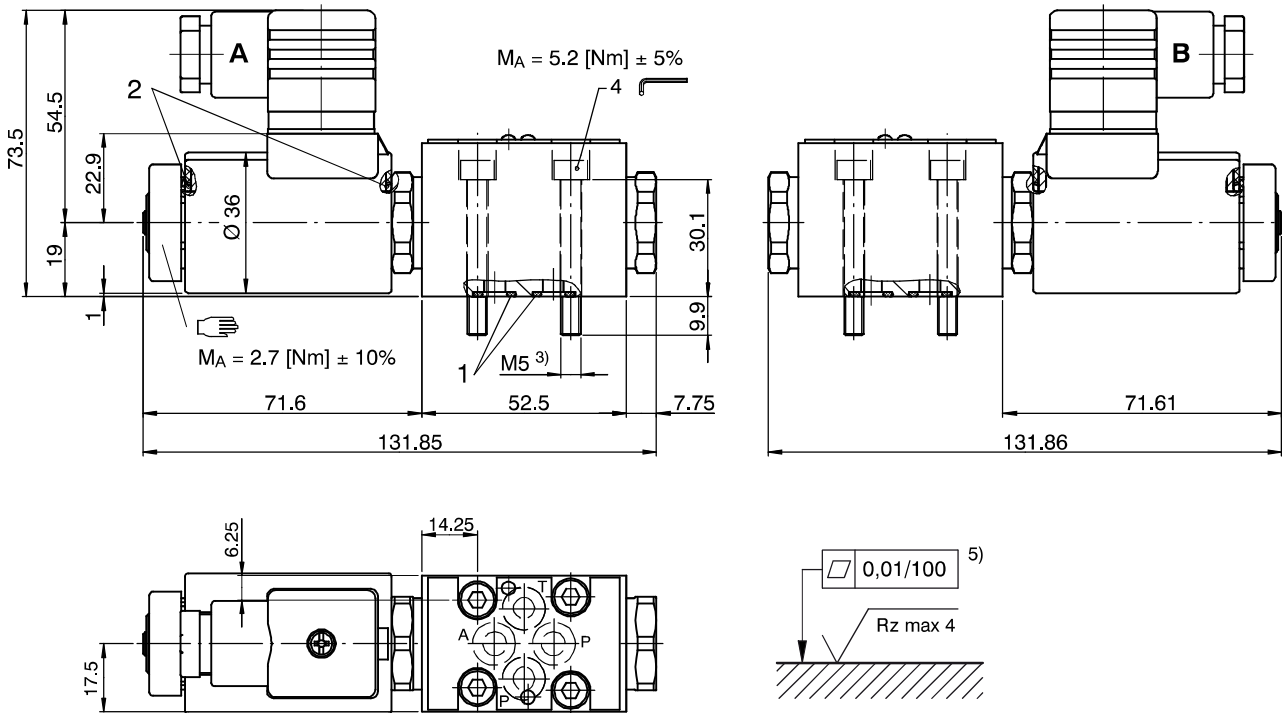

Seal kit NBR no. DS-322-N ⁴⁾

Item	Qty.	Description
1	4	O-ring no. 011 Ø 7,65 x 1,78 N90
2	4	O-ring Ø 16,00 x 2,00 FKM



IMPORTANT!

- 2) With manual override
- 3) Valve mounting bolts M5x40 (included in the delivery)
- 4) Seal kit with FKM (Viton) seals no. DS-322-V
- 5) Required surface finish on the mounting face (valve pad)

6 Installation information



ATTENTION!

Only qualified personnel with mechanical skills may carry out any maintenance work. Generally, the only work that should ever be undertaken is to check, and possibly replace, the seals. When changing seals, oil or grease the new seals thoroughly before fitting them.



IMPORTANT!

When fitting the valves, use the specified tightening torque for the mounting bolts. No adjustments are necessary, since the cartridges are set in the factory.

7 Ordering code

WEDC - 43 - D - 4 - 1 12VDC JT

Ex.

W	E	D	C	43	D	4	-	1	24	D	-
---	---	---	---	----	---	---	---	---	----	---	---

- W** = directional valve
- E** = solenoid operated
- D** = direct acting
- A ... Q = standard model - see relevant data sheets
- Z ... R = special features - please consult BUCHER
- 42 = 4/2 function (2 operating positions)
- 43** = 4/3 function (3 operating positions)
- ... = spool type / symbol to section 3 – page 2 (e.g. AD, D, etc.)
- 4 = ISO size 02 interface
- (blank) = NBR (Nitrile) seals (standard)
- V = FKM (Viton) seals
(special seals - please contact BUCHER)
- 1 ... 9 = design stage (omit when ordering new units)
- ... = voltage e.g. 24 (24 V)
- D** = current DC
- A = current AC
- (blank)** = ISO 4400 / DIN 43 650 connection with mating plug (standard, IP 65)
- M100 = ISO 4400 / DIN 43 650 connection without mating plug
- C = Kostal plug connection (IP 65)
- JT** = Junior Timer radial plug connection (with protection diode, IP65)
- IT = Junior Timer axial plug connection (with protection diode, IP65)
- D = Deutsch plug connection DT04-2P (IP 67/69K)
- DT = Deutsch plug connection DT04-2P (with protection diode, IP 67/69K)
- S = AMP Superseal 1.5 (IP67) / Metri-Pack 150 (IP65) plug connection
- F = flying leads (500 mm)

} mating plug not supplied

8 Related data sheets

Reference	(Old no.)	Description
400-P-030101	(i-30)	Size 02 interface to ISO 4401-02-01
400-P-120110	(W-2.141)	Coils for screw-in cartridge valves

info.ch@bucherhydraulics.com

www.bucherhydraulics.com

© 2016 by Bucher Hydraulics AG Frutigen, CH-3714 Frutigen

All rights reserved.

Data is provided for the purpose of product description only, and must not be construed as warranted characteristics in the legal sense. The information does not relieve users from the duty of conducting their own evaluations and tests. Because the products are subject to continual improvement, we reserve the right to amend the product specifications contained in this catalogue.

Classification: 430.300.-.315.305.300