



Technical Information

- CV** Check Valves
- SH** Shuttle Valves
- LM** Load/Motor Controls
- FC** Flow Controls
- PC** Pressure Controls
- LE** Logic Elements
- DC** Directional Controls
- MV** Manual Valves
- SV** Solenoid Valves
- PV** Proportional Valves
- CE** Coils & Electronics
- BC** Bore & Cavities
- TD** Technical Data

General Description

3-Way Spool Valves. For additional information see Technical Tips on pages SV1-SV6.



Features

- High flow capacity with reduced space requirements
- Standard valve bodies and common cavities
- One piece encapsulated coils with minimal amperage draw
- Manual overrides, seal variations and other options available
- No dynamic seals
- Variety of coil terminations
- Polyurethane "D"-Ring eliminates need for backup rings
- Nylon inserted jam-nut provides secure holding in high vibration applications
- All external parts zinc plated

Specifications

Rated Flow	DSL083A	N.O.	13.2 LPM (3.5 GPM)
		N.C.	8.4 LPM (2.25 GPM)
		Selector	8.4 LPM (2.25 GPM)
	DSL083B	N.C.	15.0 LPM (4.0 GPM)
		Selector	15.0 LPM (4.0 GPM)
	DSL083C	N.O.	15.0 LPM (4.0 GPM)
	DSL083N	N.O.	12.3 LPM (3.25 GPM)
		Selector	15.0 LPM (4.0 GPM)
	Maximum Inlet Pressure	250 Bar (3600 PSI)	
Leakage at 150 SSU (32 cSt)	120 cc/min. (7.5 in ³ /min.) at 250 Bar (3600 PSI)		
	DSL083B - 180 cc/min. (11 in ³ /min.)		
	DSL083N - 180 cc/min. (11 in ³ /min.)		
Minimum Operating Voltage	85% of rated voltage at 20°C (72°F).		
Response Time	50 ms		
Cartridge Material	All parts steel. All operating parts hardened steel.		
Operating Temp. Range/Seals	-45°C to +93.3°C ("D"-Ring) (-50°F to +200°F) -31.7°C to +121.1°C (Fluorocarbon) (-25°F to +250°F)		
Fluid Compatibility/Viscosity	Mineral-based or synthetic with lubricating properties at viscosities of 45 to 2000 SSU (6 to 420 cSt)		
Filtration	ISO Code 16/13, SAE Class 4 or better		
Approx. Weight	.13 kg (.28 lbs.)		
Cavity	C08-3 (See BC Section for more details)		
Form Tool	Rougher	NFT08-3R	
	Finisher	NFT08-3F	

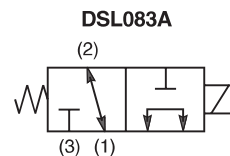

Construction/Symbols

DSL083A

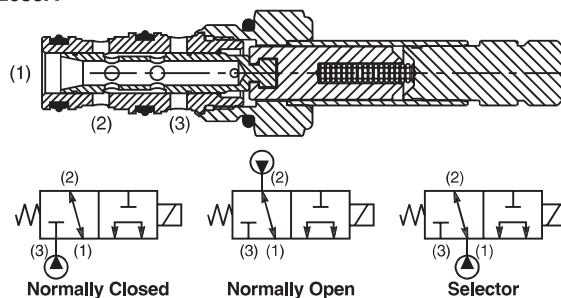

DSL083B

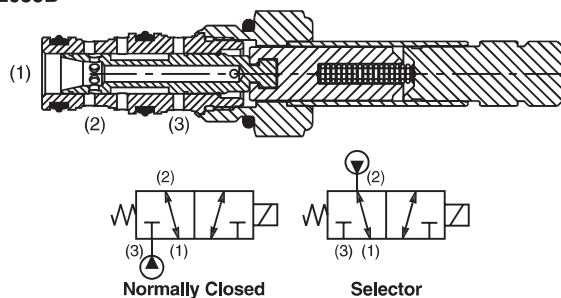

DSL083C

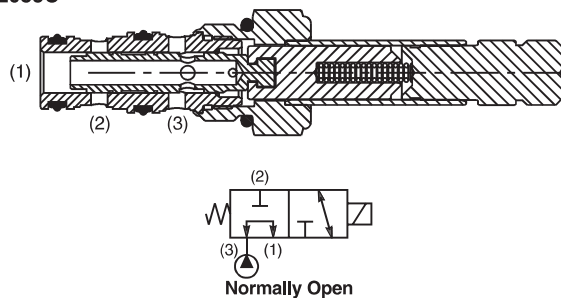

DSL083N

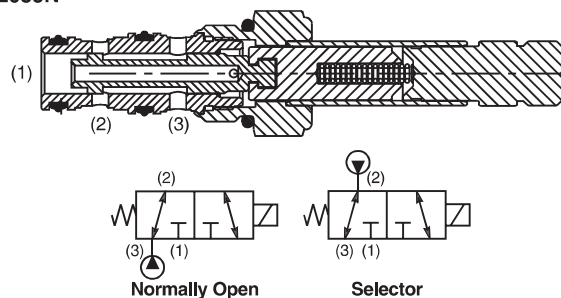

Dimensions Millimeters (Inches)

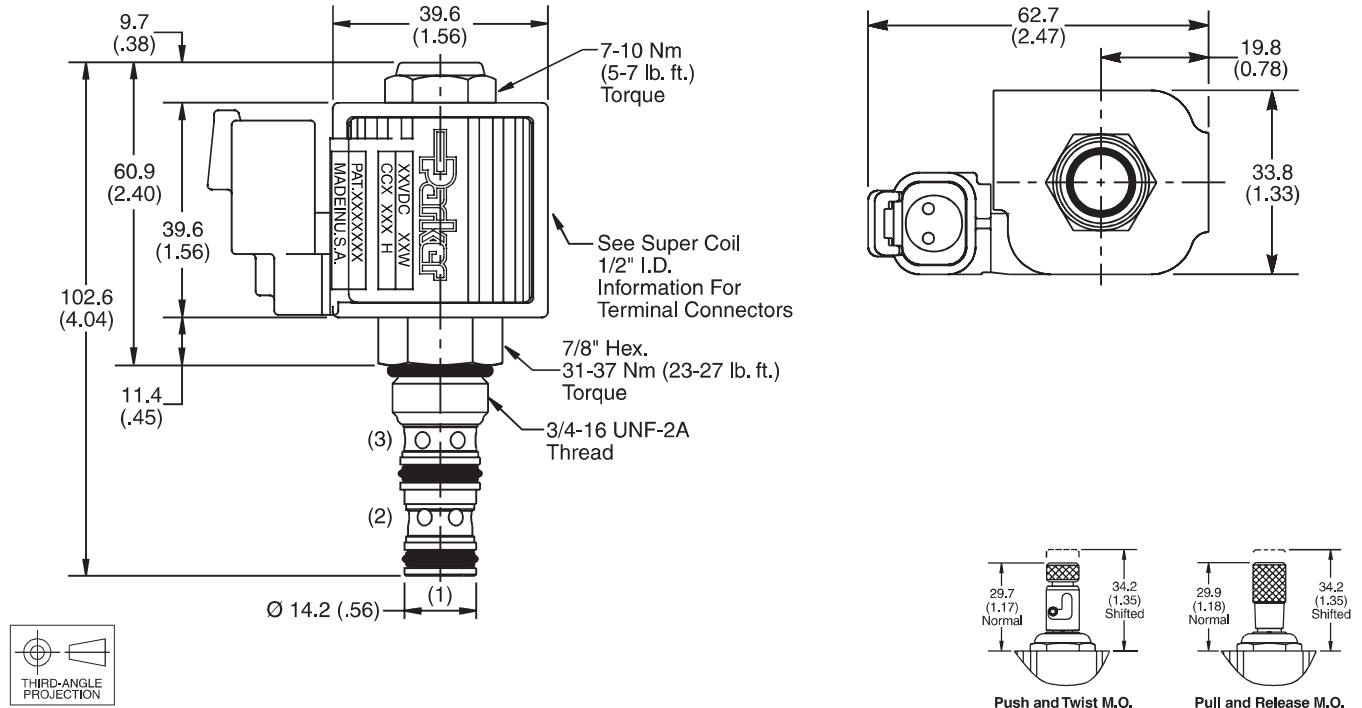

Ordering Information

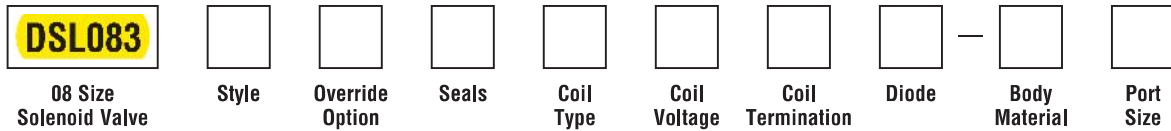

Code	Style
A	
B	
C	
N	

Code	Override Options
Omit	None
P	Pull & Release
T	Push & Twist

Code	Seals / Kit No.
Omit	"D"-Ring / (SK08-3)
N	Nitrile / (SK08-3N)
V	Fluorocarbon / (SK08-3V)

Code	Coil Type
Omit	Without Coil
SP*	Super Coil - 19 Watts

*Recommended

Code	Coil Voltage
Omit	Without Coil
D012	12 VDC
D024	24 VDC
A120	120/110 VAC, 60/50 Hz
A240	240/220 VAC, 60/50 Hz

SP* Coil	Coil Termination
Omit	Without Coil
C	Conduit With Leads
D	DIN Plug Face
A	Amp Jr. Timer†
S	Dual Spade†
L	Dual Lead Wire†
LS	Sealed Lead Wire†
H	Molded Deutsch†

*Recommended
 †DC Only

Code	Diode
Omit	None
R	Diode

Code	Body Material
Omit	Steel
A	Aluminum

Code	Port Size	Body Part No.
Omit	Cartridge Only	
4P	1/4" NPTF	(B08-3-*4P)
4T	SAE-4	(B08-3-*4T)
6T	SAE-6	(B08-3-*6T)
6B	3/8" BSPG	(B08-3-*6B)

* Add "A" for aluminum, omit for steel.