

Valves type MK are throttle / check valves in which flow is dependent on temperature and pressure drop at the throttle point. They are designed to control the fluid flow rate in one direction and allow free flow in the opposite direction. The valves may be used in hydraulic systems, when working resistance is constant or change in speed at changing load is of no importance. The valves are for direct in-line mounting in any position by means of couplings.

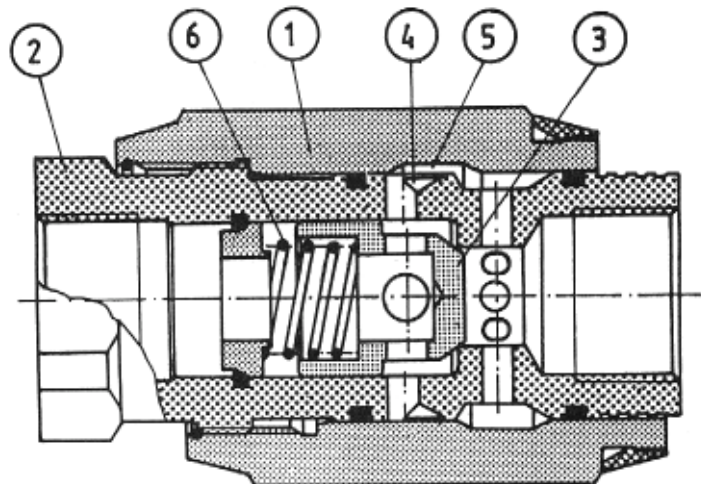

### DESCRIPTION OF OPERATION



When there is a flow in throttle direction, fluid reaches the rear side of the poppet 3 of the check valve which is pushed onto its seat in the housing 2 by the spring 6. The fluid flows to the variable orifice 4 through the side bores in the poppet 3. Throttling takes place between the housing 2 and adjustable sleeve 1. With flow in the opposite direction, the fluid acts on the face surface of the poppet 3. The poppet 3 is lifted from its seat and the fluid flows freely through the valve. Simultaneously, part of the fluid getting through the ring slot 5 creates the desired effect as its self-cleaning.

**Note :**

The valve install in hydraulic system to take hold on hexagon of housing item 2.

It isn't to allow for turn up the valve by nut item 1.

Do not adjust under pressure.

## TECHNICAL DATA

Hydraulic fluid	Mineral oil or phosphate ester
Nominal fluid viscosity	37 mm <sup>2</sup> /s at the temperature of 328 K
Viscosity range	2.8 to 380 mm <sup>2</sup> /s
Optimum working temperature( fluid in a tank )	313 - 328 K
Fluid temperature range	243 - 343 K
Filtration	up to 16 μm
Maximum operating pressure	31.5 MPa
Cracking pressure	0.05 MPa

## OVERALL DIMENSIONS

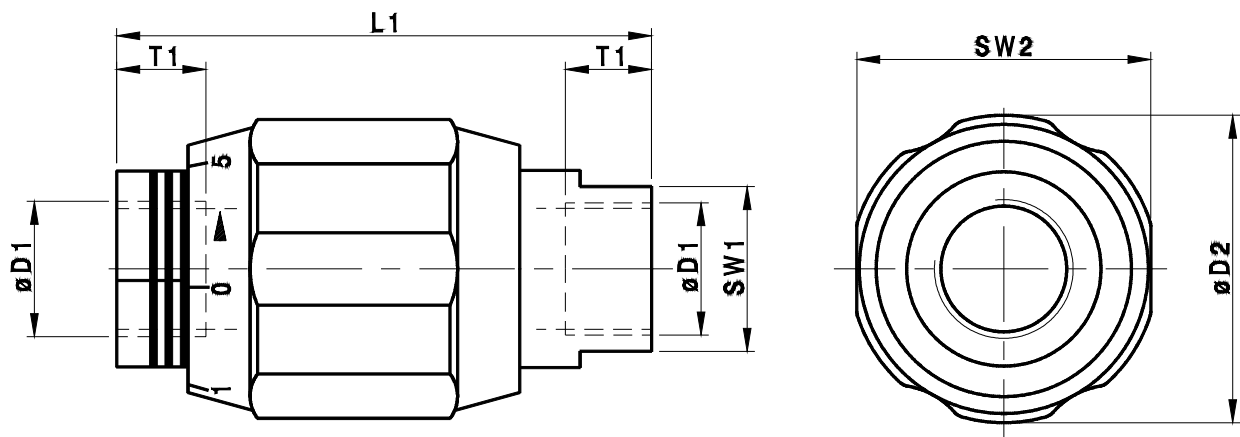

Size	D1	D2	L	SW1	SW2	T1	Weight
6	G 1/4	34	65	22	32	12	0,3
8	G 3/8	38	65	24	36	12	0,4
10	G 1/2	48	80	30	46	14	0,7
15	G 3/4	58	100	41	55	16	1,1
<b>20</b>	<b>G1</b>	<b>72</b>	<b>110</b>	<b>46</b>	<b>70</b>	<b>18</b>	<b>1,9</b>
25	G1 1/4	87	130	55	85	20	3,2
30	G1 1/2	93	150	60	80	22	4,1

**PERFORMANCE CURVES**, measured at  $v = 41 \text{ mm}^2/\text{s}$  and  $T = 323 \text{ K}$

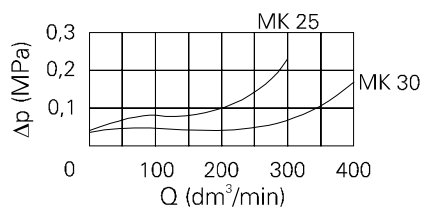
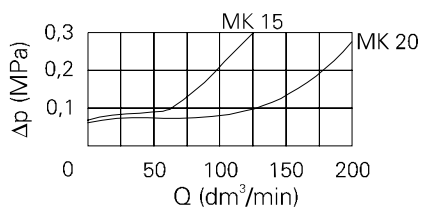
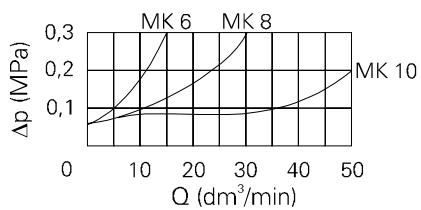

$\Delta p - Q$  curve - via open check valve with closed throttle

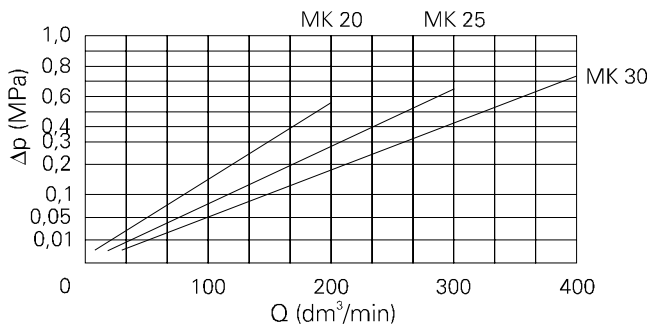
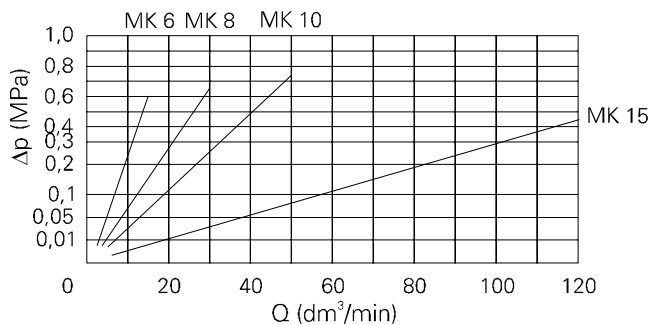

$\Delta p - Q$  curve - via closed check valve with open throttle

**SCHEMES**

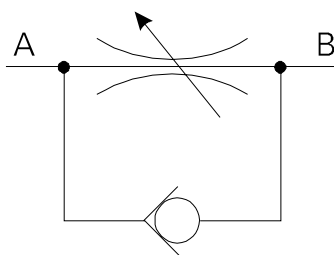

Graphical symbol

## HOW TO ORDER

Orders coded in the way showed below should be forwarded to the manufacturer.

<b>MK</b>		<b>G</b>		*
<b>Nominal size</b>				Further requirements in clear text ( to be agreed upon with the manufacturer )
Size 6	= 6			
Size 8	= 8			
Size 10	= 10			
Size 15	= 15			
Size 20	= <b>20</b>			
Size 25	= 25			
Size 30	= 30			
<b>Mounting</b>				
Direct in-line mounting	= G			
<b>Series number</b>				
13	= 13			
(10 - 19) - installation and connection dimensions remain unchanged				

Coding example : MK 6 G 13

### NOTES :

PONAR WADOWICE S.A.  
ul. Wojska Polskiego 29  
34-100 Wadowice  
tel. 033/ 823 39 43, 823 30 41  
fax 033/ 873 48 80  
e-mail: ponar@ponar-wadowice.pl

