

Types and ordering codes

Coil type	Voltage	Connectors					
		ISO4400	Deutsch DT	AMP JPT	Packard Weatherpack	Packard Metri-pack	Flying leads (without conn.)
BER	10 VDC	4SLE001000A	-	-	-	-	-
	12 VDC	4SLE001200A	4SLE001201A ⁽⁵⁾	4SLE001203A ⁽⁵⁾	4SLE001210A ⁽²⁾	4SLE001214A ⁽²⁾	4SLE001207A
		4SLE001217A ⁽³⁾	4SLE001209A ⁽³⁻⁵⁾	4SLE001211A ⁽³⁻⁵⁾	-	-	-
		-	4SLE001202A ⁽⁶⁾	-	-	-	-
		-	4SLE001216A ⁽³⁻⁶⁾	-	-	-	-
	14 VDC	-	4SLE001400A ⁽⁶⁾	4SLE001403A ⁽³⁻⁵⁾	-	-	-
	24 VDC	4SLE002400A	4SLE001401A ⁽³⁻⁶⁾	-	-	-	-
		4SLE002408A ⁽³⁾	4SLE001402A ⁽³⁻⁵⁾	4SLE002403A ⁽⁵⁾	-	-	4SLE002404A
28 VDC	-	4SLE002407A ⁽³⁻⁵⁾	-	-	-	-	
48 VDC	4SLE002400A ⁽¹⁾	4SLE002402A ⁽⁶⁾	4SLE002800A ⁽⁵⁾	-	-	-	
110VDC	4SLE004800A	-	-	-	-	-	
220 VDC	4SLE311000A ⁽¹⁾	-	-	-	-	-	
BT	10 VDC	4SL3000100	-	-	-	-	-
	12 VDC	4SL3000120	4SL3000130 ⁽⁶⁾	4SL3000122 ⁽⁵⁾	4SL3000124 ⁽²⁾	4SL3000127 ⁽²⁾	4SL300012C
		4SL3000126 ⁽⁴⁾	4SL3000134 ⁽³⁻⁶⁾	4SL3001200 ⁽³⁻⁵⁾	-	-	-
		-	4SL3000128 ⁽²⁾	-	-	-	-
	24 VDC	4SL3000240	4SL3000249 ⁽⁶⁾	4SL3000248 ⁽⁵⁾	-	-	4SL3000246
	26 VDC	4SL3030240 ⁽¹⁾	4SL300024C ⁽³⁻⁶⁾	-	-	-	-
	48 VDC	4SL3000260	-	-	-	-	-
	110 VDC	4SL3000480	-	-	-	-	-
220 VDC	4SL3030480 ⁽¹⁾	-	-	-	-	-	
Mating connectors	Standard	4CN1009995	5CON140031	5CON003	5CON001	5CON017	-
	With rectifier	4CN3010240	-	-	-	-	-
With rectifier	24VDC	4CN3010480	-	-	-	-	-
	110VDC	4CN3011100	-	-	-	-	-
	220VDC	4CN3012200	-	-	-	-	-

NOTES: ⁽¹⁾ supply with AC and use only with rectifier connector - ⁽²⁾ with flying leads - ⁽³⁾ with bidirectional diode - ⁽⁴⁾ with unidirectional diode
⁽⁵⁾ integrated perpendicular type - ⁽⁶⁾ integrated parallel type

Dimensional data and features

BER type

ISO4400 connector

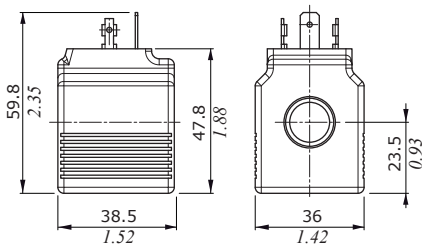

AMP JPT connector

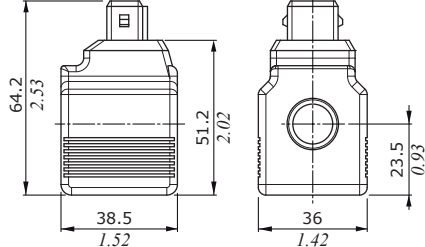

Features

- Nominal voltage tolerance : $\pm 10\%$
- Power rating : 19.2 W - 12/24 VDC
48 RAC
: 19.1 W - 28 VDC
: 19 W - 10/14/48/110/
220 VDC
24/110/220 RAC
- Max. operating current . . : 1.90 A - 10 VDC
: 1.60 A - 12 VDC
: 1.36 A - 14 VDC
: 0.80 A - 24 VDC
: 0.68 A - 28 VDC
: 0.40 A - 48 VDC
: 0.17 A - 110 VDC
: 0.09 A - 220 VDC
: 0.89 A - 24 RAC
: 0.45 A - 48 RAC
: 0.19 A - 110 RAC
: 0.09 A - 220 RAC
- Coil insulation : Class H (180°C - 356°F)
- Weather protection : IP65 - ISO4400
: IP69K - Deutsch DT
: IP65 - AMP JPT
: IP67 - Weatherpack
: IP67 - Metri-pack
- Insertion : 100%

DEUTSCH DT04 connector
(parallel type)

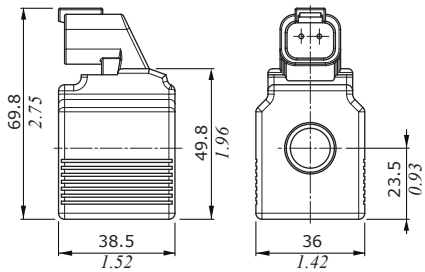

DEUTSCH DT04 connector
(perpendicular type)

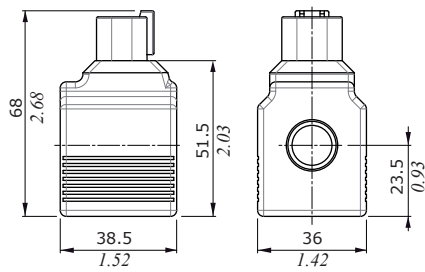

Flying leads

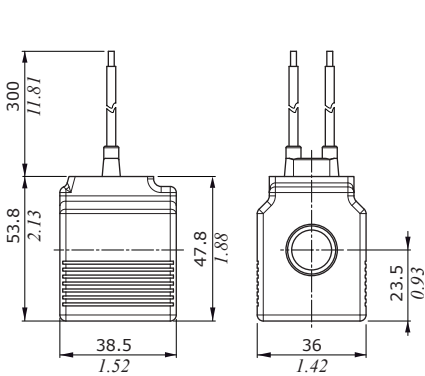

Flying leads with DEUTSCH DT04 connector

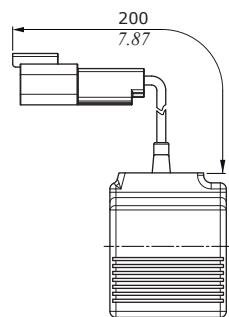

Flying leads with PACKARD WEATHER-PACK connector

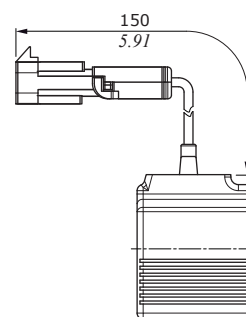

Flying leads with PACKARD METRI-PACK connector

