

4/2 Cartridge Spool Valve, Size 5

$Q_{max} = 30 \text{ l/min}$, $p_{max} = 250 \text{ bar}$
direct acting, with solenoid operation
Series WK42A...



- High flow rates
- High pressure wet-armature solenoids
- Coils can be changed without opening hydraulic envelope
- All exposed parts with zinc-nickel plating
- 3/4-16 UNF mounting thread
- BUCHER cavity type AN
- Line mounting body (G 3/8") is available
- Can be fitted in "VV" stacking assemblies

1. Description

The WK42A ... series of 4/2 directional valves are solenoid actuated screw-in cartridges, nominal size 5 mm. They are direct acting, spool type units. The range is based on the 3/4-16 UNF mounting thread. The straightforward design delivers an outstanding price/ performance ratio and good Δp -Q characteristics. All exposed steel parts are zinc-plated and the valves are suitable for use in the harshest operating environments. The core tube/slip-on coil design allows coils to be changed without opening the hydraulic envelope, even when the valve is under pressure. Coils can

be secured at any angle through 360° and are available with the common electrical connectors. The valves are designed to be fitted with a normal 24 A/F OE spanner in BUCHER cavity type AN but can also be installed in some other makes of 3/4-16 UNF cavity. For customers who manufacture their own manifold blocks, we offer form tool sets for sale or hire. The G 3/8" threaded body GANA is available for line mounting applications. In combination with other cartridges from series WK..-6 and series W1.. the valves can be fitting in BUCHER "VV" stacking assemblies.

2. Symbols

WK42A KN12 NV5-1

WK42ANA5
WK42AEA5

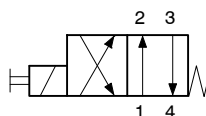

3. Characteristics

Type		4/2 cartridge spool valve
Design		direct acting, with solenoid operation
Mounting method		screw-in cartridge 3/4-16 UNF
Size		nominal size 5, cavity type AN
Mass	kg	0.40
Mounting attitude		unrestricted
Flow direction		see symbols
Operating pressure	bar	to 250 in 1, 2, 3 and 4
Flow rate Q max.	l/min	30
Hydraulic fluid		HL and HLP mineral oil to DIN 51 524 for other fluids, please contact BUCHER
Hydraulic fluid temperature range	°C	-25 ... +80
Ambient temperature range	°C	-25 ... +50
Viscosity range	cSt	10 ... 500 mm ² /s, recommended 15 ... 250 mm ² /s
Minimum fluid cleanliness		20/18/15 to ISO 4406 : 1999
Standard voltages	VAC VDC	115, 230 50 ... 60 Hz 12, 24
Nom. voltage tolerance	%	± 10

Nominal power consumption	W	VAC: optionally 17 or 25 VDC: optionally 17 or 27
Duty cycle	% ED	100 % energisation
Enclosure protection		IP 65 to DIN 40050
Electrical connection		3-pin square plug to DIN 43 650 / ISO 4400 (standard) for other connectors, see "Ordering code"

4. Performance characteristics

Oil viscosity 33 cSt solenoid at steady-state temperature, 10% under-voltage

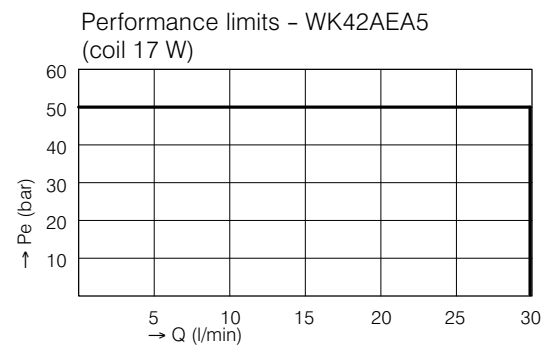
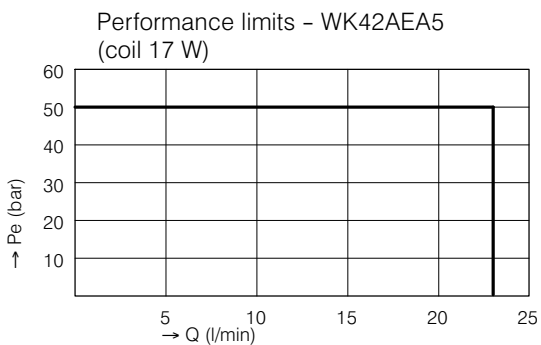
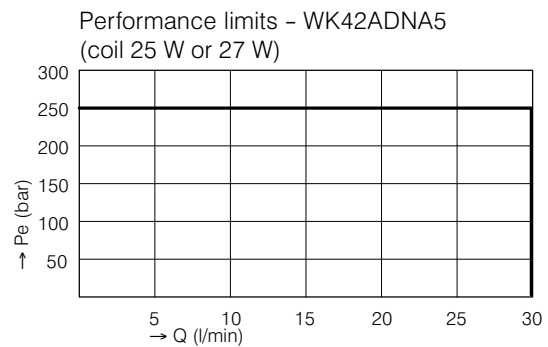
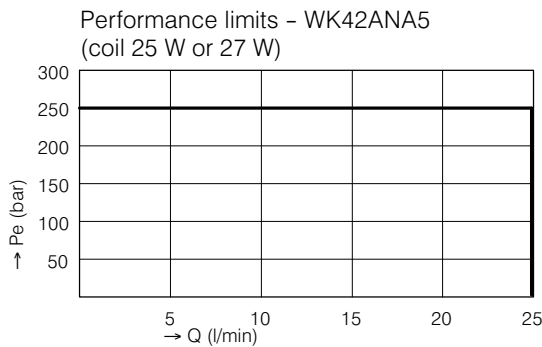
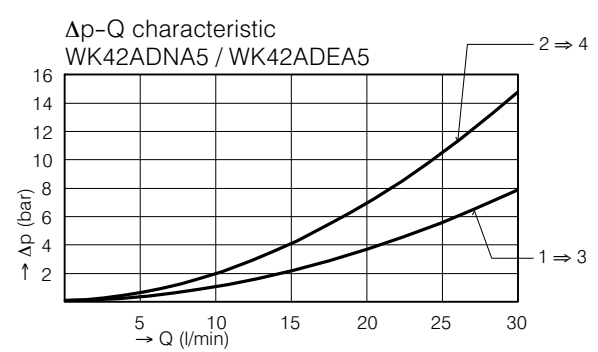
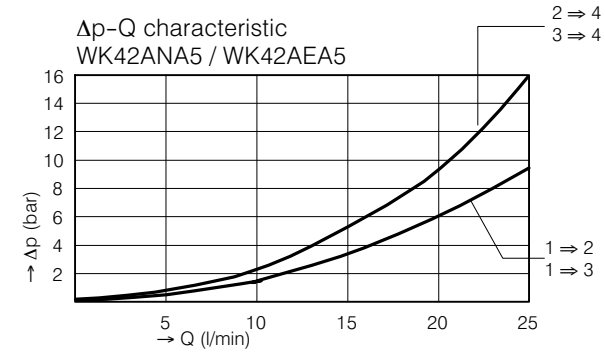

Switching times	WK42ANA5 27/25 W	WK42AEA5 17 W	WK42ADNA5 27/25 W	WK42ADEA5 17 W
Solenoid ON	32 ... 80 ms	45 ... 80 ms	32 ... 80 ms	45 ... 80 ms
Solenoid OFF	15 ... 60 ms	20 ... 45 ms	15 ... 60 ms	20 ... 45 ms

These times are strongly influenced by fluid pressure, flow rate and viscosity.

5. Dimensions

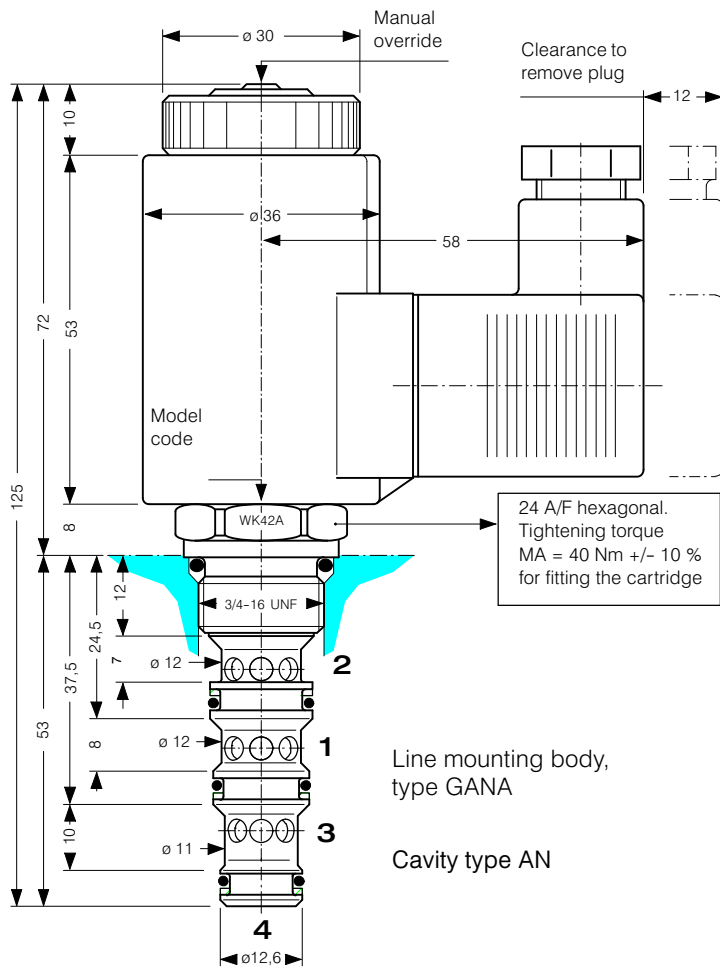

6. Schematic section

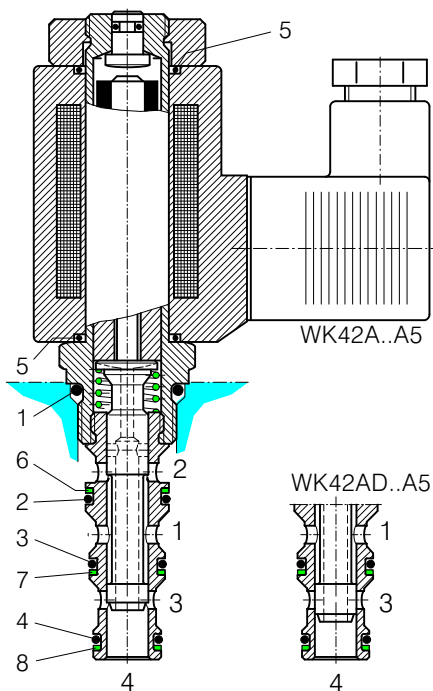

Seal kit no. DS-248-N, comprising:

Itm.	Qty.	Description	Dimension
1	1	O-ring no. 017	Ø 17,17 x 1,78 N90
2	1	O-ring no. 014	Ø 12,42 x 1,78 N90
3	1	O-ring no. 013	Ø 10,82 x 1,78 N90
4	1	O-ring no. 012	Ø 9,25 x 1,78 N90
5	2	O-ring	Ø 16,00 x 2,00 Viton
6	1	Backup ring	Ø 7,8 x 1,45 x 1,0 FI0751
7	1	Backup ring	Ø 9,4 x 1,45 x 1,0 FI0751
8	1	Backup ring	Ø 10,7 x 1,45 x 1,0 FI0751

7. Installation and servicing

All installation and servicing must be carried out with care, and by qualified personnel only. When changing seals, the new seals must be thoroughly oiled or greased before they

are fitted. Use the correct tightening torque when fitting the cartridge.

8. Model code key

- W** = directional valve
- K** = spool type, direct acting
- 42A** = 4/2 function, A spool (see symbol)
- 42AD** = 4/2 function, AD spool (see symbol)
- N** = electrically operated, V DC = 27 W / V AC = 25 W
- E** = electrically operated, V DC = 17 W / V AC = 17 W
- A ... Q** = standard model per current data sheet
- Z ... R** = special features by arrangement
- 5** = nominal size 5
- (blank) = NBR (Nitrile) seals (standard)
- V** = FKM (Viton) seals
(special seals - please contact BUCHER)
- 1 ... 9** = design stage (omit when ordering new units)
- ...** = voltage e.g. 24 (24 V)
- D** = **current DC**
- A** = current AC
- (blank) = with connector plug DIN 43 650 / ISO 4400 (standard)
- M100** = shipped without DIN plug
- C** = Kostal plug connection (IP 65)
- JT** = Junior Timer radial plug connection diode, IP65
- IIT** = Junior Timer axial plug connection (With protection diode, IP65)
- D** = Deutsch plug connection DT04-2P (IP 67/69K)
- DT** = Deutsch plug connection DT04-2P (with protection diode, IP67/69K)
- S** = AMP Superseal 1.5 (IP65) plug connection
- F** = with 500 mm flying leads

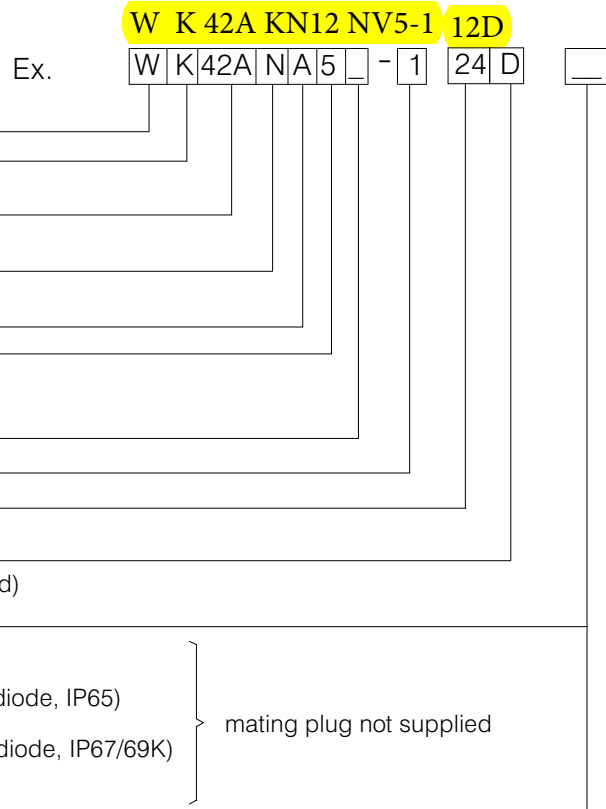

9. Related data sheets

Old no.	New no.	
W-2.140	400-P-120100-EN	Solenoid directional cartridge valves, 5 mm (overview)
W-2.141	400-P-120110-EN	Optional coils for solenoid operated directional valves
G-4.30	400-P-720121-EN	Line mounting body, type GANA (G 3/8")
I-32	400-P-140011-EN	The Form tools hire programme
i-33.12	400-P-040191-EN	BUCHER cavity type AN

info.ch@bucherhydraulics.com

www.bucherhydraulics.com

© 2017 by Bucher Hydraulics AG Frutigen, CH-3714 Frutigen

All rights reserved.

Data is provided for the purpose of product description only, and must not be construed as warranted characteristics in the legal sense. The information does not relieve users from the duty of conducting their own evaluations and tests. Because the products are subject to continual improvement, we reserve the right to amend the product specifications contained in this catalogue.

Classification: 450300.305.310.300