

HOW TO ORDER - SINGLE UNITS

PHP20.11,2 D 0 54 B2 L EA/EA N EL - - - FS
 1 2 3 4 5 6 7 8 9 10 11 12 13

--PHP 20•19--L--0--82--E2--L--EB/EA--N--EL--D--*--GB--FS--

1	Type	Pump type	Motor type
	8,26 cm ³ /rev (0.50 in ³ /rev)	PHP 20•8	PHM 20•8
	10,9 cm ³ /rev (0.66 in ³ /rev)	PHP 20•10,5	PHM 20•10,5
	11,23 cm ³ /rev (0.68 in ³ /rev)	PHP 20•11,2	PHM 20•11,2
	14,53 cm ³ /rev (0.88 in ³ /rev)	PHP 20•14	PHM 20•14
	16,85 cm ³ /rev (1.02 in ³ /rev)	PHP 20•16	PHM 20•16
	18,29 cm ³ /rev (1.11 in ³ /rev)	PHP 20•18	PHM 20•18
	19,09 cm ³ /rev (1.16 in ³ /rev)	PHP 20•19	PHM 20•19
	21,14 cm ³ /rev (1.29 in ³ /rev)	PHP 20•20	PHM 20•20
	23,32 cm ³ /rev (1.42 in ³ /rev)	PHP 20•23	PHM 20•23
	24,84 cm ³ /rev (1.52 in ³ /rev)	PHP 20•24,5	PHM 20•24,5
	26,42 cm ³ /rev (1.61 in ³ /rev)	PHP 20•25	PHM 20•25
	28,21 cm ³ /rev (1.72 in ³ /rev)	PHP 20•27,8	PHM 20•27,8
	33,03 cm ³ /rev (2.01 in ³ /rev)	PHP 20•31,5	PHM 20•31,5

2	Rotation	Code
	Left	S
	Right	D
	Reversible rear external drain	R
	Reversible side external drain	L
	Reversible internl drain	B

3	Outboard bearing options	Code
	Without outboard bearing	0
	Version	W8
	Version	4
	Version	5
	Version	6
	Version	7
	Version	8
	Version	9

4	Drive shaft	Code
	European tapered 1:8	82
	German tapered 1:5	54
	German tapered 1:5	55
	Straight	46
	SAE "A" spline (9 teeth)	03
	SAE spline (10 teeth)	01
	SAE "A" spline (11 teeth)	07
	SAE "A" straight	31
	Straight	49
	Straight	50

Code	Drive shaft	4
04	SAE "B" spline	
32	SAE "B" straight	
12	DIN 54 82 spline	
48	Straight (only for version 6)	
B1	Straight (only for version 8)	
95	Tang	

Code	Mounting flange	5
E2	European	
B2	German	
B4	German 2 bolt	
B5	German 2 bolt	
B6	German 4 bolt	
S9	SAE "A" 2 bolt	
S5	SAE "B" 2 bolt	
W8	German	

Code	Ports position	6
L	IN/OUT side	
H	IN side / OUT rear	0
K	IN rear / OUT side	0
P	Rear	

Code	Ports IN/OUT	7
GERMAN FLANGED PORTS		
Side	Rear	Type 0
BE/BC	PHP 20	8-10,5-11,2,14-16-18-19-20-23-24,5
BC/BE	PHM 20	25-27,8-31,5
EUROPEAN FLANGED PORTS		
Side	Rear	Type 0
EA/EA	PHP 20	8-10,5-11,2
EA/EA	PHM 20	
EB/EA	PHP 20	14-16-18-19-20
EA/EB	PHM 20	23-24,5-25-27,8-31,5
SAE FLANGED PORTS (SSM)		
Side	Rear	Type 0
MA/MA	PHP 20	8-10,5-11,2
MA/MA	PHM 20	
MB/MA	PHP 20	14-16-18-19-20
MA/MB	PHM 20	
MC/MB	PHP 20	23-24,5-25-27,8-31,5
MB/MC	PHM 20	

Replaces: 01/06.2009

04/01.2019

OUTBOARD BEARING OPTIONS

For each version, the possible combination between drive shafts and mounting flanges are shown on pages 34 ÷ 37.
For the outboard bearing life expectancy, diagrams providing approximate selection data will be found on subsequent pages.
For particular applications please consult our pre-sales department.

VERSION 0

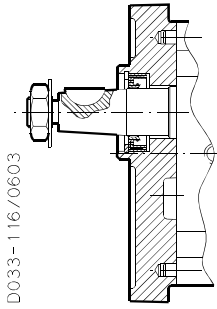

Version for applications without radial and axial load on the drive shaft.

VERSION W8

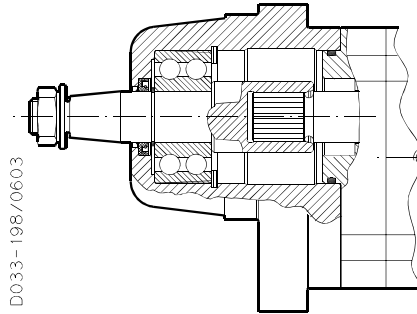

VERSION 4

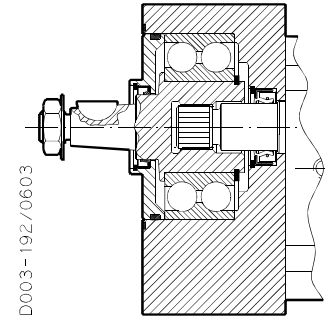

VERSION 5

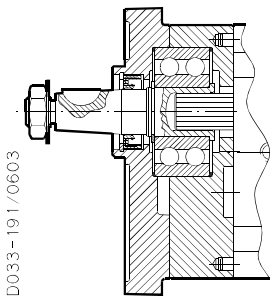

VERSION 6

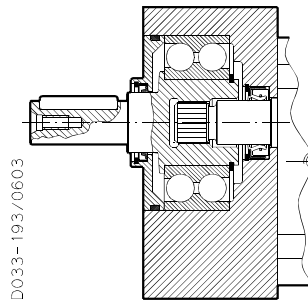

VERSION 7

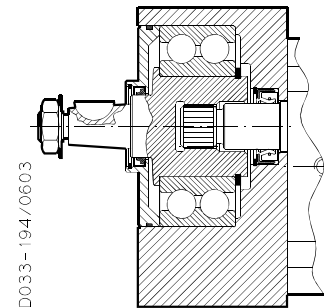

VERSION 8

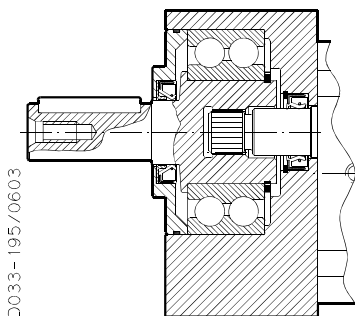

VERSION 9

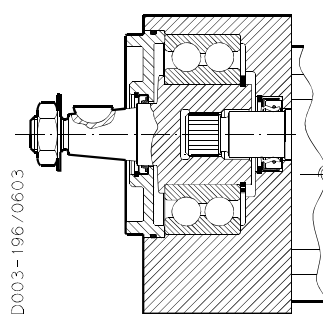

DRIVE SHAFTS

EUROPEAN TAPERED 1:8

82

Not available with size:

20•24,5

Mounting face refer to flange code E2

Replaces: 02/06.2010

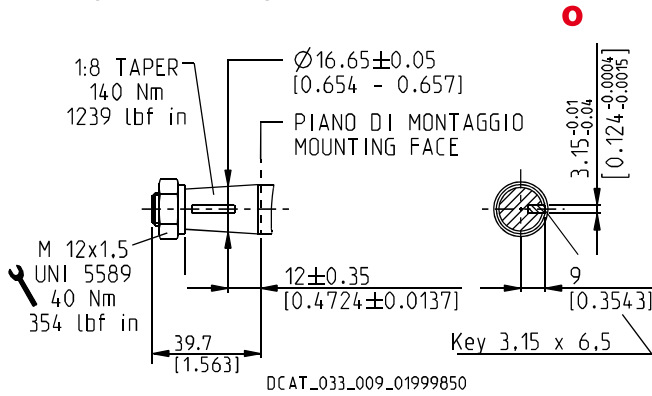

GERMAN TAPERED 1:5

54

Not available with size:

20•24,5

Mounting face refer to flange code B2

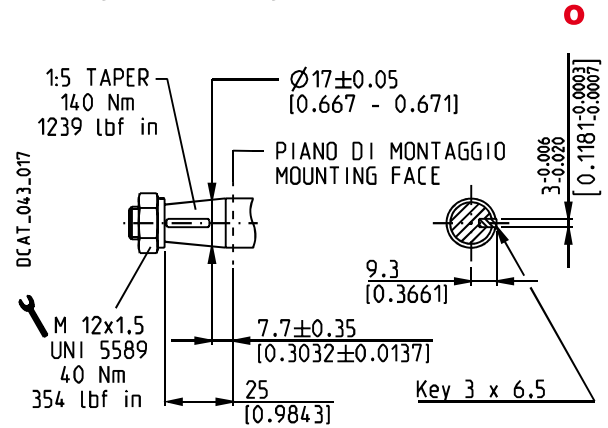

GERMAN TAPERED 1:5

55

Only for version 5, 9 and W8 with outboard bearing

Mounting face refer to flange code B2

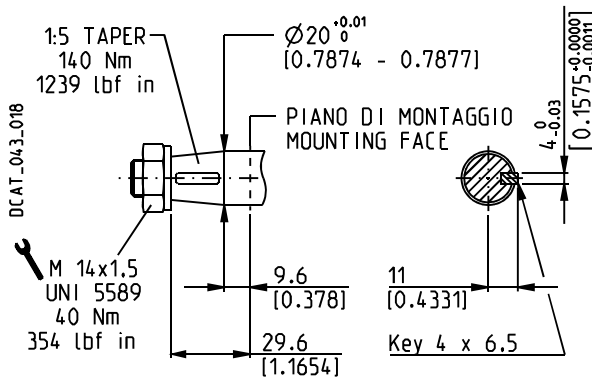

STRAIGHT

46

Not available with size:

20•10,5 - 20•18 - 20•19 - 20•23 - 20•24,5 - 20•27,8

Mounting face refer to flange code E2

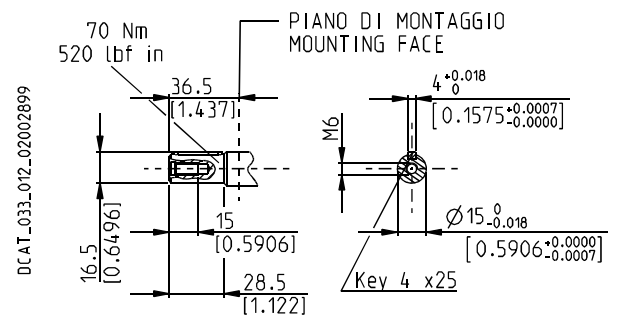

SAE "A" SPLINE

03

Mounting face refer to flange code S9

04/01.2019

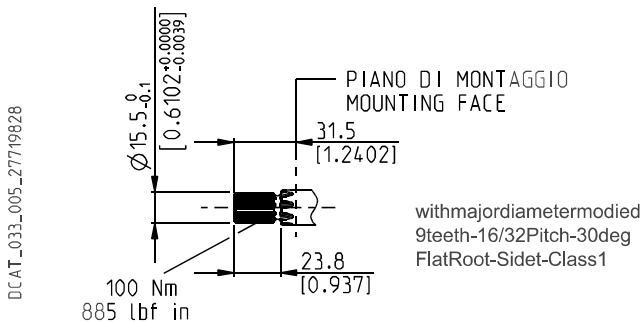

SPLINE

01

Mounting face refer to flange code S9

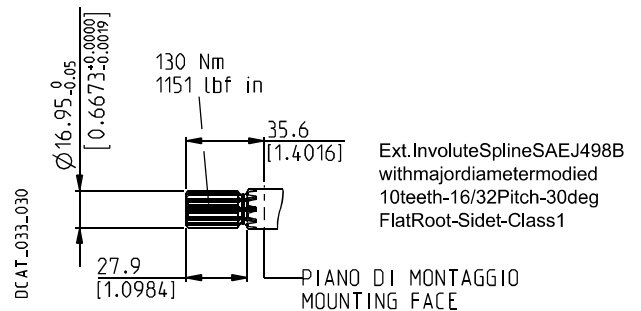

MOUNTING FLANGES AND TABLE OF COMPATIBILITY

EUROPEAN

E2

Material: cast iron and aluminium

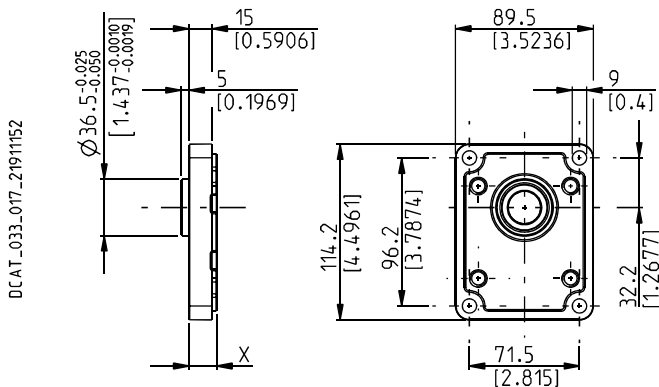

DRIVE SHAFTS

See page 31 ÷ 33

VERSIONS See page 26	X mm (in)	82	46	B1	03	04	07	12	31	48	49	50	54
0	18 (0.71)	#	#		X	X	X	X	X	X	X	X	X
4	55,4 (2.18)	#											
5	43,6 (1.72)	#		X	X						X	X	X
6	55,4 (2.18)									#			
7	59,4 (2.34)	#											
8	59,4 (2.34)			#									

Standard combination

X Available combination

GERMAN

B2

Material: cast iron and aluminium

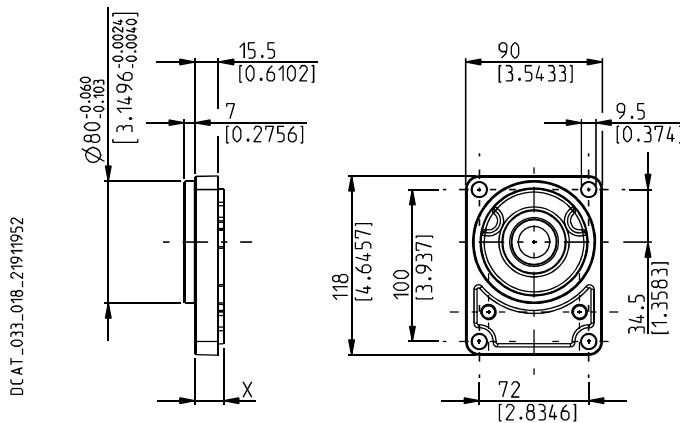

DRIVE SHAFTS

See page 31 ÷ 33

VERSIONS See page 26	X mm (in)	12	54	55	01	03	31	46	49	82
0	18,8 (0.74)	#	#		X	X	X	X	X	X
5	44,4 (1.75)		X	X		X			X	X
9	59,4 (2.34)			X						

Standard combination

X Available combination

01/06.2009

PORTS POSITION AND TYPE

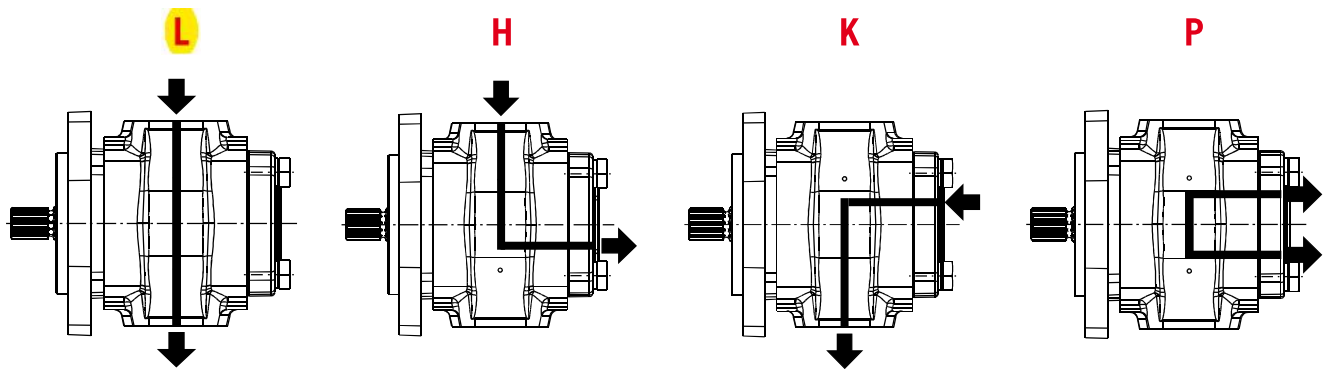

Replaces: 01/06.2009

PORTS TYPE	SIDE PORTS												REAR PORTS			
	European		Split SSM		Split SSS		Gas BSPP		SAE ODT		German		Gas BSPP		SAE ODT	
Pump type	IN	OUT	IN	OUT	IN	OUT	IN	OUT	IN	OUT	IN	OUT	IN	OUT	IN	OUT
Motor type	OUT	IN	OUT	IN	OUT	IN	OUT	IN	OUT	IN	OUT	IN	OUT	IN	OUT	IN
PHP 20•8 ○	EA	EA	MA	MA	SA	SA	GD	GD	OC	OC	BE	BC	GD	GD	OC	OC
PHP 20•10,5 ○	EA	EA	MA	MA	SA	SA	GD	GD	OC	OC	BE	BC	GD	GD	OC	OC
PHP 20•11,2 ○	EA	EA	MA	MA	SA	SA	GD	GD	OC	OC	BE	BC	GD	GD	OC	OC
PHP 20•14 ○	EB	EA	MB	MA	SB	SA	GE	GD	OD	OC	BE	BC	GE	GD	OD	OC
PHP 20•16 ○	EB	EA	MB	MA	SB	SA	GE	GD	OD	OC	BE	BC	GE	GD	OD	OC
PHP 20•18 ○	EB	EA	MB	MA	SB	SA	GE	GD	OD	OC	BE	BC	GE	GD	OD	OC
PHP 20•19	EB	EA	MB	MA	SB	SA	GE	GD	OD	OC	BE	BC	GE	GD	OD	OC
PHP 20•20	EB	EA	MB	MA	SB	SA	GE	GD	OD	OC	BE	BC	GE	GD	OD	OC
PHP 20•23	EB	EA	MC	MB	SC	SB	GF	GD	OF	OC	BE	BC	GE	GD	OD	OC
PHP 20•24,5	EB	EA	MC	MB	SC	SB	GF	GD	OF	OC	BE	BC	GE	GD	OD	OC
PHP 20•25	EB	EA	MC	MB	SC	SB	GF	GD	OF	OC	BE	BC	GE	GD	OD	OC
PHP 20•27,8	EB	EA	MC	MB	SC	SB	GF	GD	OF	OC	BE	BC	GE	GD	OD	OC
PHP 20•31,5	EB	EA	MC	MB	SC	SB	GF	GD	OF	OC	BE	BC	GE	GD	OD	OC

Different inlet and outlet ports are available.
For more information please consult our pre-sales department.

EXTERNAL DRAIN PORTS

IN/OUT PORTS TYPE	SIDE PORTS						REAR PORTS	
	German	European	Split SSM	Split SSS	Gas BSPP	SAE ODT	Gas BSPP	SAE ODT
PHP 20	TA	GB	GB	03	GB	03	GB	03

Dimensions on page 42

○ 04/01.2019

PORT SIZES

 Tightening torque for low pressure side port.



 Tightening torque for high pressure side port.

For reversible rotation, please consult only the tightening torque for high pressure side port.

EUROPEAN FLANGED PORTS - 4 Bolts

EUROPEAN

Metric thread ISO 60° conforms to ISO/R 262

CODE	A	B	C		
	mm (in)	mm (in)	Thread Depth mm (in)	Nm (lbf in)	Nm (lbf in)
EA	13 (0.51)	30 (1.18)	M 6 13 (0.51)	8 ^{0,5} (71 ÷ 75)	8 ^{0,5} (71 ÷ 75)
EB	19 (0.75)	40 (1.57)	M 8, 14 (0.55)	15 ⁺¹ (133 ÷ 142)	20 ⁺¹ (177 ÷ 186)

DCAT_006_024_21060533

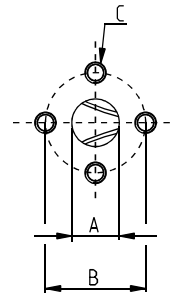



SAE FLANGED PORTS J518 - Standard pressure series 3000 PSI

SSM

Metric thread ISO 60° conforms to ISO/R 262

01/06.2009

CODE	A	B	C	D		
	mm (in)	mm (in)	mm (in)	Thread Depth mm (in)	Nm (lbf in)	Nm (lbf in)
MA	12,5 (0.49)	38,1 (1.50)	17,5 (0.69)	M 8 14 (0.55)	15 ⁺¹ (133 ÷ 142)	15 ⁺¹ (133 ÷ 142)
MB	19 (0.75)	47,6 (1.87)	22,2 (0.87)	M 10 14 (0.55)	20 ⁺¹ (177 ÷ 186)	25 ⁺¹ (266 ÷ 288)
MC	25,4 (1.00)	52,4 (2.06)	26,2 (1.03)	M 10 14 (0.55)	20 ⁺¹ (177 ÷ 186)	25 ⁺¹ (266 ÷ 288)

DCAT_006_025_21064252

