



# Mobile Hydraulic Pumps T6CCZ

Denison Vane Technology, fixed displacement

aerospace  
climate control  
electromechanical  
filtration  
fluid & gas handling  
**hydraulics**  
pneumatics  
process control  
sealing & shielding



ENGINEERING YOUR SUCCESS.

**Ordering Code**

Model N°.

Series - SAE B 2 bolts  
Mounting flange J 744 c

One letter can be added to specify special parts in series

Cam ring for "P1" and "P2"  
(Delivery at 0 bar & 1500 r.p.m.)

- B03 = 16,2 l/min
- B05 = 25,8 l/min
- B06 = 31,9 l/min
- B08 = 39,6 l/min
- B10 = 51,1 l/min
- B12 = 55,6 l/min**
- B14 = 69,0 l/min
- B17 = 87,4 l/min
- B20 = 95,7 l/min
- B22 = 105,4 l/min
- B25 = 118,9 l/min**
- B28 = 133,2 l/min
- B31 = 150,0 l/min

Type of shaft

- X = keyed
- V = keyed**
- W = keyed

T6CCZ - B25 - B12 - V R 00 - A 1 1M

T6CCZ - B22 - B10 - X R 00 - A - 1 00 -

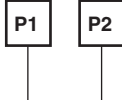

Modifications

Mounting W/ connection variables

	P1 = 1"		S = 2"	
	UNC		Metric	
P2	1"	3/4"	1"	3/4"
Code	00	01	0M	W0
	P1 = 1"		S = 2.1/2"	
	UNC		Metric	
P2	1"	3/4"	1"	3/4"
Code	10	11	1M	W1

Seal class

**1 = S1 - BUNA N (for mineral oil)**

Design letter

Porting combination (see page 3)

Direction of rotation (view on shaft end)

**R = clockwise**

L = counter-clockwise

**INTERNAL LEAKAGE (TYPICAL)**

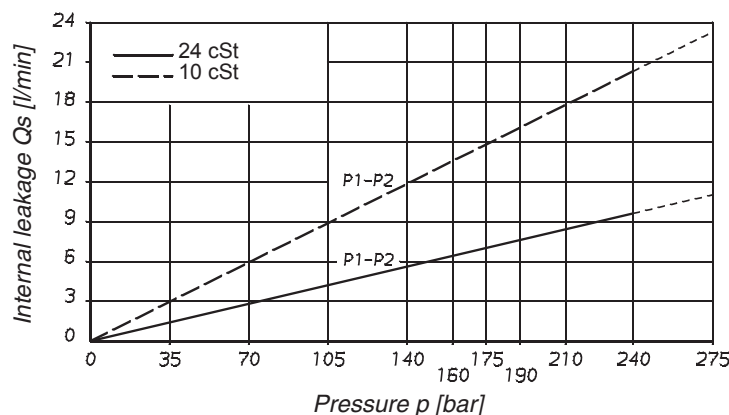

**POWER LOSS HYDROMECHANICAL (TYPICAL)**

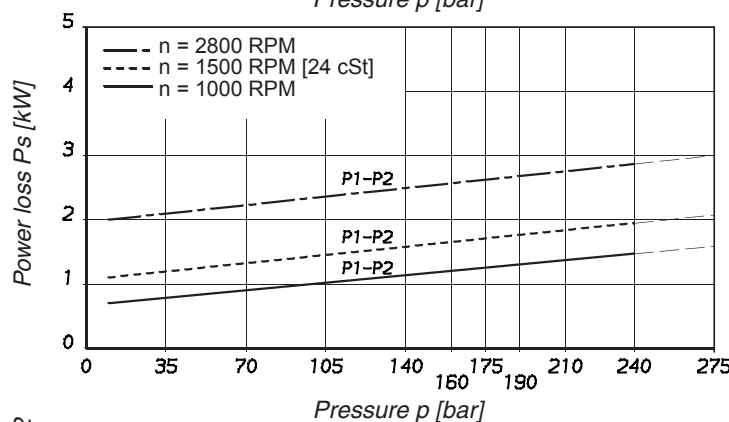

**NOISE LEVEL (TYPICAL)**

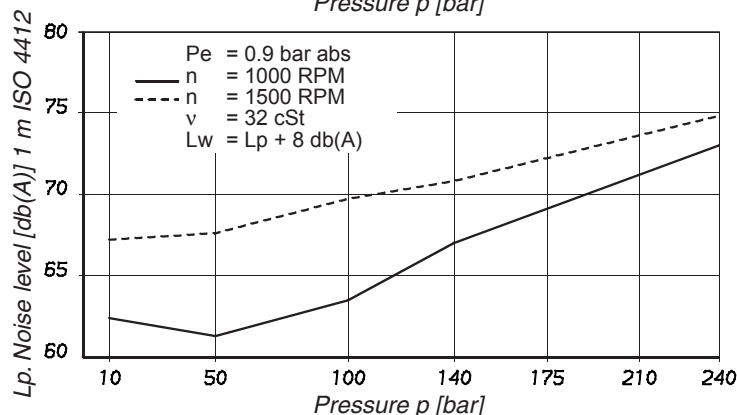

**PORTING COMBINATION**

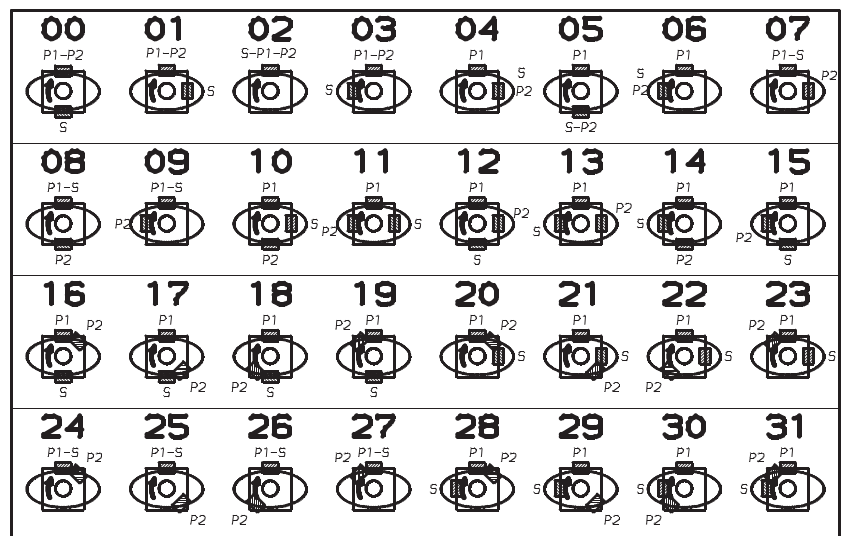

**GENERAL DESCRIPTION**

The T6CCZ pump incorporates Parker high quality and performances of T6CC series vane pumps mobile application. High maximum permissible shaft loads is particularly well adapted to applications of pump driven by cardan. A double raw ball bearing and a needle bearing double the permissible radial load compare to standard T6CC bearing capability. (see page 4).

**GREATER FLOW**

3 to 31 GPM, 10 to 100 ml/rev.

**HIGHER PRESSURE**

275 bar maximum except B28 and B31 cartridge 210 bar.

**WIDER SPEED RANGE**

400 up to 2800 RPM with petroleum based antiwear R & O fluids which are the recommended fluids.(except B25, B28, B31 - 2500 RPM max. speed)

**BETTER EFFICIENCY**

Better than 94 % for energy saving.

**MOUNTING FLEXIBILITY**

Up to 32 positions.

**WIDER RANGE OF ACCEPTABLE VISCOSITY**

2000 cSt max. viscosity (cold start low speed and pressure).  
 30 cSt optimum (max. life).  
 10 cSt minimum (full speed and pressure)

**PERMISSIBLE RADIAL LOAD  
SHAFT CODE X**

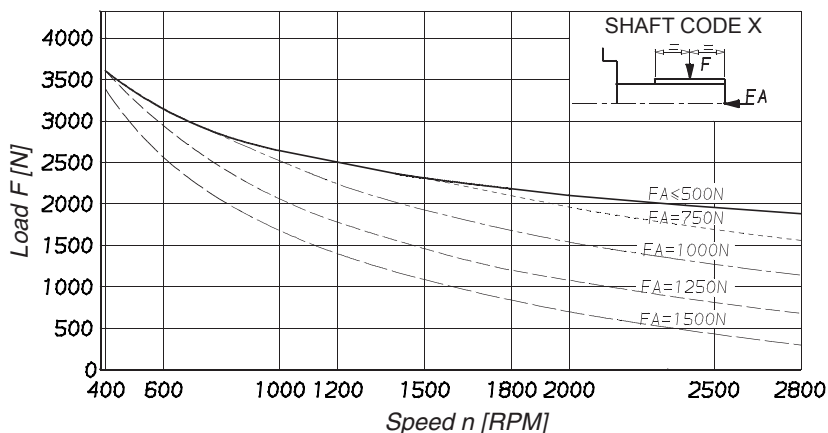

**PERMISSIBLE RADIAL LOAD  
SHAFT CODE V**

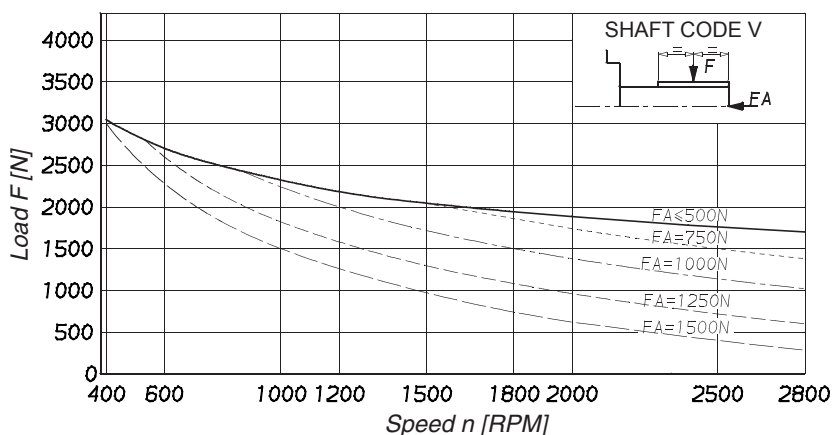

**PERMISSIBLE RADIAL LOAD  
SHAFT CODE W**

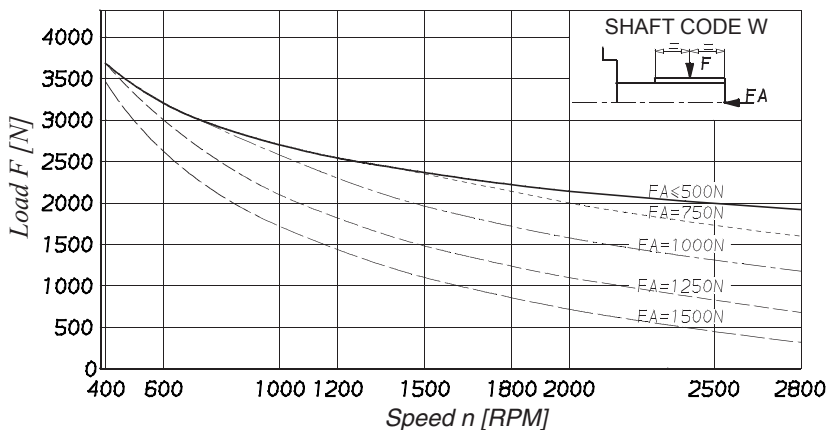

These curves permit to simultaneously check the maximum permissible radial and axial load on the shaft involved. Those load value are determined for 10 000 hours bearing lifetime at operating under  $F_a$  and  $F$  given to get information for a different lifetime the radial load corrected is.

If  $F_a$  is smaller than minimum axial force on the curves then

$$\text{Correct } F = \frac{F \text{ curve}}{3,33 \sqrt{\frac{LH \text{ Required}}{10000}}} \quad LH = \text{Lifetime in hours}$$

If  $F_a$  is higher than minimum axial force then  $F$  radial load is :

$$\text{Correct } F = \frac{F \text{ curve}}{3 \sqrt{\frac{LH \text{ Required}}{10000}}}$$

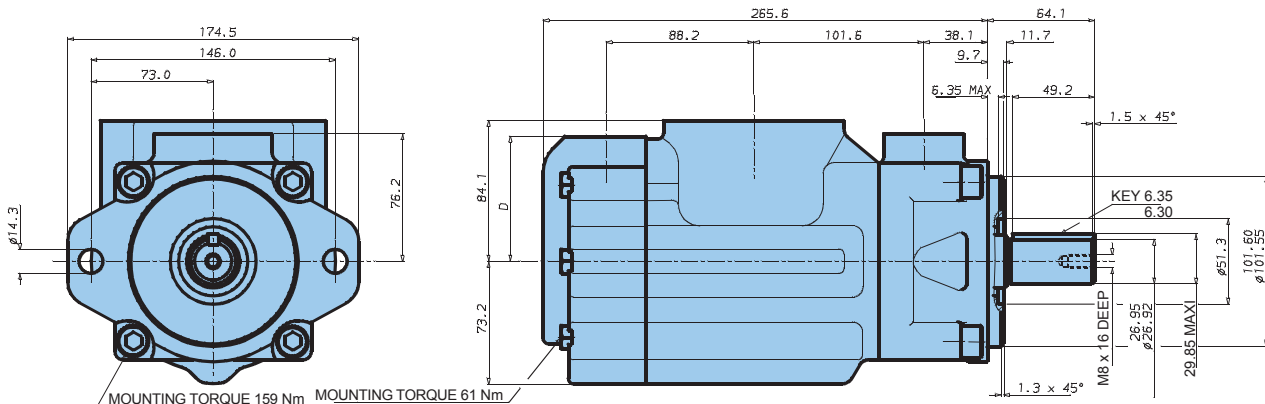

Shaft Code X

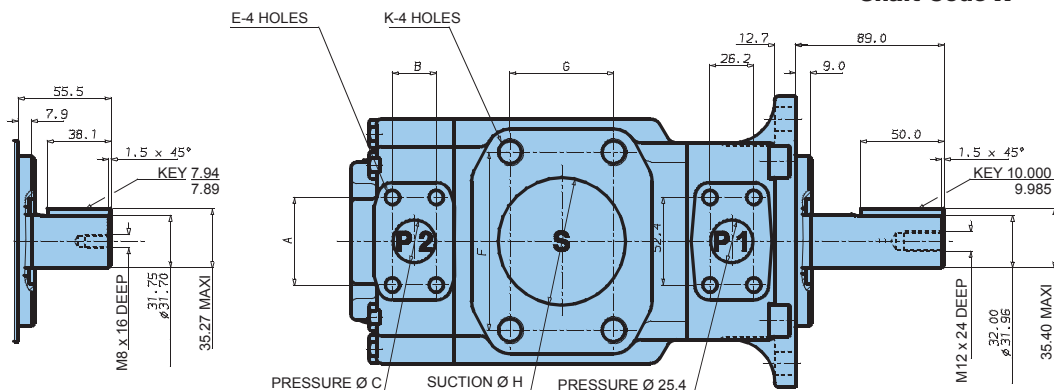

Shaft Code W

Shaft Code V

Shaft torque limits [ml/rev. x bar]	
Shaft	Vi x p max P1 + P2
X	25400
<b>V</b>	<b>32670</b>
W	32670

	Alternate Port							
	S = 3"				S = 2" 1/2 <sup>2)</sup>			
F	106,4				88,9			
G	61,9				50,8			
Ø H	76,2				63,5			
Code	00	01 <sup>1)</sup>	0M	M0 <sup>1)</sup>	10	11 <sup>1)</sup>	1M	M1 <sup>1)</sup>
A	52,4	47,7	52,4	47,7	52,4	47,7	52,4	47,7
B	26,2	22,4	26,2	22,4	26,2	22,4	26,2	22,4
Ø C	25,4	19,0	25,4	19,0	25,4	19,0	25,4	19,0
D	74,7	76,2	74,7	76,2	74,7	76,2	74,7	76,2
E	3/8"-16 UNC x 19,0 deep		M10 x 19,0 deep		3/8"-16 UNC x 19,0 deep		M10 x 19,0 deep	
K	5/8"-11UNC x 28,4 deep		M16 x 28,4 deep		1/2"-13 UNC x 23,9 deep		M12 x 23,9 deep	

<sup>1)</sup> max. cam 014

<sup>2)</sup> P1 + P2 = 126 cm<sup>3</sup> / rev max.

**OPERATING CHARACTERISTICS - TYPICAL (24 cSt)**

Pressure port	Series	Volumetric displ. Vi ml/rev.	Flow Q [l/min] n = 1500 RPM			Input power P [kW] n = 1500 RPM		
			p = 0 bar	p = 140 bar	p = 240 bar	p = 7 bar	p = 140 bar	p = 240 bar
P1 & P2	B03	10,8	16,2	10,7	-	1,3	5,3	-
	B05	17,2	25,8	20,3	15,8	1,4	7,5	12,2
	B06	21,3	31,9	26,4	21,9	1,5	8,9	14,7
	B08	26,4	39,6	34,1	29,6	1,6	10,7	17,7
	B10	34,1	51,1	45,6	41,1	1,7	13,4	22,3
	<b>B12</b>	<b>37,1</b>	<b>55,6</b>	<b>50,1</b>	<b>45,6</b>	<b>1,7</b>	<b>14,4</b>	<b>24,1</b>
	B14	46,0	69,0	63,5	59,0	1,9	17,6	29,5
	B17	58,3	87,4	81,9	77,4	2,1	21,9	36,9
	B20	63,8	95,7	90,7	85,7	2,2	23,8	40,2
	B22	70,3	105,4	99,9	95,4	2,3	26,1	44,1
<b>B25*</b>	<b>79,3</b>	<b>118,9</b>	<b>113,4</b>	<b>108,9</b>	<b>2,5</b>	<b>29,2</b>	<b>49,5</b>	
B28*	88,8	133,2	127,7	124,5**	2,8	32,7	48,5**	
B31*	100,0	150,0	144,5	141,3**	2,8	36,5	54,4**	

\* B25 - B28 - B31 = 2500 R.P.M. max.

\*\* B28 - B31 = 210 bar max. int.

- Not to use because internal greater than 50 % theoretical flow.

# Parker Worldwide

**AE – UAE, Dubai**  
Tel: +971 4 8127100  
parker.me@parker.com

**AR – Argentina, Buenos Aires**  
Tel: +54 3327 44 4129

**AT – Austria, Wiener Neustadt**  
Tel: +43 (0)2622 23501-0  
parker.austria@parker.com

**AT – Eastern Europe, Wiener Neustadt**  
Tel: +43 (0)2622 23501 900  
parker.easteurope@parker.com

**AU – Australia, Castle Hill**  
Tel: +61 (0)2-9634 7777

**AZ – Azerbaijan, Baku**  
Tel: +994 50 2233 458  
parker.azerbaijan@parker.com

**BE/LU – Belgium, Nivelles**  
Tel: +32 (0)67 280 900  
parker.belgium@parker.com

**BR – Brazil, Cachoeirinha RS**  
Tel: +55 51 3470 9144

**BY – Belarus, Minsk**  
Tel: +375 17 209 9399  
parker.belarus@parker.com

**CA – Canada, Milton, Ontario**  
Tel: +1 905 693 3000

**CH – Switzerland, Etoy**  
Tel: +41 (0) 21 821 02 30  
parker.switzerland@parker.com

**CL – Chile, Santiago**  
Tel: +56 2 623 1216

**CN – China, Shanghai**  
Tel: +86 21 2899 5000

**CZ – Czech Republic, Klecany**  
Tel: +420 284 083 111  
parker.czechrepublic@parker.com

**DE – Germany, Kaarst**  
Tel: +49 (0)2131 4016 0  
parker.germany@parker.com

**DK – Denmark, Ballerup**  
Tel: +45 43 56 04 00  
parker.denmark@parker.com

**ES – Spain, Madrid**  
Tel: +34 902 330 001  
parker.spain@parker.com

**FI – Finland, Vantaa**  
Tel: +358 (0)20 753 2500  
parker.finland@parker.com

**FR – France, Contamine s/Arve**  
Tel: +33 (0)4 50 25 80 25  
parker.france@parker.com

**GR – Greece, Athens**  
Tel: +30 210 933 6450  
parker.greece@parker.com

**HK – Hong Kong**  
Tel: +852 2428 8008

**HU – Hungary, Budapest**  
Tel: +36 1 220 4155  
parker.hungary@parker.com

**IE – Ireland, Dublin**  
Tel: +353 (0)1 466 6370  
parker.ireland@parker.com

**IN – India, Mumbai**  
Tel: +91 22 6513 7081-85

**IT – Italy, Corsico (MI)**  
Tel: +39 02 45 19 21  
parker.italy@parker.com

**JP – Japan, Fujisawa**  
Tel: +(81) 4 6635 3050

**KR – South Korea, Seoul**  
Tel: +82 2 559 0400

**KZ – Kazakhstan, Almaty**  
Tel: +7 7272 505 800  
parker.easteurope@parker.com

**LV – Latvia, Riga**  
Tel: +371 6 745 2601  
parker.latvia@parker.com

**MX – Mexico, Apodaca**  
Tel: +52 81 8156 6000

**MY – Malaysia, Shah Alam**  
Tel: +60 3 7849 0800

**NL – The Netherlands, Oldenzaal**  
Tel: +31 (0)541 585 000  
parker.nl@parker.com

**NO – Norway, Ski**  
Tel: +47 64 91 10 00  
parker.norway@parker.com

**NZ – New Zealand, Mt Wellington**  
Tel: +64 9 574 1744

**PL – Poland, Warsaw**  
Tel: +48 (0)22 573 24 00  
parker.poland@parker.com

**PT – Portugal, Leca da Palmeira**  
Tel: +351 22 999 7360  
parker.portugal@parker.com

**RO – Romania, Bucharest**  
Tel: +40 21 252 1382  
parker.romania@parker.com

**RU – Russia, Moscow**  
Tel: +7 495 645-2156  
parker.russia@parker.com

**SE – Sweden, Spånga**  
Tel: +46 (0)8 59 79 50 00  
parker.sweden@parker.com

**SG – Singapore**  
Tel: +65 6887 6300

**SK – Slovakia, Banská Bystrica**  
Tel: +421 484 162 252  
parker.slovakia@parker.com

**SL – Slovenia, Novo Mesto**  
Tel: +386 7 337 6650  
parker.slovenia@parker.com

**TH – Thailand, Bangkok**  
Tel: +662 717 8140

**TR – Turkey, Istanbul**  
Tel: +90 216 4997081  
parker.turkey@parker.com

**TW – Taiwan, Taipei**  
Tel: +886 2 2298 8987

**UA – Ukraine, Kiev**  
Tel: +380 44 494 2731  
parker.ukraine@parker.com

**UK – United Kingdom, Warwick**  
Tel: +44 (0)1926 317 878  
parker.uk@parker.com

**US – USA, Cleveland (industrial)**  
Tel: +1 216 896 3000

**US – USA, Lincolnshire (mobile)**  
Tel: +1 847 821 1500

**VE – Venezuela, Caracas**  
Tel: +58 212 238 5422

**ZA – South Africa, Kempton Park**  
Tel: +27 (0)11 961 0700  
parker.southafrica@parker.com

**European Product Information Centre**  
Free phone: 00 800 27 27 5374  
(from AT, BE, CH, CZ, DE, DK, EE, ES, FI, FR, IE, IL, IS, IT, LU, MT, NL, NO, PL, PT, RU, SE, UK, ZA)



**Parker Hannifin Ltd.**  
Tachbrook Park Drive  
Tachbrook Park, Warwick CV34 6TU  
United Kingdom  
Tel.: +44 (0) 1926 317 878  
Fax: +44 (0) 1926 317 855  
www.parker.com