

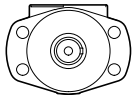

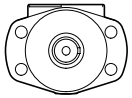
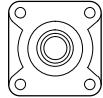

Pos. 1				
Gehäuse komplett Housing assembly Carter Scatola motore				
	ME012015J4 CODE EW	ME012041J4 CODE MW	ME012032J4 CODE HW	-----
	ME012037J4 CODE EN	ME012039J4 CODE MN	ME012030J4 CODE HK	-----
	ME012034J4 CODE EV	ME012038J4 CODE MV	ME012042J4 CODE HV	-----
Endanschluss Rear port Orifices arrière Alim. laterale	ME012036J4 CODE E*	ME012004J4 CODE M*	ME012055J4 CODE H*	ME012049J4 CODE V*

Pos. 2			Pos. 14	
Abtriebswelle / Coupling shaft Arbre / Albero uscita			Passfeder / Key Clavette / Chiavetta	Scheibenfeder Woodruff key Clavette / Chiavetta
	Ø 31.75	ME019012 CODE 45	52530507	-----
	1:8 1.25 inch	ME019000 CODE 08	-----	G124554
	Ø 32.00	ME019024 CODE 46	039044	-----
	12/24 pitch 14 teeth	ME019013 CODE 44	-----	-----

	Pos. 3		Pos. 4	Pos. 5
Baugröße Size Taille Grandezza	Schraube / Bolt Vis / Vite	Für Endanschluss For rear port Pour orifices arrière Per alimentazione laterale	Rotor komplett Rotor set Jeu rotor Rotore	Zwischenwelle Drive link Abre d'entrain Albero entrata
140	021390	021273	ME097003	ME093000
170	021376	021387	ME107003	ME103000
195	021352	021379	ME127003	ME123000
240	021272	021291	ME157003	ME153000
280	021340	021392	ME187003	ME183000
335	021273	021385	ME217003	ME213000
405	021379	021415	ME247003	ME243000
475	021392	021394	ME297003	ME293000
530	021385	021393	ME337003	ME333000
625	021366	021329	ME377003	ME373000
785	021395	021388	ME487003	ME483000
960	021396	021389	ME587003	ME583000

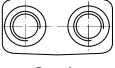
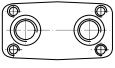
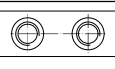
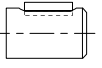
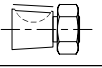
Pos. 6	
Dichtsatz komplett Seal kit Jeu de joints Kit guarnizioni	SK000092

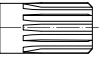
Pos. 8	
Axiallager Thrust bearing Roulement Cuscinetto reggispinta	068024

Pos. 9	
Zwischenscheibe Wear plate Plaque d'usure Piastra d'usura	477342

Pos. 10		
Verteiler Manifold Plan de pose Distributore	ME015000 Standard	CODE 0
Verteiler Manifold Plan de pose Distributore	ME015001 Reverse	CODE 1

Pos. 12	
Kommutator komplett Commutator assembly Ensemble commutateur Assieme distributore	MF018000A1
Für Endanschluss For rear port Pour orifices arrière Per alimentazione laterale	MF018001A1

Pos. 13		
Abschlussplatte / End cover Couvercle / Coperchio posteriore ME016000 Standard		
Für Endanschluss / For rear port Pour orifices arrière Per alimentazione laterale		
ME016009	7/8-14 UNF Axial	CODE A
ME016002	7/8-14 UNF Radial	CODE B
ME016007	Universal	CODE L
ME016010	G 1/2 Radial	CODE X
ME016011	G 1/2 Axial	CODE Y

Pos. 15	
Selbstsichernde Mutter Self-locking nut Ecrou nyl-stop Dado autobloccante	025126
Kronenmutter Castle nut Ecrou crénelé Tuerca	025132

Pos. 16	
Wellenring Circlip Circlips Anello seeger	401333

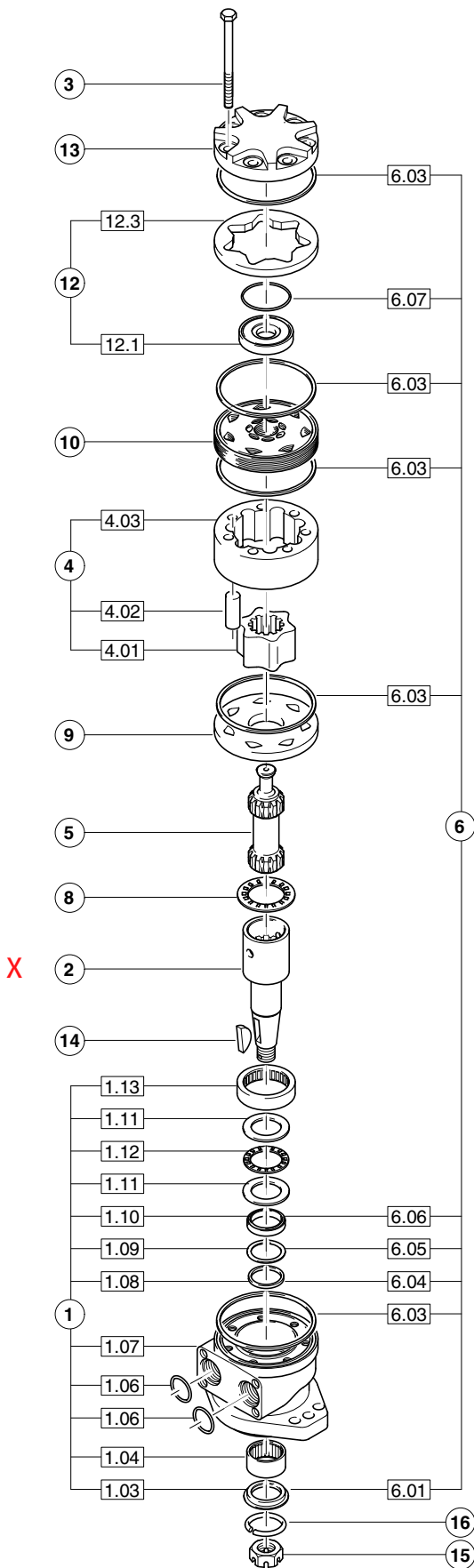

61...75Nm Anziehmoment wechselseitig an 7 Schrauben.

61...75Nm torque max. 7 bolts crosswise.

61...75Nm couple moteur max. 7 boulons réciproquement.

61...75Nm coppia di serraggio 7 bulloni.

Kommutator komplett mit neuer Dichtung einsetzen. Die flache Seite der Dichtung zeigt nach außen.

Fit commutator assembly with new seals. Assemble seal flat side out.

Remonter l'ensemble commutateur avec un nouveau joint côté plat à l'extérieur.

Montare il distributore con la nuova guarnizione con il lato piano verso l'esterno.

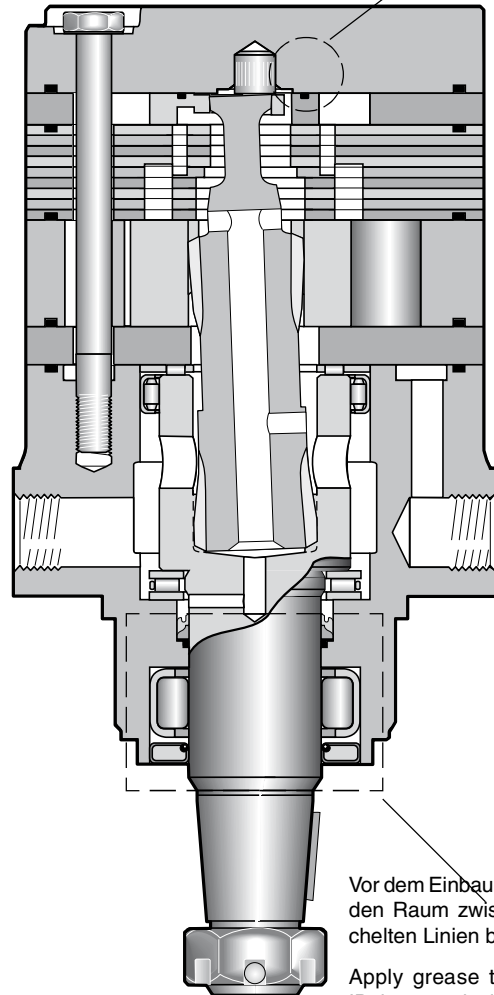
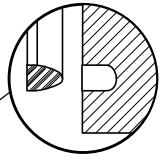

Vor dem Einbau der Abtriebswelle den Raum zwischen den gestrichelten Linien befeuchten.

Apply grease to shaft OD. and ID. in area designated by dotted lines.

Avant l'assemblage de l'arbre veuillez graisser l'espace situé entre les lignes en tirets.

Prima del montaggio dell'albero pregasi lubrificare la zona evidenziata con linee tratteggiate.