



Torqmotor™
Series TF/TG/TH/TK
max. 49 kW

Catalogue HY11-3213/EU
Ed. 06 / 2003



Performance

**Torqmotor
Series TF**

Drehzahl Speed Vitesse de rotation Velocità di rotazione	5...750 rev/min
Schluckstrom Oil flow Débit d'huile Portata	max. 100 l/min
Eingangsdruck Supply pressure Pression entrée Pressione in entrata	max. 300 bar
Drehmoment Torque Couple Coppia	max. 900 Nm
Seitenlast Side load Charges latérales Carico radiale	max. 16.000 N

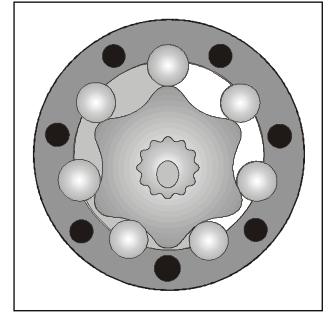
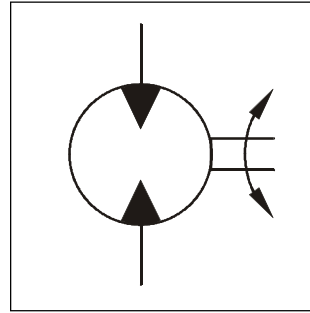

Motor series TF	cm ³ /U cm ³ /rev cm ³ /tr cm ³ /giro	cont / int U/min rev/min tr/min giri/min	cont / int l/min	cont / int bar	max bar	cont / int Nm	cont / int max. KW	cont / int Nm
TF 80	81	550/730	45/60	200/280	300	215/295	19	172/236
TF 100	100	600/750	60/75	160/240	300	210/315	21	168/252
TF 130	128	470/580	60/75	140/200	300	240/350	19	192/280
TF 140	141	370/530	60/75	140/200	300	250/390	18	197/308
TF 170	169	355/440	60/75	140/200	300	330/485	19	264/388
TF 195	197	300/380	60/75	140/200	300	380/560	19	304/448
TF 240	238	320/420	75/100	140/200	300	460/685	24	368/548
TF 280	280	270/350	75/100	140/200	300	550/800	24	440/640
TF 360	364	200/260	75/100	130/200	300	590/910	24	510/780
TF 405	405	170/230	75/100	130/175	300	650/910	21	575/789
TF 475	477	150/200	75/100	115/140	300	680/850	17	603/740

int. =

Intermittierende Werte maximal: 10% von jeder Betriebsminute.

Intermittent operation rating applies to 10% of every minute.

Fonctionnement interm.: 10% max. de chaque minute d'utilisation.

Servizio intermittente: 10% max di ogni minuto di utilizzazione.

Torqmotoren 3213.PM6.5 RH

Code E

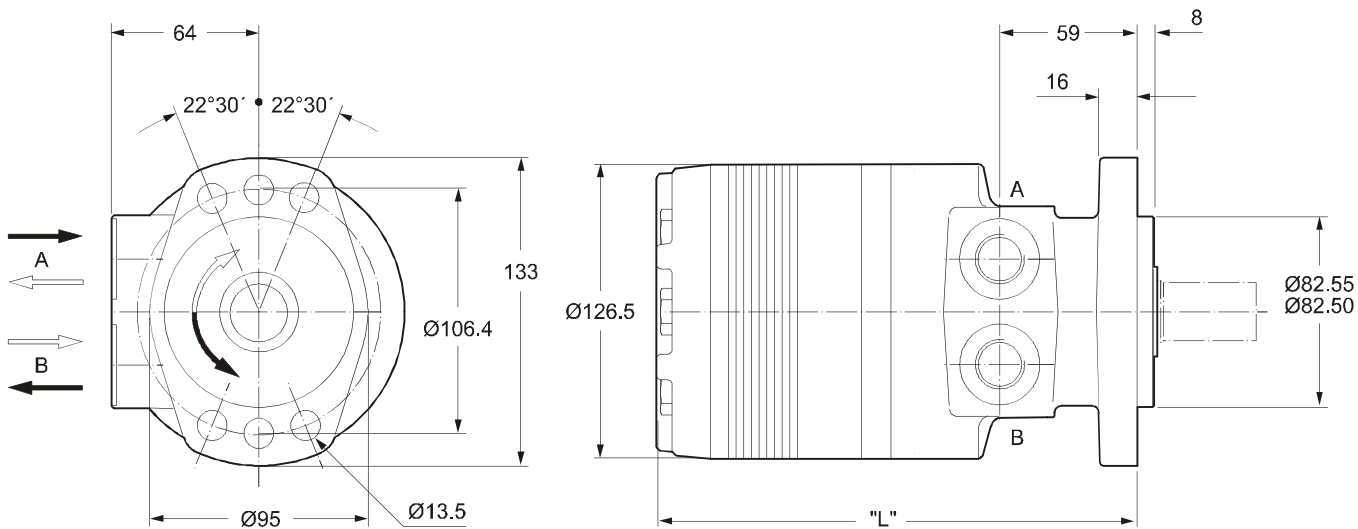

Code M

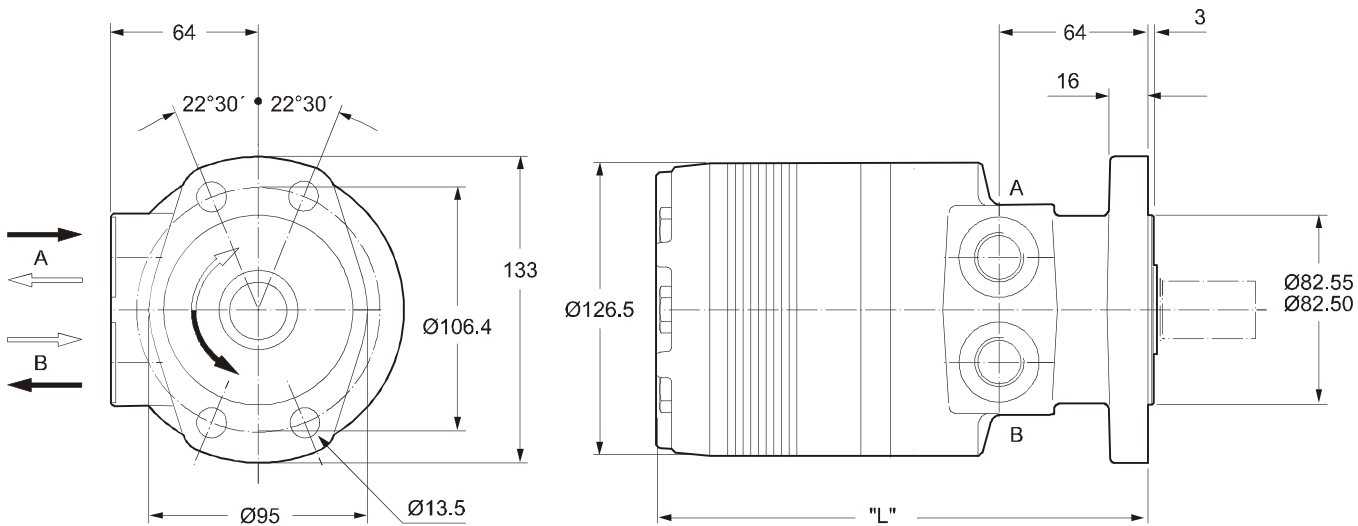

Gewicht / Weight		TF80	TF100	TF130	TF140	TF170	TF195	TF240	TF280	TF360	TF405	TF475
Poids / Peso	kg	13.6	13.7	13.9	14.0	14.2	14.7	15.0	15.5	16.0	16.5	17.5
Code E	"L" mm	186	186	189	191	194	197	202	206	215	220	229
Code M	"L" mm	191	191	194	196	199	202	207	212	220	225	234

Code 44

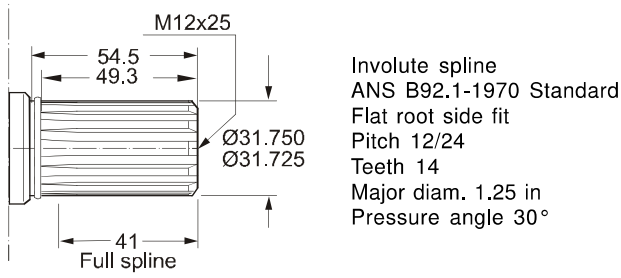

Code 45

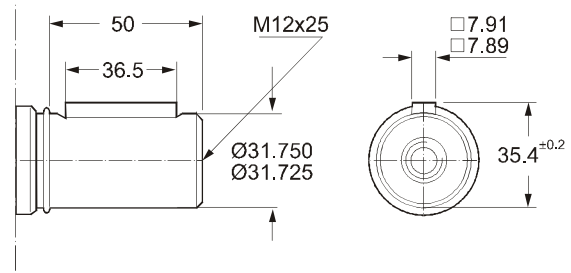

Code 08

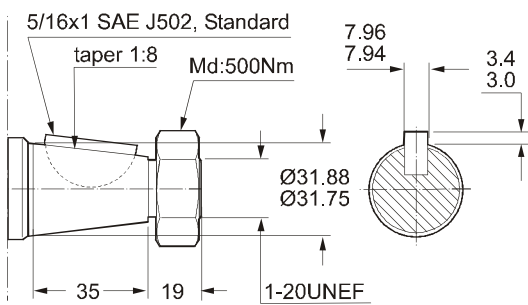

Code 46

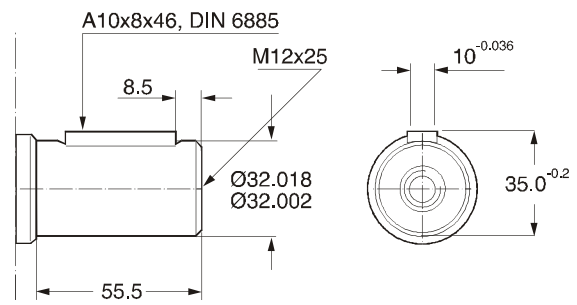

Code 26

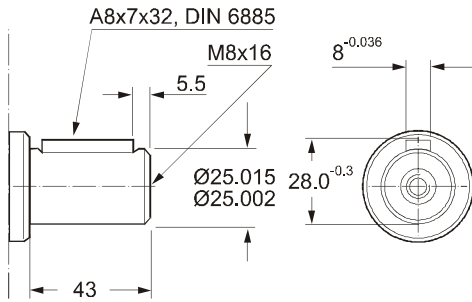

Code 47

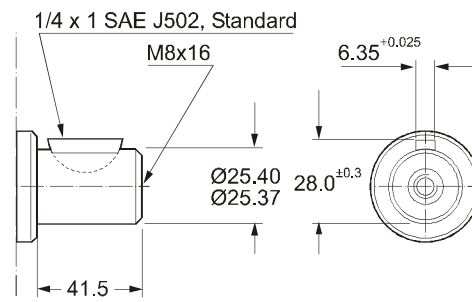

Code 41

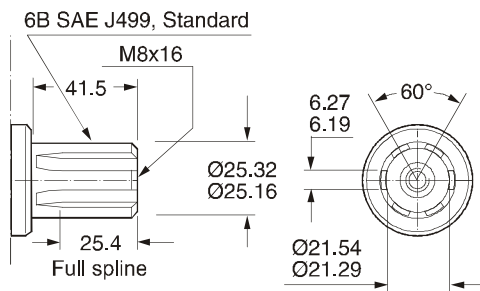

Codes 26, 41, 47

Abtriebswelle Ø 25mm Max. Moment cont./int.
 Coupling shaft Ø 1 inch Max. torque cont./int.
 Arbre 6B SAE Couple maxi cont./int.
 Albero Coppia max cont./int. } 450/550 Nm

TF 240

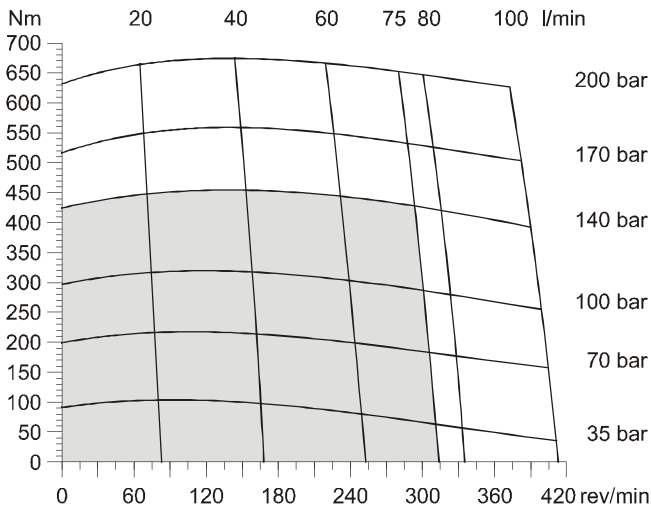

TF 280

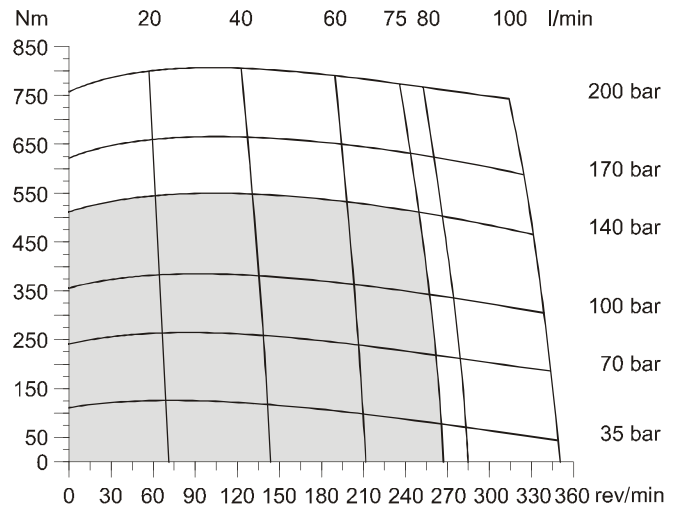

TF 360

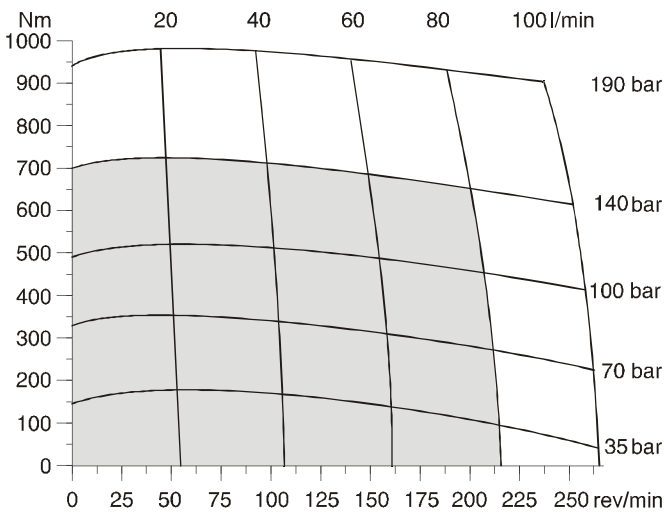

TF 405

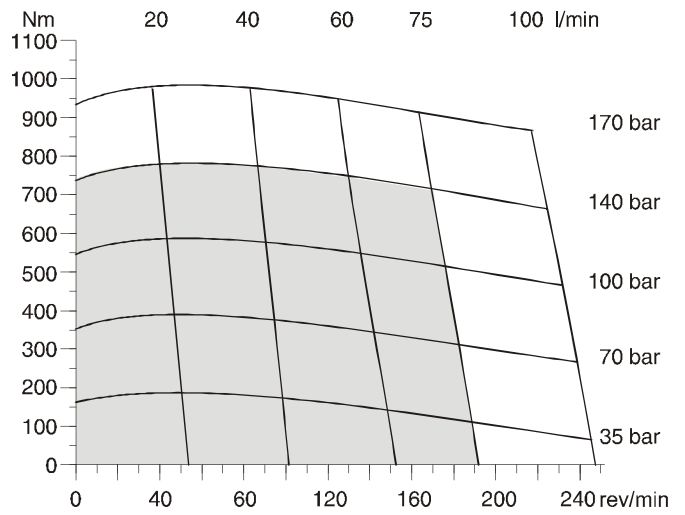

TF475

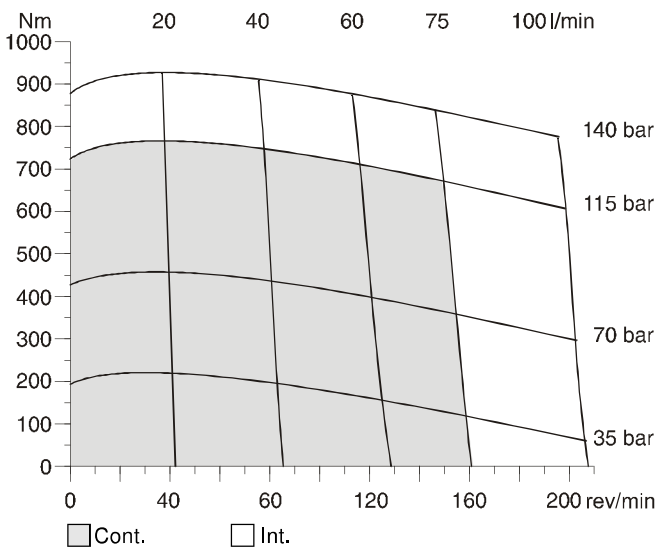

int. =
 Intermittierende Werte maximal: 10% von jeder Betriebsminute.
 Intermittent operation rating applies to 10% of every minute.
 Fonctionnement interm.: 10% max. de chaque minute d'utilisation.
 Servizio intermittente: 10% max di ogni minuto di utilizzazione.

Code E

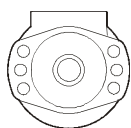

$$L_h = \frac{\left(\frac{670000}{F_R \cdot \left(1.10 + \frac{L}{88\text{mm}} \right)} \right)^{3.3}}{n}$$

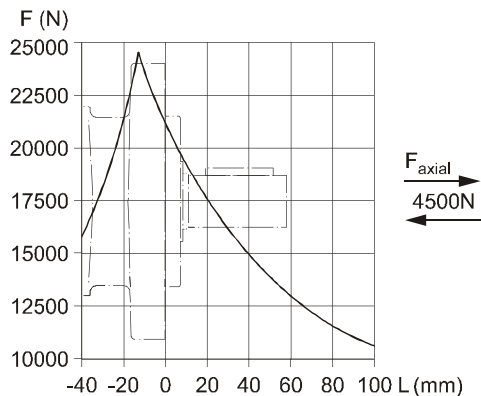

Code M

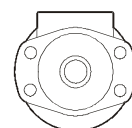

$$L_h = \frac{\left(\frac{670000}{F_R \cdot \left(1.16 + \frac{L}{88\text{mm}} \right)} \right)^{3.3}}{n}$$

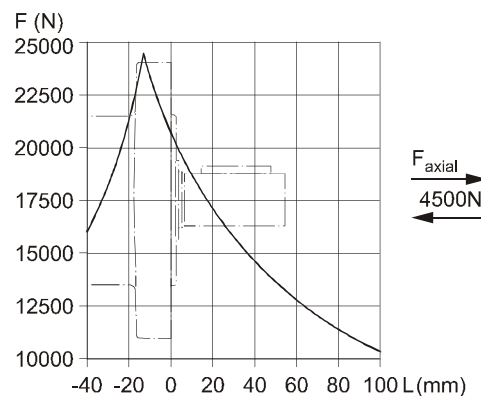

Code H

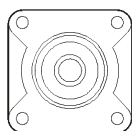

$$L_h = \frac{\left(\frac{670000}{F_R \cdot \left(0.56 + \frac{L}{88\text{mm}} \right)} \right)^{3.3}}{n}$$

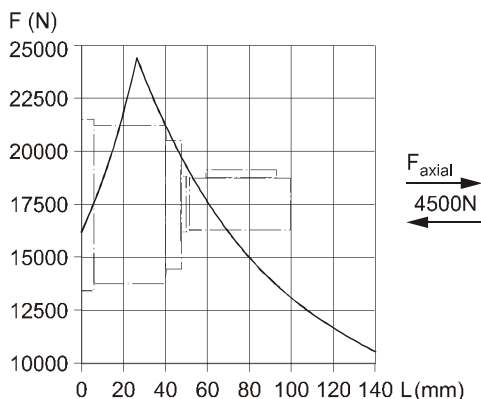

Code V

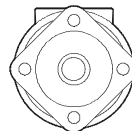

$$L_h = \frac{\left(\frac{670000}{F_R \cdot \left(1.11 + \frac{L}{88\text{mm}} \right)} \right)^{3.3}}{n}$$

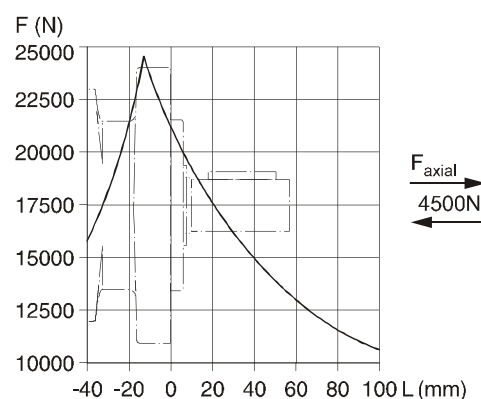

Die Lebensdauer der Radiallager (L_h in Stunden) läßt sich nach folgender Formel berechnen. Die Größe F_R ist durch die mechanische Festigkeit der Abtriebswelle begrenzt (siehe Diagramm). Das Maß "L" ist das Längenmaß vom Gehäuseflansch bis zum Angriffspunkt der Radialkraft F_R .

La durée de vie des roulements radiaux (L_h en heures) peut être calculée par les formules suivantes. La grandeur F_R est limitée par les résistances mécaniques de l'arbre de sortie (voir diagramme). La cote "L" est la longueur entre la bride du carter jusqu'au point d'appui de l'effort radial F_R .

Life time (L_h in hours) of the radial bearings can be calculated with the following formula. The value F_R is limited by the mechanical strength of the shaft (see diagram). The measurement "L" is the length from the housing flange up to the point of impact of the radial force F_R .

La durata dei cuscinetti (L_h in ore) può essere calcolata con la seguente formula. Il valore F_R è limitato dalla resistenza meccanica dell'albero (vedi diagramma). La quota "L" è la distanza tra la flangia del corpo ed il punto di applicazione della forza radiale F_R .

Vorstehende Formeln gelten für eine B10-Lebensdauer.
The preceding formulas are valid for a B10 duration of life.
Les formules précédentes sont valables pour une durée de vie B10.
Le formule precedenti sono valide per una durata della vita B10.

L_h = h
 L = mm
 F_R = F (N)
 n = rev/min

TF								A A A B
Serie Series Série Serie	Schluckvolumen Displacement Cylindrée Cilindrata	Gehäuse Housing Carter Corpo motore	Anschluß Ports Plan de raccordement Conessioni	Welle Shaft Arbre Albero	Drehrichtung Direction of rotation Direction de rotation Direzione di rotazione	Option code		

Code	cm ³ /rev
0080	81
0100	100
0130	128
0140	141
0170	169
0195	195
0240	237
0280	280
0360	364
0405	405
0475	477

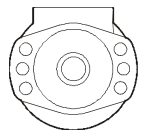
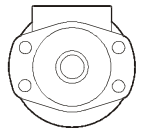
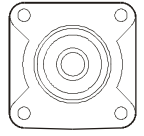
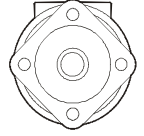

Code	Housing
E	
M	
H	
V ¹⁾	

Code	Front port
W	G 1/2
V	7/8-14 UNF O-Ring
N ²⁾	Universal- M8x13
K ³⁾	Universal- M6x12

²⁾ Nicht verfügbar für Gehäuse "H"
 Not possible for housing "H"
 Pas disponible pour carter "H"
 Non disponibile con il corpo codice "H"

³⁾ Nicht verfügbar für Gehäuse "M, E, V"
 Not possible for housing "M, E, V"
 Pas disponible pour carter "M, E, V"
 Non disponibile con il corpo codice "M, E, V"

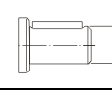
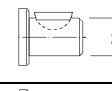
Code	Rear port
Y	G 1/2 Axial
A	7/8-14 UNF Axial
X	G 1/2 Radial
B	7/8-14 UNF Radial
L	Universal Radial M8x13

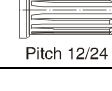
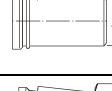
Code	Shaft
26	
47	
41	6B SAE
44	Pitch 12/24
45	
08	
46	

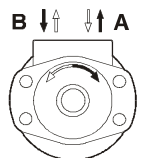
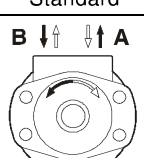
Code	Front port
0	 Standard
1	

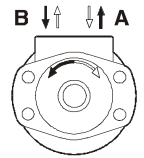
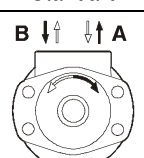
Code	Rear port
0	 Standard
1	

For further options different to standard 'AAAB' see page 57.