

Characteristics

Directional Control Valve Series D3W (Parker), 4D02 (Denison)

The direct operated directional control valve size NG10 is available with both Parker (series D3W) and Denison (series 4D02) model codes.

Both series are available with a soft shift option for smooth operation. An additional orifice in the solenoid anchor dampens the shifting time for D3W. For the 4D02 the orifice is located in the valve body.

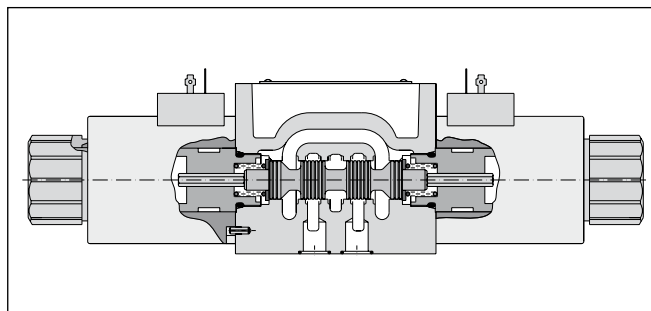
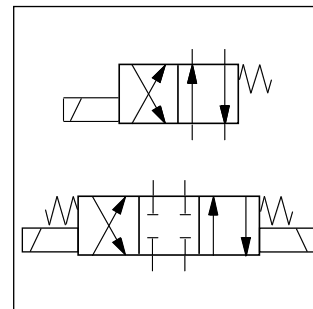

2

Technical data

General							
Design		Directional spool valve					
Actuation		Solenoid					
Size		DIN NG10 / CETOP 05 / NFPA D05					
Mounting interface		DIN 24340 A10 / ISO 4401 / CETOP RP 121-H / NFPA D05					
Mounting position		unrestricted, preferably horizontal					
Ambient temperature	[°C]	-25...+50					
Weight	[kg]	4.8 (1 solenoid), 6.3 (2 solenoids)					
Hydraulic							
Max. operating pressure	[bar]	P, A B: 350; T: 210 (DC), 105 (AC), 210 (AC Code "H")					
Fluid		Hydraulic oil in accordance with DIN 51524 / 51525					
Fluid temperature	[°C]	-25 ... +70					
Viscosity permitted	[cSt] / [mm²/s]	2.8...400					
Viscosity recommended	[cSt] / [mm²/s]	30...80					
Filtration		ISO 4406 (1999); 18/16/13 (meet NAS 1638: 7)					
Flow max.	[l/min]	150 (DC); 115 (AC)					
Leakage at 50 bar	[ml/min]	Up to 20 per flow path, depending on spool					
Static / Dynamic							
Step response		see table response time					
Electrical characteristics							
Duty ratio		100% ED; CAUTION: coil temperature up to 150 °C possible					
Max. switching frequency	[1/h]	10000					
Protection class		IP 65 in accordance with EN 60529 (plugged and mounted)					
	Code	K	J	U	G	Y	T
Supply voltage / ripple	[V]	12 V =	24 V =	98 V =	205 V =	110V at 50Hz/ 120V at 60Hz	230V at 50Hz/ 240V at 60Hz
Tolerance supply voltage	[%]	±10	±10	±10	±10	±5	±5
Current consumption hold	[A]	3	1.5	0.37	0.18	0.8 / 0.72	0.4 / 0.36
Current consumption in rush	[A]	3	1.5	0.37	0.18	3.41 / 3.31	1.75 / 1.7
Power consumption hold	[W]	36	36	36	36	88 / 86	88 / 86
Power consumption in rush	[W]	36	36	36	36	375 / 397	385 / 408
Solenoid connection		Connector as per EN 175301-803, solenoid identification as per ISO 9461.					
Wiring min.	[mm²]	3 x 1.5 recommended					
Wiring length max.	[m]	50 recommended					

With electrical connections the protective conductor (PE \downarrow) must be connected according to the relevant regulations.

D3W stand_UK.INDD CM_21.01.2008.1

2

D

Directional control valve

3

**Size
 DIN NG10
 CETOP 05
 NFPA D05**

W

Wet pin solenoid

Spool type

Spool position

Seals

3 position spools	
Code	Spool type
	a 0 b
1	
2	
3	
4	
5	
6	
7	
8 ¹⁾	
9 ¹⁾	
10 ²⁾	
11	
12	
14	
15	
16	
21 ²⁾	
22 ²⁾	
31 ²⁾	
32 ²⁾	
81 ²⁾	
82 ²⁾	
102 ²⁾	

2 position spools	
Code	Spool type
	a b
20	
26	
30	
101 ²⁾	

Code	Seals
N	NBR
V	FPM

3 position spools		
Code	all 3 position spools	
C		3 positions. Spring offset in position "0". Operated in position "a" or "b".
	Standard	Spool type 8 and 9
E		2 positions. Spring offset in position "0".
	Operated in position "a".	Operated in position "b".
F		2 positions. Operated in position "0".
	Spring offset in position "b".	Spring offset in position "a".
K		2 positions. Spring offset in position "0".
	Operated in position "b".	Operated in position "a".
M		2 positions. Operated in position "0".
	Spring offset in position "a".	Spring offset in position "b".

2 position spools		
Code	Spool position	
B		2 positions. Spring offset in position "b". Operated in position "a".
D		2 positions. Operated in position "a" or "b". No centre or offset position.
H		2 positions. Spring offset in position "a". Operated in position "b".

**Bold letters =
 Short-term availability**

¹⁾ Consider specific spool position.
²⁾ Only available for DC voltage.

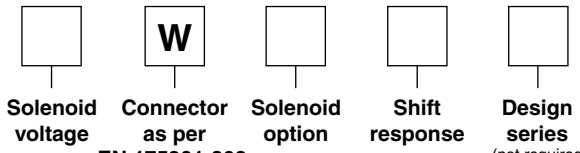

Connector as per EN 175301-803, without plug
 (Please order plug separately)

Code	Solenoid voltage
K	12V =
J	24V =
U ³⁾	98V =
G ³⁾	205V =
Y	110V 50Hz / 120V 60Hz
T	230V 50Hz / 240V 60Hz

³⁾ To be used with rectifier plug when DC solenoids are used with AC input.

Code	Shift response
omit	Standard response
S4 ⁴⁾	orifice diameter 1.0 mm
S7 ⁴⁾	orifice diameter 1.5 mm

⁴⁾ Only for DC

Code	Solenoid option
omit	Standard solenoid with manual override
H	High pressure solenoid tube for AC. Tank pressure up to 210bar
T	without manual override



The Parker model code should be used for all new applications. Otherwise also refer to Denison model code.

Further spool types and solenoid voltages on request.

2

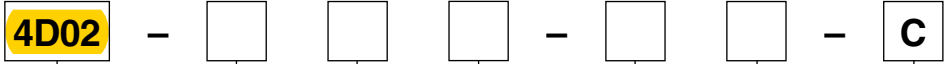

4D02
 Directional control valve size
 DIN NG10
 CETOP 05
 NFPA D05

Body

Control

Spool type

Spool position

End cap

Design series

Code	Body
3	Standard 3-chamber
D	5-chamber for soft-shift (G3)

Code	Control
1	1 solenoid
2	2 solenoids
7	2 solenoids and 2 pos. detent (only for spool types 11 and 51)

Code	End cap
01	for control 1
02	for control 2 and 7

3 position spools	
Code	Spool type
01	a 0 b
02	
03	
07	
08	
09	
10	
46	
55	
56	

2 position spools	
Code	Spool type
11	a b
12	
51	

3 position spools		
Code	Spool position	
03		3 positions. Spring centered to "0".
05		2 positions. Spring centered energized to "b".
06		2 positions. Spring centered energized to "a".

2 position spools		
Code	Spool position	
01		2 positions. Spring offset to "b" energized to "a".
02		2 positions. Spring offset to "a" energized to "b".
09		2 positions detent. Operated in "a" or "b". No centre or spring offset position.



Ordering Code

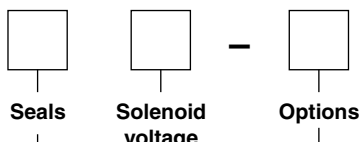

Code	Seals
1	NBR
5	FPM

Code	Solenoid voltage
G0R	12V =
G0Q	24V =
GAR *	98V =
GAG *	205V =
W30	110V 50Hz / 120V 60Hz
W31	230V 50Hz / 240V 60Hz

* To be used with rectifier plug when DC solenoids are used with AC input.

Code	Options
omit	Solenoid connector as per EN 175301-803 without plug. With manual override
G3	Soft shift with orifice in body (for DC and body D only)
32	Without manual override

DENISON	Hydraulics
<p>The Denison model code is available for existing applications. For new applications we advise to refer to Parker model code.</p>	

Further spool types and solenoid voltages on request.

The flow curve diagram shows the flow versus pressure drop curves for all spool types. For each spool type,

operating position and flow direction the relevant curve number is given in the table below.

Spool		Position „b“		Position „a“		Position „0“					
D3W	4D02	P->A	B->T	P->B	A->T	P->A	P->B	A->T	B->T	P->T	A->B
1	03	4	3	4	3	-	-	-	-	-	-
2	01	4	1	4	1	3	3	1	1	5	1
3	10	4	3	5	2	-	-	4	-	-	-
4	08	4	2	4	2	-	-	3	3	-	5
5	-	4	3	5	3	5	-	-	-	-	-
6	46	4	3	4	3	6	6	-	-	-	6
7	-	5	1	4	3	-	4	-	2	6	-
10	-	4	-	4	-	-	-	-	-	-	-
11	02	4	3	4	3	-	-	8	8	-	-
12	-	4	3	4	3	7	7	7	7	8	8
14	-	4	3	5	1	4	-	2	-	6	-
15	09	5	2	4	3	-	-	-	4	-	-
16	-	5	3	4	3	-	5	-	-	-	-
20	51	4	3	4	3	-	-	-	-	-	-
26	12	4	-	4	-	-	-	-	-	-	-
30	11	4	2	4	2	-	-	-	-	-	-
		P->B	A->T	P->A	B->T	P->A	P->B	A->T	B->T	P->T	A->B
8	-	4	3	4	3	-	-	-	-	6	-
9	07	4	4	4	4	-	-	-	-	6	-
		Position „b“		Position „a“							
		P->A	P->B	A->B	P->B	A->T					
21	55	5	4	6	3	3					
		P->A	B->T		P->A	P->B	A->B				
22	56	3	3		4	5	6				

Flow curve diagram

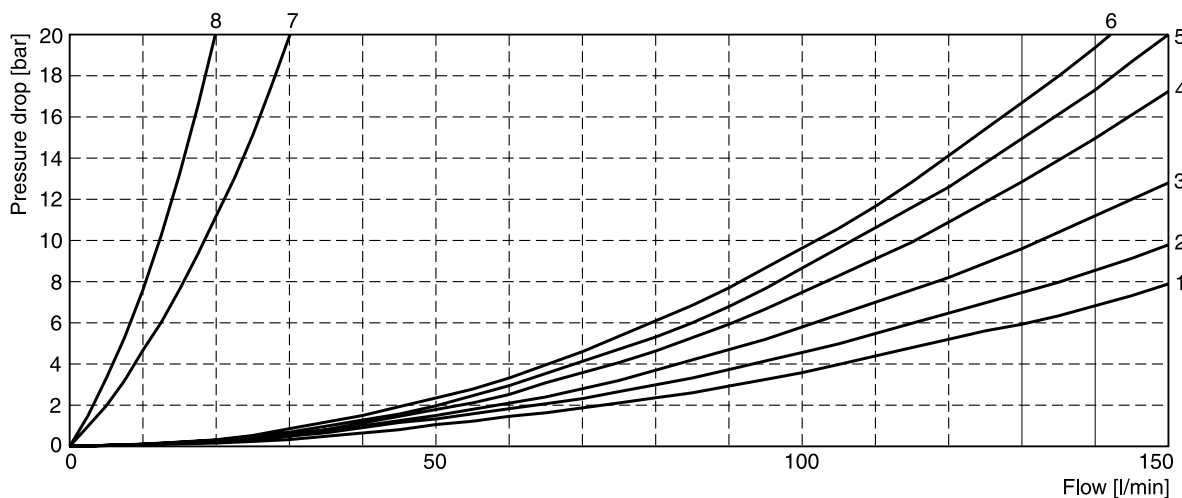

The diagram below specifies the shift limits for valves with DC and AC solenoids. Valves with spool position "F" or "M" can only be operated up to 70% of the limits. The specifications apply to a viscosity 35mm²/s and bal-

anced flow conditions. The shift limits can be considerably lower at unbalanced flow conditions. To avoid flow rates beyond the shift limits, a plug-in orifice can be inserted in the P-port.

Shift limits, DC voltage *

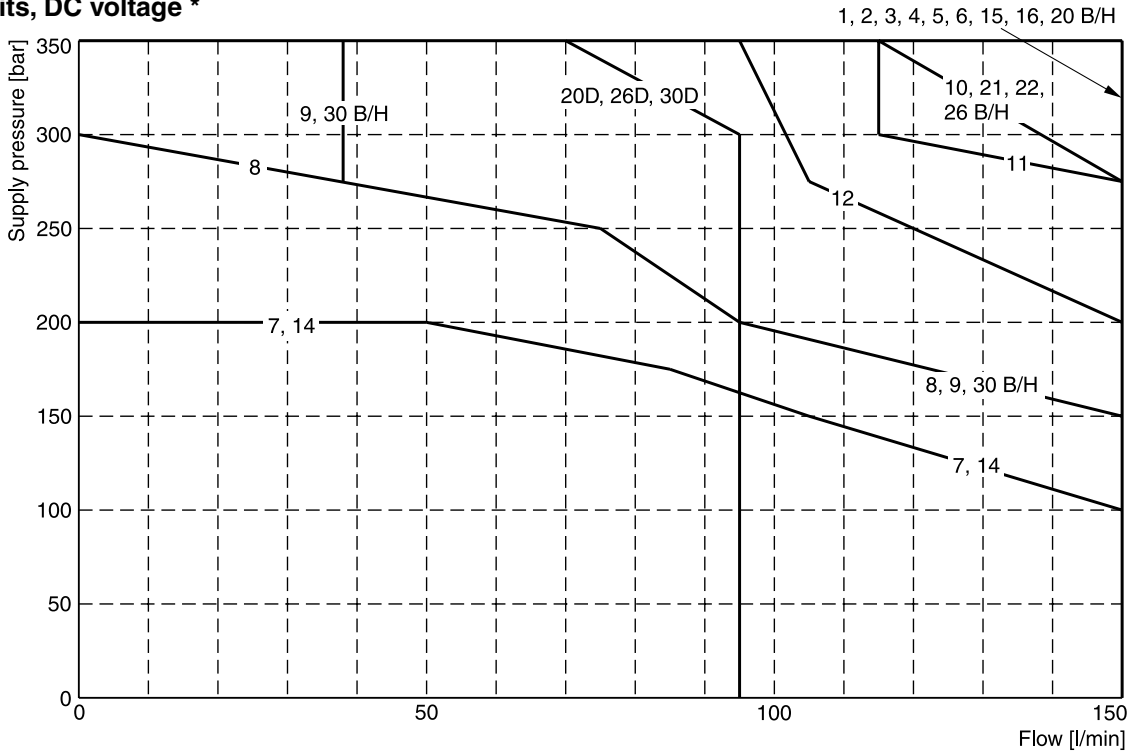

Shift limits, AC voltage *

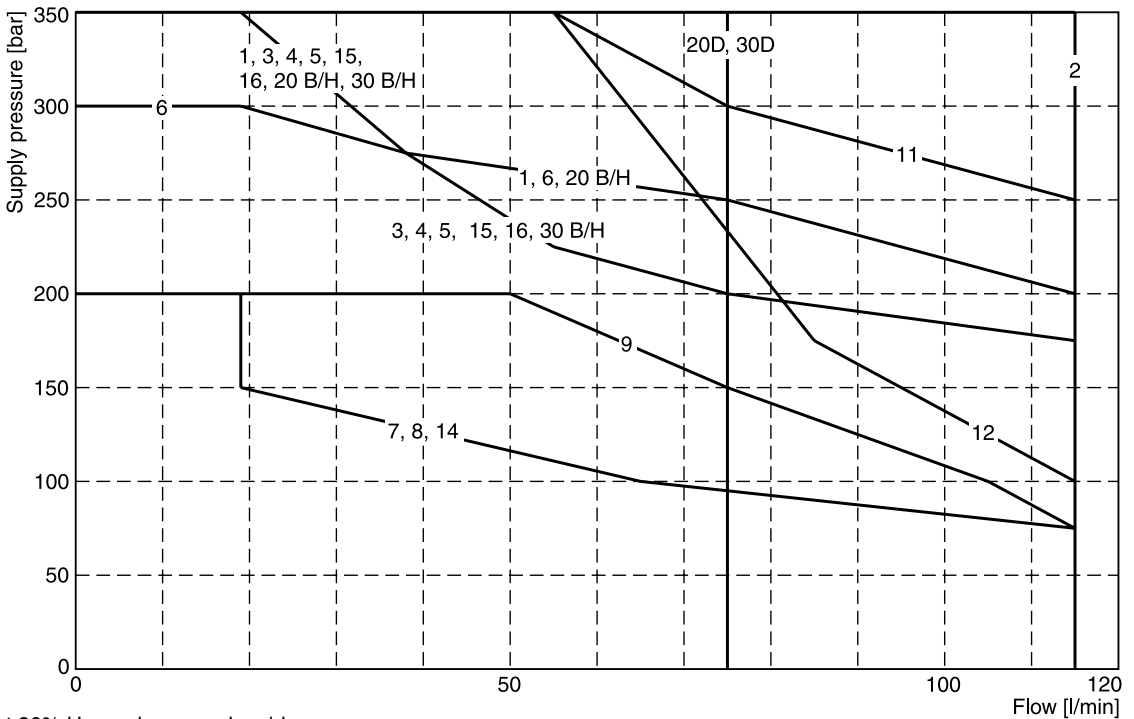

Measured at 90% U_{nom} and warm solenoids.

* For 4D02 spool code see flow curve table.

D3W stand_UK.INDD CM_21.01.2008.1

Shift limits soft shift

The diagram below specifies the shift limits. Valves with spool position “F” or “M” can only be operated up to 70% of the limits. The specifications apply to a viscosity 35mm²/s and balanced flow conditions. The shift limits can

be considerably lower at unbalanced flow conditions. To avoid flow rates beyond the shift limits, a plug-in orifice can be inserted in the P-port.

2

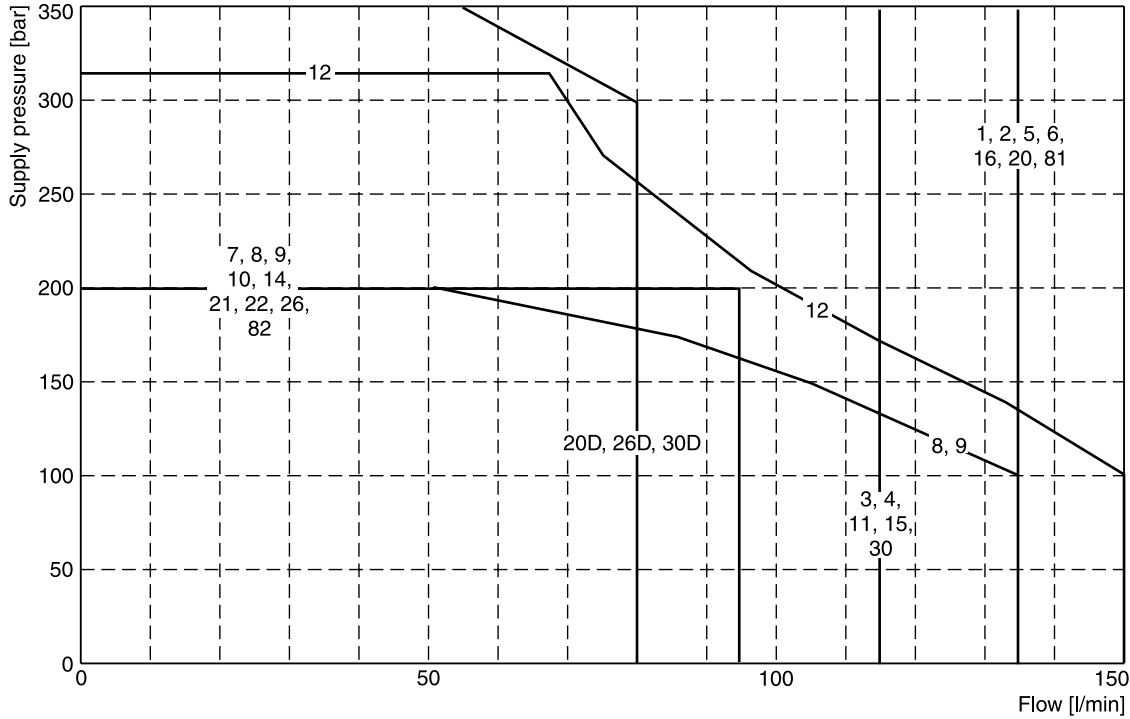

Measured at 90% U_{nom} and warm solenoids.

Response times D3W Soft Shift

Code	Orifice size	Energize	De-energize
(Standard)	–	105 ms (DC) 21 ms (AC)*	85 ms (DC) 35 ms (AC)*
S4	1.0 mm	320 ms	550 ms
S7	1.75 mm	160 ms	370 ms

Step response times were obtained under the following conditions: $\nu = 35 \text{ mm}^2/\text{s}$ at 50°C with the valve operating at 175 bar and 65 l/min. Published response times are nominal and may vary with spool, flow, pressure and temperature.

* For AC input and soft shift use rectifier plug.

Acceleration for different orifice sizes (archived against a valve without soft shift)

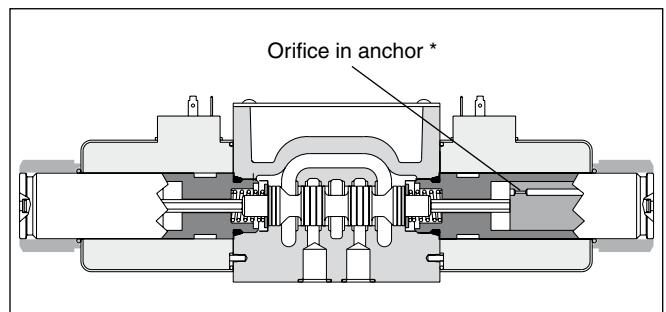
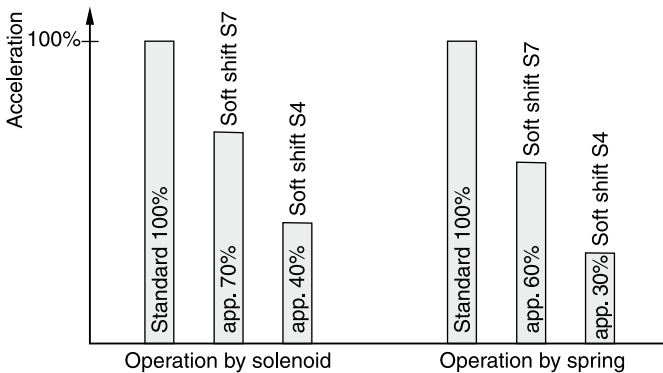

* Note: For 4D02 the orifice is located in the Z-channel of the valve body.

For even softer shifting, the proportional spools 81, 82, 101 and 102 can be used.

Interface EN 175301-803, DC solenoid
B, E, F -style

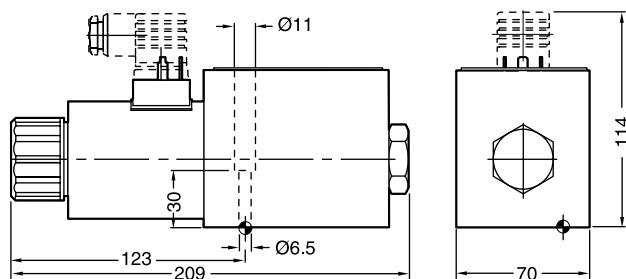

H, K, M -style

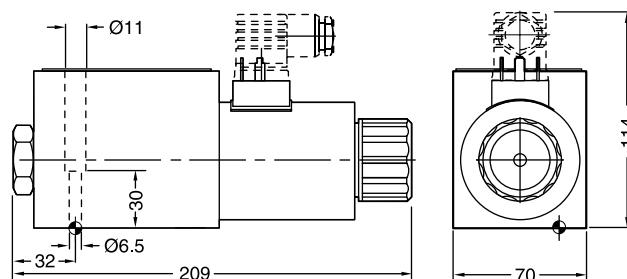

C, D -style

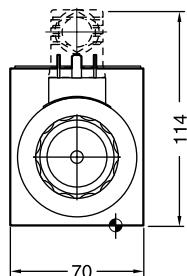
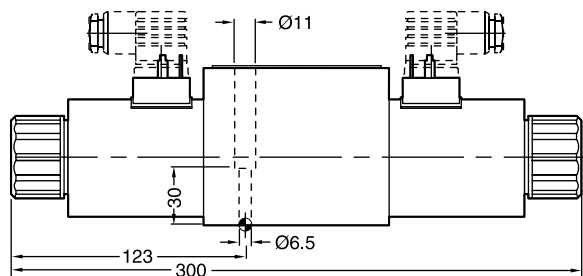

Interface EN 175301-803, AC solenoid
B, E, F -style

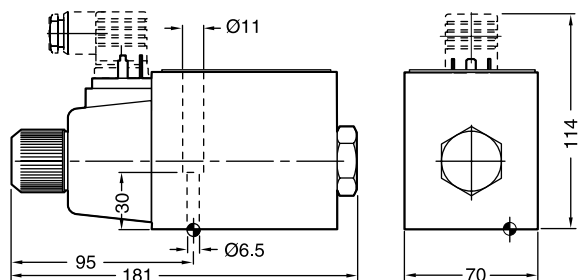



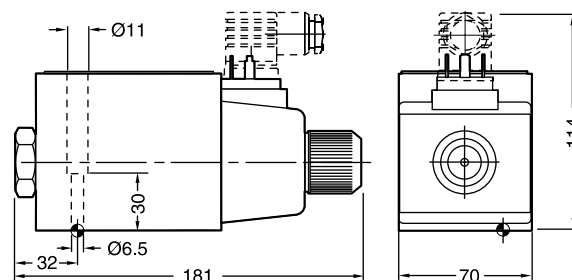

H, K, M -style

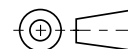
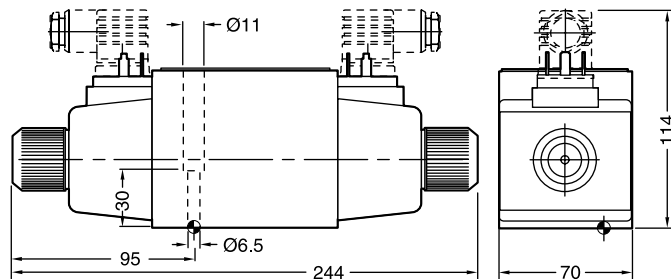

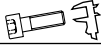
C, D -style

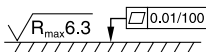

Surface finish	 Kit	 		 Kit
	BK385	4x M6x40 DIN 912 12.9	13.2 Nm ±15%	NBR: SK-D3W-30 FPM: SK-D3W-V30

The space necessary to remove the plug per EN 175301-803, design type AF is at least 15 mm.
 The torque for the screw M3 of the plug has to be 0.5 to 0.6 Nm.

D3W stand_UK.INDD CM_21.01.2008.1

